



# VME421H



**Voltage and frequency monitor** for monitoring AC/DC systems for undervoltage, overvoltage, underfrequency and overfrequency  
Software version VME421H-D-1: D236 V2.2x  
Software version VME421H-D-2: D237 V2.2x



**Bender GmbH & Co. KG**

P.O. Box 1161 • 35301 Gruenberg • Germany  
Londorfer Strasse 65 • 35305 Gruenberg • Germany  
Tel.: +49 6401 807-0 • Fax: +49 6401 807-259  
E-Mail: [info@bender.de](mailto:info@bender.de) • [www.bender.de](http://www.bender.de)

© Bender GmbH & Co. KG

All rights reserved.  
Reprinting only with permission of the publisher.  
Subject to change!

Photos: Bender archives

## Table of Contents

<b>1. Important information</b>	<b>5</b>
1.1 How to use this manual	5
1.2 Technical support: service and support	6
1.2.1 First level support	6
1.2.2 Repair service	6
1.2.3 Field service	7
1.3 Training courses	8
1.4 Delivery conditions	8
1.5 Inspection, transport and storage	8
1.6 Warranty and liability	9
1.7 Disposal	10
<b>2. Safety instructions</b>	<b>11</b>
2.1 General safety instructions	11
2.2 Work activities on electrical installations	11
2.3 Intended use	12
<b>3. Function</b>	<b>13</b>
3.1 Device features	13
3.2 Function	13
3.2.1 Preset function	14
3.2.2 Automatic self test	15
3.2.3 Manual self test	15
3.2.4 Malfunction	15
3.2.5 Fault memory	15
3.2.6 Assigning alarms to the alarm relays K/1K2	16
3.2.7 Time delays $t$ , $t_{on}$ and $t_{off}$	16
3.2.8 Password protection (on, OFF)	16
3.2.9 Factory setting FAC	17

3.2.10 Erasable history memory .....	17
3.2.11 Alarm LEDs show which relay is in the alarm state .....	17
3.2.12 Starting a device using a simulated alarm S.AL .....	18
<b>4. Installation and connection .....</b>	<b>19</b>
<b>5. Operation and setting .....</b>	<b>21</b>
5.1 Fast commissioning for $U_n = 230\text{ V}$ , 50 Hz .....	21
5.2 Display elements in use .....	22
5.3 Function of the operating elements .....	23
5.4 Menu structure .....	24
5.5 Display in standard mode .....	26
5.6 Display in menu mode .....	27
5.6.1 Parameter query and setting: Overview .....	27
5.6.2 Setting the response values for undervoltage, overvoltage and hysteresis .....	30
5.6.3 Setting the response values for underfrequency, overfrequency and hysteresis .....	31
5.6.4 Setting the fault memory and operating principle of the alarm relays .....	32
5.6.5 Assigning alarm categories to the alarm relays .....	34
5.6.6 Setting the time delay .....	36
5.6.7 Factory setting and password protection .....	37
5.6.8 Restoring factory settings .....	38
5.6.9 Manual activation of the preset function .....	39
5.6.10 Device information query .....	39
5.6.11 History memory query .....	39
5.7 Preset function/ factory setting .....	40
5.8 Commissioning .....	40
<b>6. Technical data VME421H... .....</b>	<b>41</b>
6.1 Ordering information .....	45
6.2 Standards, approvals and certifications .....	45
<b>INDEX .....</b>	<b>47</b>

# 1. Important information

## 1.1 How to use this manual



This manual is intended for **qualified personnel** working in electrical engineering and electronics!

### Always keep this manual within easy reach for future reference.

To make it easier for you to understand and revisit certain sections in this manual, we have used symbols to identify important instructions and information. The meaning of these symbols is explained below:



This signal word indicates that there is a **high risk of danger** that will result in **electrocution** or **serious injury** if not avoided.



This signal word indicates a **medium risk of danger** that can lead to **death** or **serious injury** if not avoided.



This signal word indicates a **low level risk** that can result in **minor** or **moderate injury or damage to property** if not avoided.



This symbol denotes information intended to assist the user in making **optimum use** of the product.

This manual has been compiled with great care. It might nevertheless contain errors and mistakes. Bender cannot accept any liability for injury to persons or damage to property resulting from errors or mistakes in this manual.

## 1.2 Technical support: service and support

For commissioning and troubleshooting Bender offers you:

### 1.2.1 First level support

Technical support by phone or e-mail for all Bender products

- Questions concerning specific customer applications
- Commissioning
- Troubleshooting

**Telephone:** +49 6401 807-760\*  
**Fax:** +49 6401 807-259  
In Germany only: 0700BenderHelp (Tel. and Fax)  
**E-mail:** support@bender-service.de

### 1.2.2 Repair service

Repair, calibration, update and replacement service for Bender products

- Repairing, calibrating, testing and analysing Bender products
- Hardware and software update for Bender devices
- Delivery of replacement devices in the event of faulty or incorrectly delivered Bender devices
- Extended guarantee for Bender devices, which includes an in-house repair service or replacement devices at no extra cost

**Telephone:** +49 6401 807-780\*\* (technical issues)  
+49 6401 807-784\*\*, -785\*\* (sales)  
**Fax:** +49 6401 807-789  
**E-mail:** repair@bender-service.de

Please send the devices for **repair** to the following address:

Bender GmbH, Repair-Service,  
Londorfer Str. 65,  
35305 Gruenberg

### 1.2.3 Field service

On-site service for all Bender products

- Commissioning, configuring, maintenance, troubleshooting of Bender products
- Analysis of the electrical installation in the building (power quality test, EMC test, thermography)
- Training courses for customers

**Telephone:** +49 6401 807-752\*\*, -762 \*\*(technical issues)

+49 6401 807-753\*\* (sales)

**Fax:** +49 6401 807-759

**E-mail:** [fieldservice@bender-service.de](mailto:fieldservice@bender-service.de)

**Internet:** [www.bender-de.com](http://www.bender-de.com)

\*Available from 7.00 a.m. to 8.00 p.m. 365 days a year (CET/UTC+1)

\*\*Mo-Thu 7.00 a.m. - 8.00 p.m., Fr 7.00 a.m. - 13.00 p.m

### 1.3 Training courses

Bender is happy to provide training regarding the use of test equipment. The dates of training courses and workshops can be found on the Internet at [www.bender-de.com](http://www.bender-de.com) -> Know-how -> Seminars.

### 1.4 Delivery conditions

Bender sale and delivery conditions apply.

For software products the "Softwareklausel zur Überlassung von Standard-Software als Teil von Lieferungen, Ergänzung und Änderung der Allgemeinen Lieferbedingungen für Erzeugnisse und Leistungen der Elektroindustrie" (software clause in respect of the licensing of standard software as part of deliveries, modifications and changes to general delivery conditions for products and services in the electrical industry) set out by the ZVEI (Zentralverband Elektrotechnik- und Elektronikindustrie e. V.) (German Electrical and Electronic Manufacturer's Association) also applies.

Sale and delivery conditions can be obtained from Bender in printed or electronic format.

### 1.5 Inspection, transport and storage

Inspect the dispatch and equipment packaging for damage, and compare the contents of the package with the delivery documents. In the event of damage in transit, please contact Bender immediately.

The devices must only be stored in areas where they are protected from dust, damp, and spray and dripping water, and in which the specified storage temperatures can be ensured.



## 1.6 Warranty and liability

Warranty and liability claims in the event of injury to persons or damage to property are excluded if they can be attributed to one or more of the following causes:

- Improper use of the device.
- Incorrect mounting, commissioning, operation and maintenance of the device.
- Failure to observe the instructions in this operating manual regarding transport, commissioning, operation and maintenance of the device.
- Unauthorised changes to the device made by parties other than the manufacturer.
- Non-observance of technical data.
- Repairs carried out incorrectly and the use of replacement parts or accessories not approved by the manufacturer.
- Catastrophes caused by external influences and force majeure.
- Mounting and installation with device combinations not recommended by the manufacturer.

This operating manual, especially the safety instructions, must be observed by all personnel working on the device. Furthermore, the rules and regulations that apply for accident prevention at the place of use must be observed.

## 1.7 Disposal

Abide by the national regulations and laws governing the disposal of this device. Ask your supplier if you are not sure how to dispose of the old equipment.

The directive on waste electrical and electronic equipment (WEEE directive) and the directive on the restriction of certain hazardous substances in electrical and electronic equipment (RoHS directive) apply in the European Community. In Germany, these policies are implemented through the "Electrical and Electronic Equipment Act" (ElektroG). According to this, the following applies:

- Electrical and electronic equipment are not part of household waste.
- Batteries and accumulators are not part of household waste and must be disposed of in accordance with the regulations.
- Old electrical and electronic equipment from users other than private households which was introduced to the market after 13 August 2005 must be taken back by the manufacturer and disposed of properly.

For more information on the disposal of Bender devices, refer to our homepage at [www.bender-de.com](http://www.bender-de.com) -> Service & support.

## 2. Safety instructions

### 2.1 General safety instructions

Part of the device documentation in addition to this manual is the enclosed "Safety instructions for Bender products".

### 2.2 Work activities on electrical installations



Only **qualified personnel** are permitted to carry out the work necessary to install, commission and run a device or system.



**DANGER**

#### **Risk of electrocution due to electric shock!**

Touching live parts of the system carries the risk of:

- An electric shock
- Damage to the electrical installation
- Destruction of the device

**Before installing and connecting the device, make sure that the installation has been *de-energised*.** Observe the rules for working on electrical installations.

If the device is used outside the Federal Republic of Germany, the applicable local standards and regulations must be complied with. The European standard EN 50110 can be used as a guide.

## 2.3 Intended use

The voltage monitor VME421H monitors AC/DC systems in the frequency range of DC/15...460 Hz for undervoltage, overvoltage, underfrequency or overfrequency. Device variant **-1** is suitable for the nominal voltage range  $U_n = 9.6...150\text{ V}$ , device variant **-2** for  $U_n = 70...300\text{ V}$ . The supply voltage is taken from the nominal voltage being monitored  $U_n$ .

In order to meet the requirements of the applicable standards, customised parameter settings must be made on the equipment in order to adapt it to local equipment and operating conditions. Please heed the limits of the range of application indicated in the technical data.

Any use other than that described in this manual is regarded as improper.

## 3. Function

### 3.1 Device features

- Undervoltage and overvoltage monitoring of AC/DC systems in the frequency range DC/15...460 Hz  
device variant -1: 9,6...150 V  
device variant -2: 70...300 V
- Preset function:  
Automatic response value setting for undervoltage and overvoltage,  $< U$  and  $> U$  as well as for underfrequency and overfrequ.  $< f$  and  $> f$
- Voltage and frequency monitoring with window discriminator function,  $< U$  and  $> U$  as well as  $< f$  and  $> f$
- Indication of the system frequency  $f$
- Starting delay, response delay and release delay
- Adjustable switching hysteresis for  $U$  and  $f$
- r.m.s. value measurement AC + DC
- Measured value display via multi-functional LC display
- Alarm indication via LEDs (AL1, AL2) and changeover contacts (K1, K2)
- N/C operation or N/O operation selectable
- Password protection against unauthorised parameter changing
- The fault memory can be activated or deactivated. In the "con" mode, all alarm parameters remain stored on failure of the nominal voltage being monitored ( $U_n = U_S$ )
- Start-up of the device with or without simulated alarm message

### 3.2 Function

Once the nominal voltage is applied, the starting delay " $t$ " is activated. Measured values changing during this time do not influence the switching state of the alarm relays.

The devices provide two separately adjustable measuring channels (overvoltage/undervoltage). When the measuring quantity exceeds the response value (Alarm 1) or falls below the response value (Alarm 2), the time of the response delays " $t_{on\ 1/2}$ " begins. After the expiry of the response delay, the alarm relays switch and the alarm LEDs light. If the measuring value exceeds or falls below the release value (response value plus hysteresis) after the alarm relays have switched, the selected release delay " $t_{off}$ " begins. After the expiry of " $t_{off}$ ", the alarm relays switch back to their initial position. With the fault memory activated, the alarm relays remain in alarm state until the reset button R is pressed. Also in the event of complete power failure of the system being monitored, the delay times are effective during the energy backup discharging time.

### 3.2.1 Preset function

After connecting the system to be monitored for the first time, the response values for overvoltage and undervoltage (Alarm 1/2) are automatically set once to:

Response value overvoltage ( $> U$ ):  $1.1 U_n$

Response value undervoltage ( $< U$ ):  $0.85 U_n$

Response value overfrequency ( $> f$ ) at 16.7 Hz, 50 Hz, 60 Hz:  $f_n + 1$  Hz

Response value overfrequency ( $> f$ ) at 400 Hz:  $f_n + 1$  Hz

Response value underfrequency ( $< f$ ) at 16.7 Hz, 50 Hz, 60 Hz:  $f_n - 1$  Hz

Response value underfrequency ( $< f$ ) at 400 Hz:  $f_n - 1$  Hz

Preset VME421H-D-1 / VME421H-D-2				
$U_n$	Preset operating range	Response value $< U$	Response value $> U$	Device variant
230 V	196...253 V	196 V	253 V	<b>-2</b>
120 V	102...132 V	102 V	132 V	<b>-1, -2</b>
60 V	51...66 V	51 V	66 V	<b>-1</b>
24 V	20.4...26.4 V	20.4 V	26.4 V	<b>-1</b>

If the measured voltage is not within the preset operating range listed in the table, the message "AL not Set" appears on the display. Therefore it is necessary to set the response values for Alarm 1 (AL1) and Alarm 2 (AL2) manually. A detailed description of the process is given in the chapter "parameter setting".

After restoring the factory settings, the preset function is automatically active again.

During operation, the preset function can be started manually via the menu SEt.

### 3.2.2 Automatic self test

The device automatically carries out a self test after connection to the system to be monitored and later every hour. During the self test internal functional faults are detected and appear in form of an error code on the display. The alarm relays are not checked during this test.

### 3.2.3 Manual self test

After pressing the internal test button for  $> 1.5$  s, a self test is performed by the device. During this test, internal malfunction will be determined and appear in form of an error code on the display. The alarm relays are not checked during this test.

While the test button T is pressed and held down, all device-related display elements appear on the display.

### 3.2.4 Malfunction

If an internal functional fault occurs, all three LEDs flash. An error code will appear on the display (E01...E32). In such a case please contact the Bender Service.

### 3.2.5 Fault memory

The fault memory can be activated, deactivated or can be set to continuous mode (con). If the fault memory is set to "con" mode, the stored alarm parameters remain stored also in the event of failure of the nominal voltage ( $U_n = U_S$ ) and also when the energy backup discharging time has elapsed.

### 3.2.6 Assigning alarms to the alarm relays K1/K2

Different alarm categories can be assigned to the alarm relays K1/K2 via the menu "out".

### 3.2.7 Time delays $t$ , $t_{\text{on}}$ and $t_{\text{off}}$

The times  $t$ ,  $t_{\text{on}}$  and  $t_{\text{off}}$  described below delay the output of alarms via LEDs and relays.

#### Starting delay $t$

After connection to the voltage  $U_n$  to be monitored, the alarm indication is delayed by the preset time  $t$  (0...300 s).

#### Response delay $t_{\text{on}}$

When the response value is reached, the voltage monitor requires the response time  $t_{\text{an}}$  until the alarm is activated.

A preset response delay  $t_{\text{on}}$  (0...300 s) adds up to the device-related operating time  $t_{\text{ae}}$  and delays alarm signalling (total delay time  $t_{\text{an}} = t_{\text{ae}} + t_{\text{on}}$ ).

If the fault does not continue to exist before the time of the response delay has elapsed, an alarm will not be signalled.

#### Release delay $t_{\text{off}}$

When no alarm exists after deactivating the fault memory, the alarm LEDs will go out and the alarm relays switch back to their initial position. After activating the release delay (0...300 s), the alarm state is continuously maintained for the selected period.

### 3.2.8 Password protection (on, OFF)

With the password protection activated (on), settings are only possible after entering the correct password (0...999).

If you cannot operate your device because you cannot remember your password, please contact [info@bender-service.de](mailto:info@bender-service.de).



### 3.2.9 Factory setting FAC

After activating the factory setting, all settings previously changed are reset to delivery status. In addition, the preset function allows automatic adaptation of the response values in relation to the nominal voltage  $U_n$ .

### 3.2.10 Erasable history memory

The first alarm value that occurs will be stored in this memory. Subsequent alarms do not overwrite this "old" value. The memory can be cleared using the Clr key in the menu HiS.

### 3.2.11 Alarm LEDs show which relay is in the alarm state

When the menu item **LEd**  is activated, the alarm LED AL1 indicates that K1 is in the alarm state. When AL2 lights up, K2 is in the alarm state. An alarm relay cannot switch to the alarm state unless an alarm category has been assigned to it.

When the menu item **LEd**  is deactivated, **AL1 signals overvoltage, AL2 signals undervoltage.**

Both LEDs AL1 and AL2 light up in case of frequency alarm.

For details about alarm category assignment to the respective relays refer to the submenu out description on page 25.

### 3.2.12 Starting a device using a simulated alarm S.AL

If the menu item S.AL has been activated in the out menu, K1 resp. K2 switches back to the alarm state once the supply voltage is applied. This alarm state is maintained for the set duration  $t + t_{on1}$ . Once this time has elapsed, K1 resp. K2 switches back to the initial position provided that no fault is detected at the measuring input.

The following diagrams show the effect of a fault during a simulated alarm.

Faults at the measuring input and the resulting condition of the alarm relay K1 (K2) are shown as a hatched area.

The fault for K1 shown in the time diagram below, by way of example, has started during the S.AL phase:

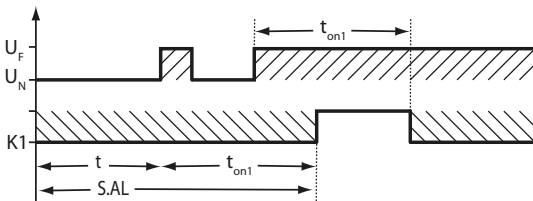

The fault for K1 shown in the time diagram below, by way of example, started when the S.AL phase has elapsed:

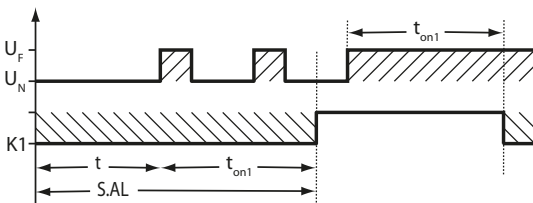

## 4. Installation and connection



Only **qualified personnel** are permitted to carry out the work necessary to install, commission and run a device or system.



**DANGER**

### **Risk of electrocution due to electric shock!**

Touching live parts of the system carries the risk of:

- An electric shock
- Damage to the electrical installation
- Destruction of the device

**Before installing and connecting the device, make sure that the installation has been de-energised.** Observe the rules for working on electrical installations.

General dimension diagram and drawing for screw fixing

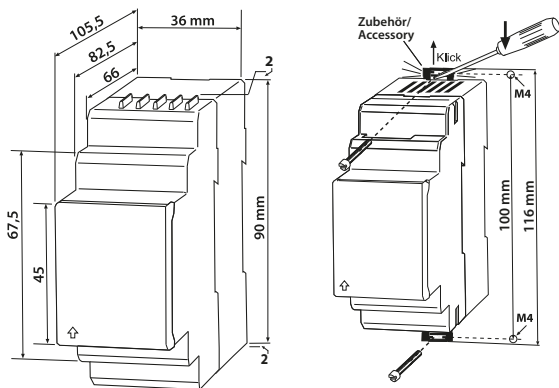

The front plate cover is easy to open at the lower part identified by an arrow.

### 1. DIN rail mounting:

Snap the rear mounting clip of the device into place in such a way that a safe and tight fit is ensured.

#### Screw fixing:

Use a tool to move the rear mounting clips (a second mounting clip is required, see ordering information) to a position that it projects beyond the enclosure. Then fix the device using two M4 screws.

### 2. Wiring

Connect the device according the wiring diagram.

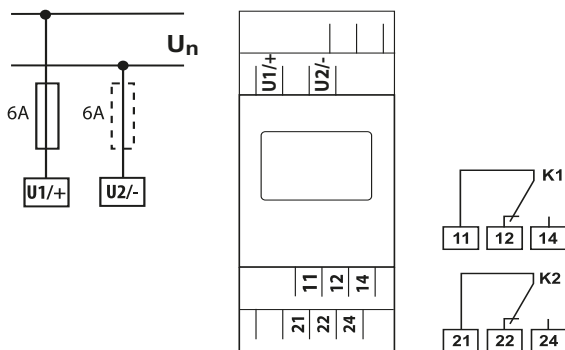

	Terminal	Connections
	U1+, U2/-	Connection to the system being monitored
	11, 12, 14	Alarm relay K1
	21, 22, 24	Alarm relay K2

## 5. Operation and setting

### 5.1 Fast commissioning for $U_n = 230\text{ V}$ , 50 Hz

If you are already familiar with voltage monitors, you can reduce the time for commissioning and connection using this brief description.

1. Check that device variant **-2** in the voltage range  $U_n = 70 \dots 300\text{ V}$  is used.
2. Check that the system being monitored is operated with a nominal voltage of  $U_n = 230\text{ V}$  and 50 Hz. This is the precondition for an automatic setting of the response values (Preset) after the first connection to the nominal voltage.
3. Make sure that the voltage monitor is in the delivery status (factory setting has not been changed). In case of doubt, restore the factory setting (page 38).
4. When the conditions 1, 2 and 3 are satisfied, you can connect the voltage monitor to the system to be monitored according to the wiring diagram (page 20). The following predefined response values will be set automatically:

VME421H-D-2			
$U_n, f_n$	Preset operating range	Response value $< U, < f$	Response value $> U, > f$
230 V	196 V...253 V	196 V	253 V
50 Hz	47...53 Hz	49 Hz	51 Hz

5. The currently measured voltage between the terminals U1/+ and U2/- appears on the display. In addition, you can query the system frequency  $f$  using the Up and Down key when AC voltage is applied.



For detailed information about the preset function and other voltage and frequency ranges refer to page 14.

page 40 provides a summary of all factory settings.



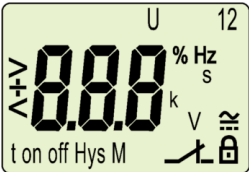

If you want to reset the voltage monitors to factory settings, refer to page 38.

## 5.2 Display elements in use

The meaning of the display elements in use is listed in detail in the table below.

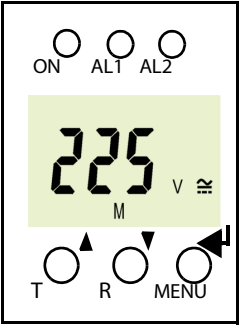
Display elements in use	Element	Function
	< U, > U	Undervoltage (Alarm 2), overvoltage (Alarm 1)
	R1, r1, R2, r2	Alarm relay K1, Alarm relay K2
	U Hys, %	Response value hysteresis U as %
	< Hz, > Hz	Underfrequency (AL1 and AL2) Overfrequency (AL1 and AL2)
	Hz Hys	Frequency response value hysteresis as Hz
	ton1, ton2, t, toff	Response delay $t_{on1}$ (K1), Response delay $t_{on2}$ (K2) Starting delay $t$ , Release delay $t_{off}$ for K1, K2
	M	Fault memory active
		Operating mode of the relays K1, K2; resp. LEDs AL1/AL2 indicate the alarm state of K1/K2
		Password protection active

### 5.3 Function of the operating elements

Device front	Element	Function
	ON	Power On LED, green
	AL1, AL2	<b>Menu item LED  deactivated:</b> LED Alarm 1 lights (yellow): Response value > U reached LED Alarm 2 lights (yellow): Res- ponse value < U reached
	AL1 and AL2	<b>Menu item LED  deactivated:</b> Both LEDs light when the frequency response values > Hz or < Hz are reached.
	AL1, AL2	<b>Menu item LED  activated:</b> LED Alarm 1 lights (yellow): K1 signals that there is an alarm LED Alarm 2 lights (yellow): K2 signals that there is an alarm
	225 V, M	Display in standard mode: $U_n = 225 \text{ V}$ ; Fault memory active
	T, ▲	Test button (> 1.5 s): Indication of the display elements, starting a self test; Up key (< 1.5 s): Menu items/values
	R, ▼	Reset button (> 1.5 s): Deleting the fault memory; Down key (< 1.5 s): Menu items/values



Device front	Element	Function
	MENU, 	MENU key (> 1.5 s): Starting the menu mode; Enter key (< 1.5 s): Confirm menu item, submenu item and value. Enter key (> 1.5 s): Back to the next higher menu level.

## 5.4 Menu structure

All adjustable parameters are listed in the columns menu item and adjustable parameters. A display-like representation is used to illustrate the parameters in the column menu item. Different alarm categories can be assigned to the alarm relays K1, K2 via the submenus r1, r2. This is done by activation or deactivation of the respective function.

Menu	Sub Menu	Menu item	Activation	Adjustable parameter
AL (response - values)		< U	ON	Undervoltage (Alarm 2)
		> U	ON	Overvoltage (Alarm 1)
		U Hys	-	Hysteresis < U / > U
		< Hz	OFF	Underfrequency
		> Hz	OFF	Overfrequency
		Hz Hys	-	Hysteresis, frequency



Menu	Sub Menu	Menu item	Activation	Adjustable parameter	
out (output control)	→	M	ON	Fault memory (on, con, off)	
		 1	-	Operating mode K1 (n.o.)	
		 2	-	Operating mode K2 (n.c.)	
		 LEd	OFF	LEDs signal relay in alarm state	
	r1 (K1: (assignment alarm category))	1 Err	OFF	Device error at K1	
		r1 < U	OFF	Undervoltage K1	
		r1 > U	ON	Overvoltage K1	
		r1 < Hz	ON	Underfrequency K1	
		r1 > Hz	ON	Overfrequency K1	
		1 S.AL	OFF	Start with alarm during $t + t_{on1}$	
	r2 (K2: (assignment alarm category))	2 Err	OFF	Device error K2	
		r2 < U	ON	Undervoltage K2	
		r2 > U	OFF	Overvoltage K2	
		r2 < Hz	ON	Underfrequency K2	
		r2 > Hz	ON	Overfrequency K2	
		2 S.AL	OFF	Start with alarm during $t + t_{on2}$	
	t (timing check)	→	ton1	-	Response delay K1
			ton2	-	Response delay K2
			t	-	Starting delay
toff			-	Delay on release K1/K2	

Menu	Sub Menu	Menu item	Activation	Adjustable parameter
Set (device control)	→		OFF	Parameter setting via password
		FAC	-	Re-establish factory settings
		PrE	-	Manual preset
		SYS	-	Function blocked
InF	→		-	Display hard / software version
HiS	→	Clr	-	History memory for the first alarm value, erasable

## 5.5 Display in standard mode

By default, the display indicates the voltage applied between the terminals U1/+ and U2/-. In order to change the default display, confirm your choice with Enter.



*In the standard mode, the currently measured voltage or frequency can be displayed using the Up and Down keys.*

## 5.6 Display in menu mode

### 5.6.1 Parameter query and setting: Overview

Menu item	Adjustable parameter
AL	Interrogate and adjust response values: <ul style="list-style-type: none"> <li>- Undervoltage: &lt; U (AL2)</li> <li>- Overvoltage: &gt; U (AL1)</li> <li>- Hysteresis of the voltage response values: Hys U</li> <li>- Underfrequency: &lt; Hz (AL1 and AL2)</li> <li>- Overfrequency: &gt; Hz (AL1 and AL2)</li> <li>- Hysteresis of the frequency response values: Hys Hz</li> </ul>
out	Configuration of the fault memory and the alarm relays: <ul style="list-style-type: none"> <li>- To activate/deactivate the fault memory or to set to con mode</li> <li>- Select N/O operation (n.o.) or N/C operation (n.c.) individually for each K1/K2</li> <li>- Assign the alarm categories undercurrent, overcurrent, underfrequency, overfrequency or device error individually to each K1/K2 (1, r1 / 2, r2).</li> <li>- AL1/AL2 indicate that K1/K2 are in alarm state (LEd)</li> </ul>
t	Delay setting: <ul style="list-style-type: none"> <li>- Response delay <math>t_{on1}/t_{on2}</math></li> <li>- Starting delay <math>t</math></li> <li>- Release delay <math>t_{off}</math> (LED, relay)</li> </ul>
Set	Parameter setting for device control: <ul style="list-style-type: none"> <li>- Enabling/disabling password protection, changing the password</li> <li>- Restoring factory settings;</li> <li>- Starting preset function PrE;</li> <li>- Service menu SyS blocked</li> </ul>
InF	Query hard and software version
HiS	Query the first stored alarm value
ESC	Move to the next higher menu level (back)

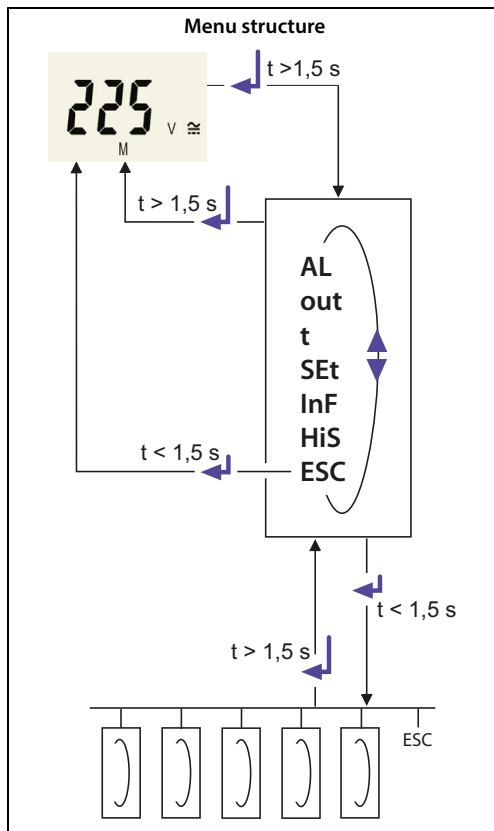

## Parameter settings

An example is given below on how to change the alarm response value for overvoltage  $> U$ . Proceed as follows:

1. Press the MENU/Enter key for more than 1.5 seconds. The flashing short symbol AL appears on the display.
2. Confirm with Enter. The parameter undervoltage  $< U$  is flashing.
3. Press the Down key to select the parameter overvoltage  $> U$ . The parameter  $> U$  flashes.
4. Confirm with Enter. A flashing "on" indicates that the response value  $> U$  is being activated.
5. Confirm the activation of the response value with Enter. The associated value in V appears on a flashing display.
6. Use the Up or Down key to set the appropriate response value. Confirm with Enter.  $> U$  flashes.
7. You can exit the menu by:
  - Pressing the Enter key for more than 1.5 seconds to reach the next higher level or
  - selecting the menu item ESC and confirming with Enter to reach the next higher level.



*The currently active segments are flashing! In the figures below, the segments where device settings can be carried out are highlighted by an oval.*

*The menu mode can be reached by pressing the MENU key for more than 1.5 seconds.*

## 5.6.2 Setting the response values for undervoltage, overvoltage and hysteresis

Set the response value at which an alarm is to be issued.

### Setting the undervoltage response value $< U$

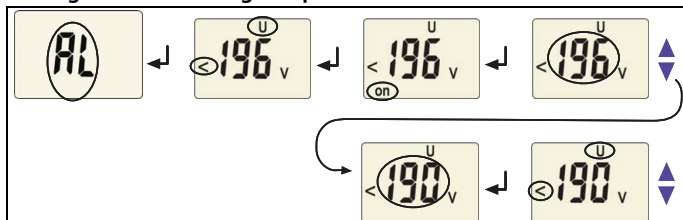

### Setting the overvoltage response value $> U$

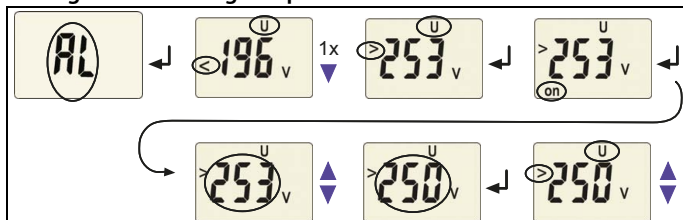

### Setting the hysteresis of the voltage response values

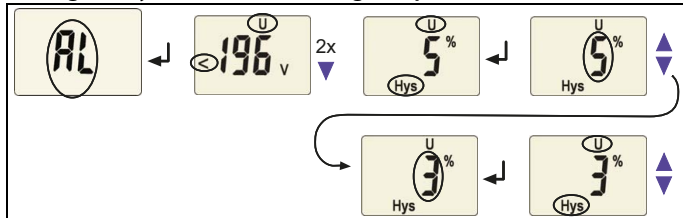

### 5.6.3 Setting the response values for underfrequency, overfrequency and hysteresis

#### Setting the underfrequency response value < Hz

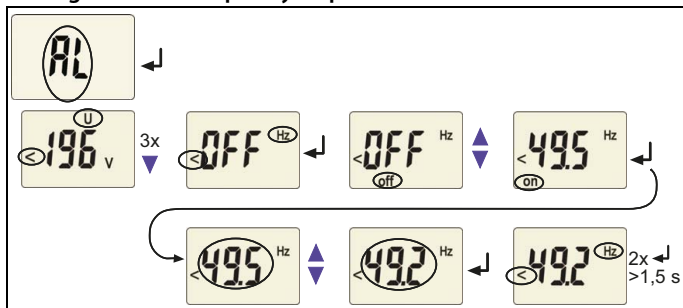

#### Setting the overfrequency response value > Hz

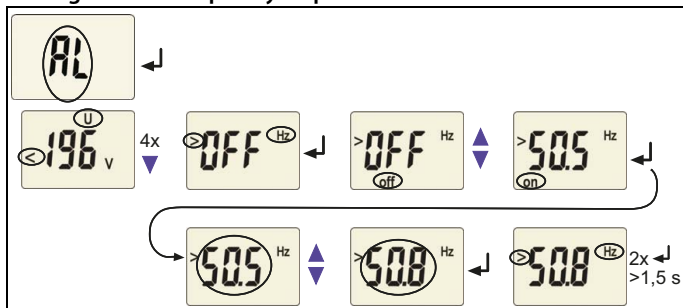

## Setting the hysteresis of the frequency response values

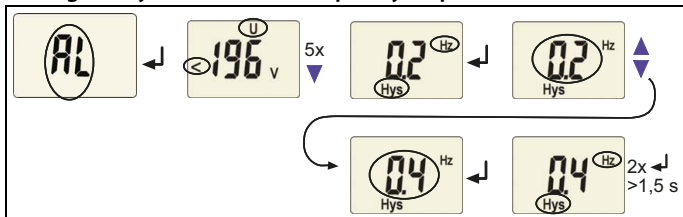

## 5.6.4 Setting the fault memory and operating principle of the alarm relays

### Deactivating the fault memory

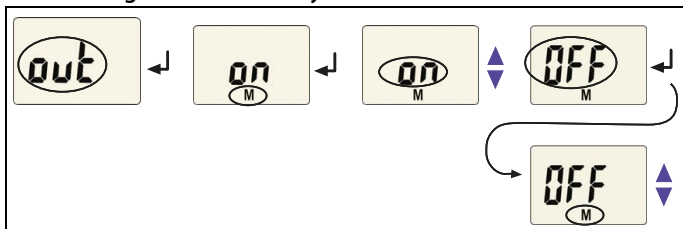

### Setting the alarm relay K1 to N/C operation (n.c.)

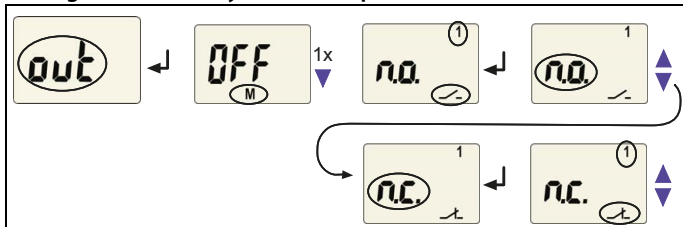



### Setting the alarm relay K2 to N/O operation (n.o.)

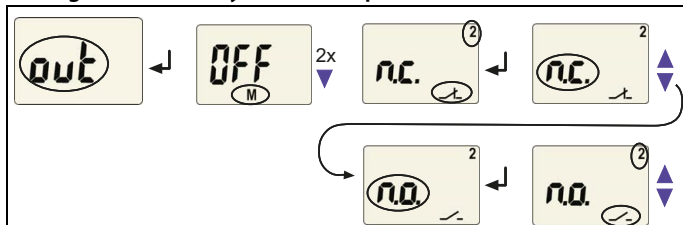

### LEDs AL1/AL2 are intended to indicate the alarm state of K1/K2

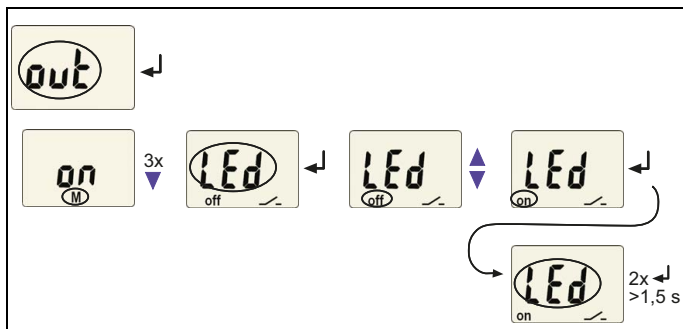

## 5.6.5 Assigning alarm categories to the alarm relays

Undervoltage, overvoltage, underfrequency, overfrequency and device-related error messages of the voltage relay can be assigned to the alarm relays K1 (r1, 1) and K2 (r2, 2). K1 is set at the factory to signal an alarm in the event of overvoltage, and K2 is set to signal an alarm in the event of undervoltage. A few assignment examples for alarm relay K1 are illustrated below:

### Alarm relay K1: Assigning the category device error

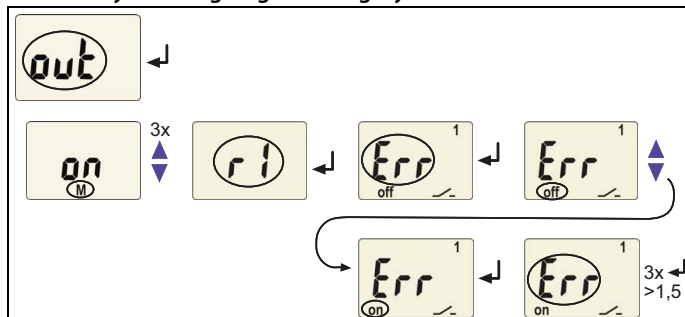

### Alarm relay K1: Assigning the category undervoltage

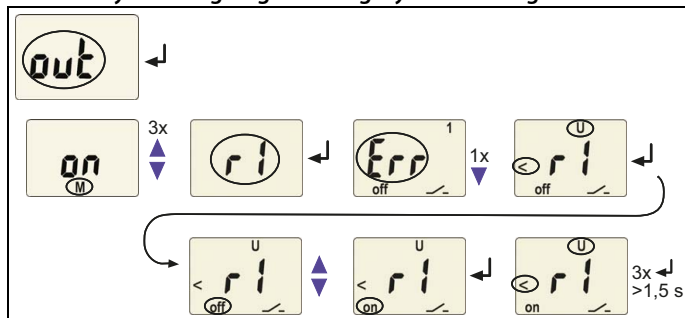

## Alarm relay 1: Deactivating the category overvoltage

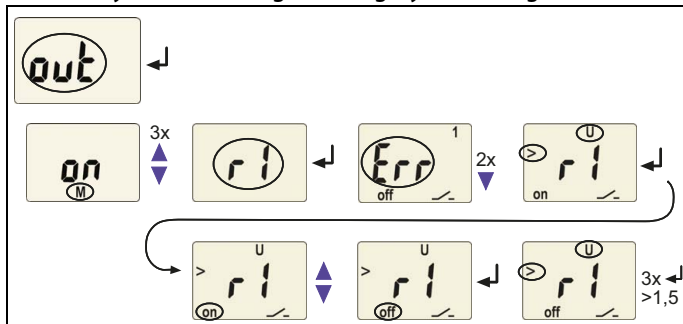

**CAUTION**

When an alarm relay (K1/K2) has been deactivated via the menu, an alarm will not be signalled by the respective changeover contact! An alarm will only be indicated by the respective alarm LED (AL1/AL2)!

*This only applies to the out menu setting LED = off!*

### 5.6.6 Setting the time delay

Use this segment to set a response delay  $t_{on1}$  (0...300 s) for K1,  $t_{on2}$  (0...300 s) for K2, a start-up delay  $t$  (0...300 s) when starting the device, as well as a common release delay  $t_{off}$  (0...300 s) for K1, K2. This setting is only relevant when the fault memory M is deactivated.

The operating steps for the setting of the response delay  $t_{on1}$  and the starting delay  $t$  are illustrated by way of example.

#### Setting the response delay $t_{on1}$

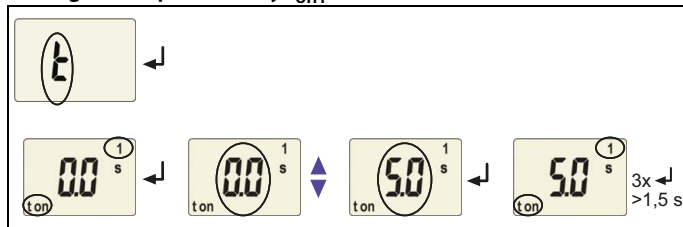

#### Setting the starting delay $t$

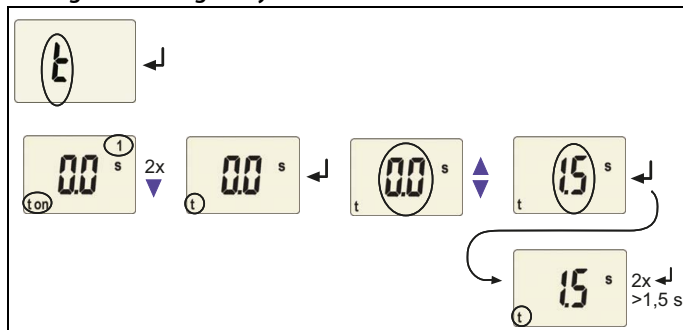

### 5.6.7 Factory setting and password protection

Use this menu to activate the password protection, to change the password or to deactivate the password protection. In addition, you can reset the device to its factory settings.

#### a) Activating the password protection

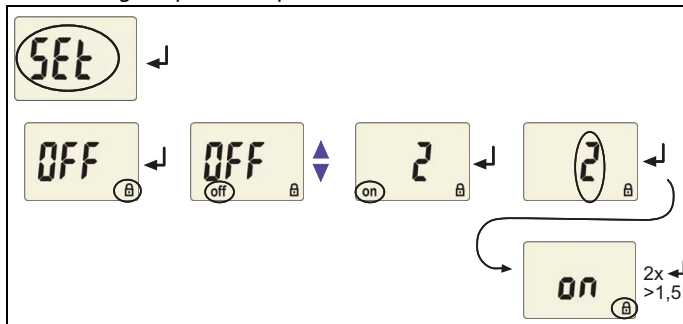

#### b) Changing the password

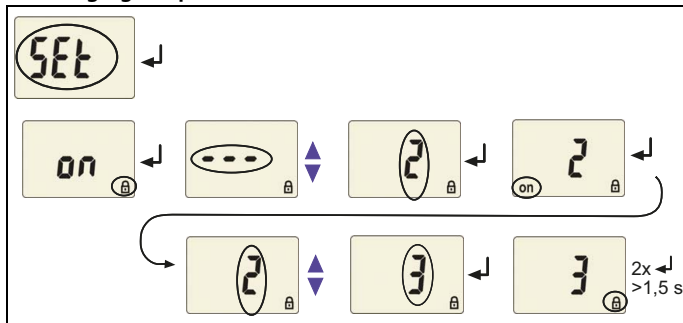

### c) Deactivating the password protection

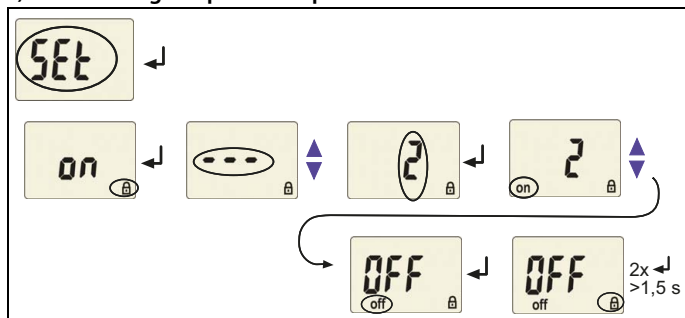

### 5.6.8 Restoring factory settings

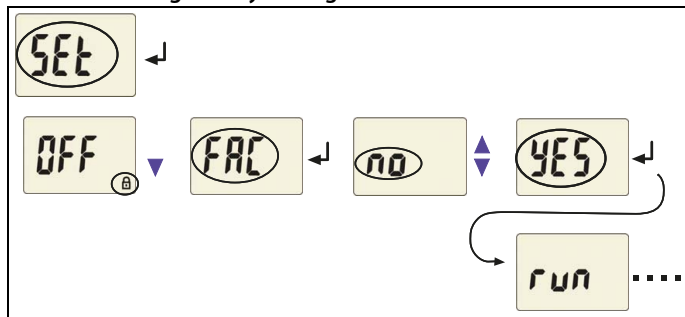

### 5.6.9 Manual activation of the preset function

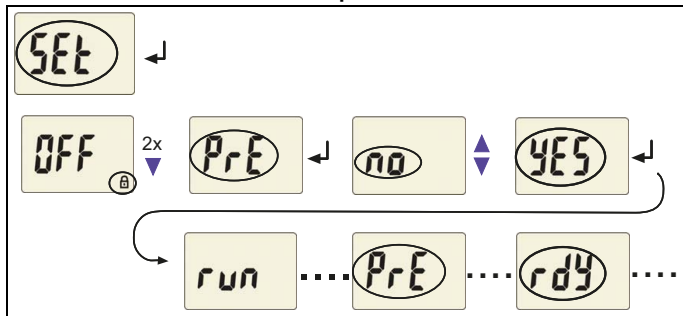

### 5.6.10 Device information query

This function is used to query the hardware (d...) and software (1.xx) versions. After activating this function, data will be displayed as a scrolling text. Once one pass is completed, you can select individual data sections using the Up/Down keys.

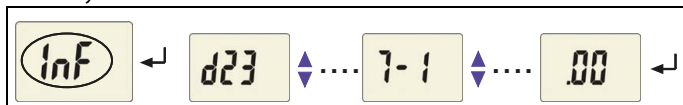

### 5.6.11 History memory query

The history memory can be selected via the menu HiS. Use the Up and Down keys to view the next display. If Clr is flashing, the history memory can be cleared by pressing the Enter key.

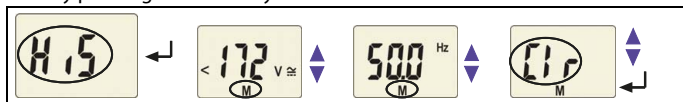

## 5.7 Preset function/ factory setting

During the first start-up process the following response values are automatically set related to  $U_n$ :

Response value: overvoltage ( $> U$ ):  $1.1 U_n$

Response value: undervoltage ( $< U$ ):  $0.85 U_n$



<i>Hysteresis U:</i>	5 %
<i>Underfrequency &lt; Hz</i>	OFF
<i>Overfrequency &gt; Hz</i>	OFF
<i>Hysteresis frequency (Hys Hz):</i>	0.2 Hz
<i>Fault memory M:</i>	on
<i>Operating principle K1 (&gt; U):</i>	N/O operation (n.o.)
<i>Operating principle K2 (&lt; U):</i>	N/C operation (n.c.)
<i>AL1/AL2 indicate the alarm state of K1/K2 (LEd):</i>	OFF
<i>Alarm to an K1/K2 (S.AL) when the device is started:</i>	OFF
<i>Start-up delay:</i>	$t = 0 \text{ s}$
<i>Response delay:</i>	$t_{on1} = 0 \text{ s}$ $t_{on2} = 0 \text{ s}$
<i>Release delay:</i>	$t_{off} = 0.5 \text{ s}$
<i>Password:</i>	0, Off

## 5.8 Commissioning

Prior to commissioning, check proper connection of the voltage monitor.



After connecting a brand-new VME421H-D-2 to a standard system of  $U_n = 230 \text{ V } 50 \text{ Hz}$ , the response values are automatically set by the internal preset function:  
 Overvoltage = 253 V (230 V + 10 %) (50 Hz + 1 Hz)  
 Undervoltage = 196 V (230 V - 15 %) (50 Hz - 1 Hz)  
 Other operating ranges of the preset function are given in the technical data "response values" and in the description of the function.



## 6. Technical data VME421H...

( ) \* = factory setting

\*\*Technical data are only guaranteed within the operating range of the rated frequency (15...460 Hz).

### Insulation coordination acc. to IEC 60664-1/IEC 60664-3

Rated insulation voltage .....	250 V
Rated impulse voltage/overvoltage category.....	4 kV / III
Pollution degree.....	3
Protective separation (reinforced insulation) between:	
.....	(U1/+ , U2/-) - (11-12-14) - (21-22-24)
Voltage test acc. to IEC 61010-1 .....	2.21 kV

### Supply voltage

VME421H-D-1:

Supply voltage  $U_S$  ..... none (internally supplied by  $U_n$ : 9,6...150 V)

VME421H-D-2:

Supply voltage  $U_S$  ..... none (internally supplied by  $U_n$ : 70...300 V)

Power consumption .....

≤ 6 VA

### Measuring circuit

Measuring range (r.m.s.) (VME421H-D-1) .....

AC / DC 0...150 V

Measuring range (r.m.s.) (VME421H-D-2) .....

AC / DC 0...300 V

Rated frequency  $f_n$  .....

DC, 15...460 Hz

Frequency range .....

10...500 Hz\*\*

### Response values

VME421H-D-1:

Undervoltage < U (Alarm 2) .....

AC / DC 9.6...150 V

Overvoltage > U (Alarm 1) .....

AC / DC 9.6...150 V

Preset function:

Undervoltage < U (0.85  $U_n$ )\* for  $U_n = 120$  V / 60 V / 24 V .....

102 V / 51 V / 20.4 V

Overvoltage > U (1.1  $U_n$ )\* for  $U_n = 120$  V / 60 V / 24 V .....

132 V / 66 V / 26.4 V

Resolution of setting U 9.6...49.9 V .....

0.1 V

Resolution of setting U 50...150 V .....	1 V
VME421H-D-2:	
Undervoltage < U (Alarm 2) .....	AC / DC 70...300 V
Overvoltage > U (Alarm 1) .....	AC / DC 70...300 V
Resolution of setting U 70...300 V .....	1 V
Preset function:	
Undervoltage < U (0.85 $U_n$ )* for $U_n = 230\text{ V} / 120\text{ V}$ .....	196 V / 102 V
Overvoltage > U (1.1 $U_n$ )* for $U_n = 230\text{ V} / 120\text{ V}$ .....	253 V / 132 V
VME421H...:	
Relative uncertainty voltage at 50/60 Hz .....	$\pm 1.5\%$ , $\pm 2$ digits
Relative uncertainty voltage in the range of 15...460 Hz .....	$\pm 3\%$ , $\pm 2$ digits
Hysteresis U .....	1...40% (5%)*
Underfrequency < Hz .....	10...500 Hz**
Overfrequency > Hz .....	10...500 Hz**
Resolution of setting f 10.0...99.9 Hz .....	0.1 Hz
Resolution of setting f 100...500 Hz .....	1 Hz
Preset function:	
Underfrequency for $f_n = 16.7\text{ Hz} / 50\text{ Hz} / 60\text{ Hz} / 400\text{ Hz}$ .....	15.7 Hz / 49 Hz / 59 Hz / 399 Hz
Overfrequency for $f_n = 16.7\text{ Hz} / 50\text{ Hz} / 60\text{ Hz} / 400\text{ Hz}$ .....	17.7 Hz / 51 Hz / 61 Hz / 401 Hz
Hysteresis frequency Hys Hz .....	0.1...2 Hz (0.2 Hz)*
Relative uncertainty frequency in the range of 15...460 Hz .....	$\pm 0.2\%$ , $\pm 1$ digit

## Specified time

Start-up delay .....	0...300 s (0 s)*
Response delay $t_{on1/2}$ .....	0...300 s (0 s)*
Release delay $t_{off}$ .....	0...300 s (0.5 s)*
Resolution of setting $t, t_{on1/2}, t_{off}$ (0...10 s) .....	0.1 s
Resolution of setting $t, t_{on1/2}, t_{off}$ (10...99 s) .....	1 s
Resolution of setting $t, t_{on1/2}, t_{off}$ (100...300 s) .....	10 s
Operating time voltage $t_{ae}$ .....	DC/AC 16.7 Hz: $\leq 130\text{ ms}$ , AC 42...460 Hz: $\leq 70\text{ ms}$
Operating time, frequency $t_{ae}$ .....	AC 15...460 Hz: $\leq 310\text{ ms}$
Response time $t_{an}$ .....	$t_{an} = t_{ae} + t_{on1/2}$
Discharging time energy backup on power failure (VME421H-D-1) .....	$\geq 3\text{ s}$
Discharging time energy backup on power failure (VME421H-D-1) .....	$\geq 2.5\text{ s}$ at $f_n < 42\text{ Hz}$
Discharging time energy backup on power failure (VME421H-D-2) .....	$\geq 4\text{ s}$ at DC 70 V

.....	≥ 6 s at DC 80 V / AC 70 V
Charging time energy backup (VME421H-D-1) .....	≤ 60 s
Charging time energy backup (VME421H-D-2) .....	≤ 120 s
Recovery time $t_b$ .....	≤ 300 ms

## Displays, memory

Display .....	LC display, multi-functional, not illuminated
Display range, measuring value (VME421H-D-1) .....	AC/DC 0 ... 150 V
Display range, measuring value (VME421H-D-2) .....	AC/DC 0 ... 300 V
Operating uncertainty at 50/60 Hz .....	±1.5 %, ±2 digits
Operating uncertainty voltage in the range of 15 ... 460 Hz .....	±3 %, ±2 digits
Operating uncertainty in the frequency range 15 ... 460 Hz .....	±0.2 %, ±1 digit
History memory (HiS) for the first alarm value .....	data record measured values
Password .....	Off / 0 ... 999 (OFF)*
Fault memory (M) alarm relay .....	on / off / con (on)*

## Switching elements

Number of changeover contacts .....	2 x 1 (K1, K2)
Operating principle .....	N/C operation / N/O operation
.....	K2: Err, < U, > U, < Hz, > Hz, S.AL (undervoltage < U: N/C operation n.c.)*
.....	K1: Err, < U, > U, < Hz, > Hz, S.AL (overvoltage > U: N/O operation n.c.)*
Electrical service life under rated operating conditions .....	10000 switching operations
Contact data acc. to IEC 60947-5-1:	
Utilization category .....	AC 13..... AC 14..... DC-12..... DC-12..... DC-12
Rated operational voltage .....	230 V..... 230 V..... 24 V..... 110 V..... 220 V
Rated operational current.....	5 A..... 3 A..... 1 A..... 0.2 A..... 0.1 A
Minimum contact rating .....	1 mA at AC/DC ≥ 10 V

## Environment/EMC

EMC .....	IEC 61326
Operating temperature .....	-25 °C ... +55 °C
Classification of climatic conditions acc. to IEC 60721:	
Stationary use (IEC 60721-3-3) .....	3K5 (except condensation and formation of ice)
Transportation (IEC 60721-3-2) .....	2K3 (except condensation and formation of ice)
Storage (IEC 60721-3-1) .....	1K4 (except condensation and formation of ice)

Classification of mechanical conditions acc. to IEC 60721:

Stationary use (IEC 60721-3-3) .....	3M4
Transportation (IEC 60721-3-2) .....	2M2
Storage (IEC 60721-3-1) .....	1M3

## Connection

 Connection ..... **screw-type terminals**

Connection properties:

rigid/ flexible .....	0.2...4 / 0.2...2.5 mm <sup>2</sup> / AWG 24...12
-----------------------	---------------------------------------------------

Multi-conductor connection (2 conductors with the same cross section):

rigid/ flexible .....	0.2...1.5 mm <sup>2</sup> / 0.2...1.5 mm <sup>2</sup>
-----------------------	-------------------------------------------------------

Stripping length .....	8...9 mm
------------------------	----------

Tightening torque .....	0.5...0.6 Nm
-------------------------	--------------

 Connection type ..... **push-wire terminals**

Connection properties:

rigid .....	0.2...2.5 mm <sup>2</sup> ( AWG 24...14)
-------------	------------------------------------------

Flexible without ferrules .....	0.75...2.5 mm <sup>2</sup> ( AWG 19...14)
---------------------------------	-------------------------------------------

Flexible with ferrules.....	0.2...1.5 mm <sup>2</sup> ( AWG 24...16)
-----------------------------	------------------------------------------

Stripping length .....	10 mm
------------------------	-------

Opening force.....	50 N
--------------------	------

Test opening, diameter.....	2.1 mm
-----------------------------	--------

## Other

Operating mode .....	continuous operation
----------------------	----------------------

Position .....	any position
----------------	--------------

Degree of protection DIN EN 60529, internal components .....	IP30
--------------------------------------------------------------	------

Degree of protection DIN EN 60529, terminals.....	IP20
---------------------------------------------------	------

Enclosure material .....	polycarbonate
--------------------------	---------------

Flammability class .....	UL94 V-0
--------------------------	----------

DIN rail mounting acc. to.....	IEC 60715
--------------------------------	-----------

Screw fixing .....	2 x M4 with mounting clip
--------------------	---------------------------

Software version VME421H-D-1 .....	D236 V2.2x
------------------------------------	------------

Software version VME421H-D-2 .....	D237 V2.2x
------------------------------------	------------

Weight .....	≤ 240 g
--------------	---------

( ) \* = factory setting

\*\*Technical data are only guaranteed within the operating range of the rated frequency (15...460 Hz).

## 6.1 Ordering information

Device type	Nominal system voltage $U_n^*$	Art. No.
VME421H-D-1 (push-wire terminals)	AC/DC 9.6...150 V 15...460 Hz	B 7301 0003
VME421H-D-1	AC/DC 9.6...150 V 15...460 Hz	B 9301 0003
VME421H-D-2 (push-wire terminals)	AC/DC 70...300 V 15...460 Hz	B 7301 0004
VME421H-D-2	AC/DC 70...300 V 15...460 Hz	B 9301 0004
*Absolute values of the voltage range		
Mounting clip for screw fixing (1 piece per device, accessories)		B 9806 0008

## 6.2 Standards, approvals and certifications





# INDEX

## A

Adjustable parameters, list 24, 25, 26

Automatic self test 15

## C

currently measured values

- nominal voltage 26

- rated frequency 26

## D

Deleting the fault alarms 23

Device features 13

Discharging time energy backup on power failure 42

Display elements in use 22

Display in menu mode 27

Display in standard mode 26

## E

Enter key 24

Example of parameter setting 29

## F

factory 40

factory setting 17, 40

Fast commissioning for  $U_n = 230\text{ V}$  12

Fault memory in the operating mode on, off or con 13, 15

Function 13

## H

How to use this manual 5

## I

Indication of the alarm state of K1/K2 17

Installation 19

Intended use 12

## K

K1: assignment alarm category 25

K2: assignment alarm category 25

## L

LED Alarm 1 lights 23

LED Alarm 2 lights 23

## M

Malfunction 15

Manual self test 15

Menu

- AL (response values) 24

- HiS (history memory for the first alarm value) 26

- InF (hard and software version) 26

- out (output control) 25

- Set (device control) 26

- t (timing check) 25

Menu item LED 17

Menu structure 24

Mounting clip for screw fixing 45

## O

Operating elements, function 23

Operation and setting 21

Ordering information 45

## P

Parameter query and setting

- 27

Parameter setting

- Activating or deactivating the password protection 37

- Assigning alarm categories to the alarm relays 34

- Deactivating the fault memory 32

- Response value setting 30

- Setting the operating principle of the alarm relays 32

- Setting the time delay 36

Password protection 16

Preset function 14

## R

Release delay toff 16

Reset button 23

Response delay ton 16, 36

Response value setting

- Hysteresis frequency 32

- Hysteresis U 30

- Overfrequency (> Hz) 31

- Overvoltage (> U) 30

- Underfrequency (< Hz) 31

- Undervoltage (< U) 30

## S

Service 6

Simulated alarm 18

Starting a device using a simulated alarm

S.AL 18

Starting delay t 16, 36

Starting the menu mode 24

Support 6

## T

Technical data 41

Test button 23

Time delays 14, 16

Training courses 8

## W

Wiring diagram 20

Work activities on electrical installations 11  
workshops 8









# optec

energie ist messbar

Optec AG | Guyer-Zeller-Strasse 14 | CH-8620 Wetzikon ZH

Telefon: +41 44 933 07 70 | Telefax: +41 44 933 07 77

E-Mail: [info@optec.ch](mailto:info@optec.ch) | Internet: [www.optec.ch](http://www.optec.ch)



## **Bender GmbH & Co. KG**

P.O. Box 1161 • 35301 Gruenberg • Germany

Londorfer Strasse 65 • 35305 Gruenberg • Germany

Tel.: +49 6401 807-0 • Fax: +49 6401 807-259

E-Mail: [info@bender.de](mailto:info@bender.de) • [www.bender.de](http://www.bender.de)



Photos: Bender archives

**BENDER Group**