



Power factor correction (PFC) and harmonics filter

optec

energie ist messbar

Optec AG | Guyer-Zeller-Strasse 14 | CH-8620 Wetzikon ZH

Telefon: +41 44 933 07 70 | Telefax: +41 44 933 07 77

E-Mail: info@optec.ch | Internet: www.optec.ch

Types of power factor correction (PFC)

Individual PFC

- A suitably sized capacitor will be connected in parallel to each inductive load
- Relieving of the load on the supply line as well as the switching equipment
- No separate switching equipment required for the capacitor and no controller required
- Economic with longer duty cycles and greater power draw

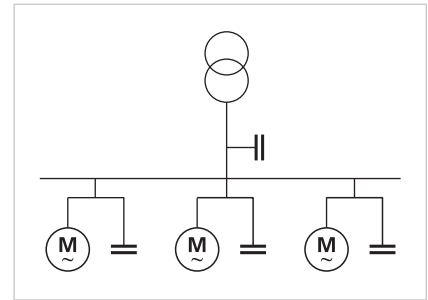

Group PFC

- Will be implemented with load groups with the same operational behaviour
- For multiple inductive loads, that are always operated together
- The supply lines and group switches will be relieved of reactive current and the simultaneity factor results in a smaller capacitor size

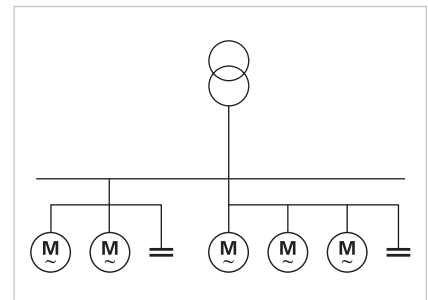

Automatic central PFC (APFC)

- The central PFC will be integrated into the main LV distribution
- Near constant, good power factor that adapts automatically through a power factor controller via contactors or thyristor switches
- The output of the capacitors installed will be better utilised
- Better adaptation of the capacitor power to the reactive power demand
- Networks with harmonics can be more easily detuned through APFC

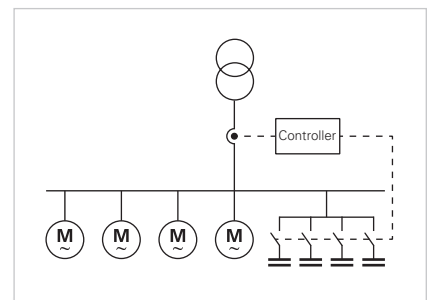

Mixed PFC

- Combination of individual, group and central PFC

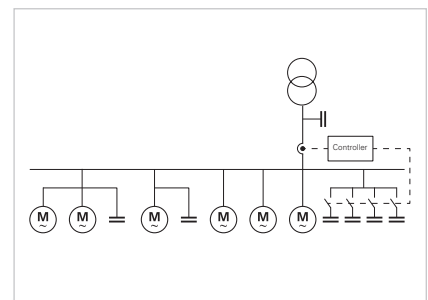

Hybrid switching



Harmonics display



Dynamic PFC



Smart control



Prophi® power factor controller

Interfaces / communication (optional)

- RS485
- Profibus

Communication / protocols (optional)

- Modbus RTU (up to 115.2 kBit/s)
- Profibus DP V0 (1.5 MBit/s)

Triple Safety

- Temperature monitoring
- Monitoring the capacitor switching cycles
- Monitoring of over-current

Power quality

- Harmonics up to the 19th
- THD-U in %
- THD-I in %

Smart control

- Minimised number of switching cycles
- Balanced number of contactor switching cycles
- Optimised service life

Network visualisation software

- GridVis®-Basic (in the scope of supply)

Alarm messages

- Under-voltage detection
- Over-voltage detection
- Under-compensation
- Measurement current exceedance
- Harmonics threshold values
- Delivery of active power
- Overtemperature
- Dropping below the minimum measurement current

Switching outputs (depending on variants)

- 6 conventional relay outputs
- 12 conventional relay outputs
- 6 transistor outputs for dynamic PFC
- 12 transistor outputs for dynamic PFC
- 6 transistor and 6 relay outputs for hybrid PFC

Areas of application



- Automatically controlled power factor correction
- Detuned power factor correction
- Harmonics filter
- Voltage stabilisation by means of dynamic PFC
- Mixed operation (hybrid switching) contactors and thyristor switching

Main features

- Automatic or manual configuration
- Display of U, I, f, Q, P, S, cosphi, all odd current and voltage harmonics, 1 – 19th harmonics
- Display of the indirectly measured capacitor currents
- Display of the switching cycles per capacitor stage
- Display of the total switch-on duration per capacitor stage
- Zero voltage triggering within 15 ms
- Degree of reactors in % for each stage, programmable from 0 to 20 %
- Setting of the discharge time for all stages from 0 to 1200 sec.
- Capacitor outputs individually programmable
- Temperature sensor for fan control
- Overtemperature shut-down programmable
- Control of external semi-conductor switching (max. 50 switching operations per second)
- Current transformer input for 1 A; 5 A
- Password protection
- External, changable target cosphi 1 and 2 (except 6R / 6T)

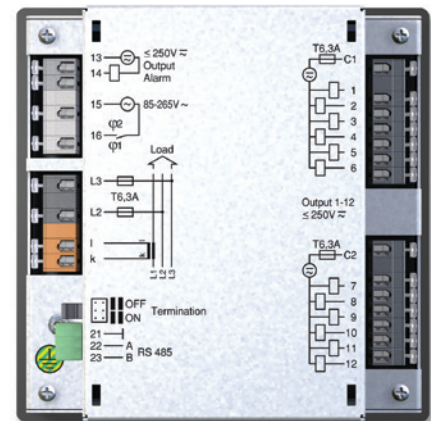

Fig.: Device rear side Prophi® 12RS

Alarm output programmable for ...

- Under-voltage detection
- Over-voltage detection
- Under-compensation
- Measurement current exceedance
- Dropping below the minimum measurement current
- Harmonics threshold values
- Delivery of active power
- Overtemperature

Functional principle

- Single-phase, electronic measurement system
- Acquisition of the active and reactive current portion of the network via the current and voltage circuit
- Reactive power will be calculated with the current from a phase conductor and the voltage between two phase conductors

- Switching ON or OFF of capacitor stages in the event of deviations in the set power factor
- Switching of capacitors via contactors or semiconductors
- Control via capacitor contactors is implemented in an optimised manner
- Transistor outputs for the near-realtime control of semiconductor switches



Fig.: Display examples: Voltage

Fan control

- Fan control via integrated temperature sensors
- Either via relay outputs or the alarm relay
- Programming of a lower or upper limit temperature necessary



Fig.: Reactive power

Automatic configuration

- With the "LEARN" function it is possible to learn and save the connection configuration of the power factor controller

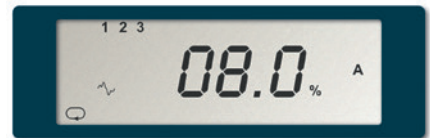

Fig.: Harmonics

LCD display

- High quality LCD display with excellent contrast
- Display of comprehensive measurement parameters (app. 100 measured values)

Overtemperature shut-down

- The overtemperature shut-down switches off connected capacitor stages
- This results in the reduction of the interior temperature of the PFC cabinet and protects the capacitors
- Programming of a lower or upper limit temperature as well as the pause time

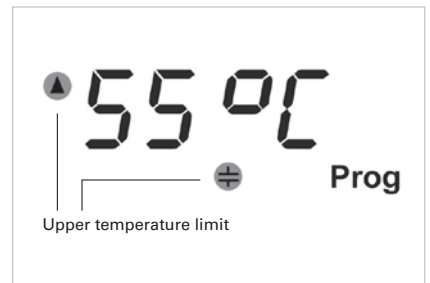

Fig.: Overtemperature shut-down

Interface

- Depending on version, equipped with an RS485 interface
- The Modbus RTU or Profibus DP V0 protocols are available via RS485
- Integration of PLC systems, building management systems or energy management systems
- Modbus transfer rates: 9.6; 19.2; 38.4; 57.6; 115.2 kBit/s
- Profibus transfer rates: Up to max. 1.5 Mbit/s

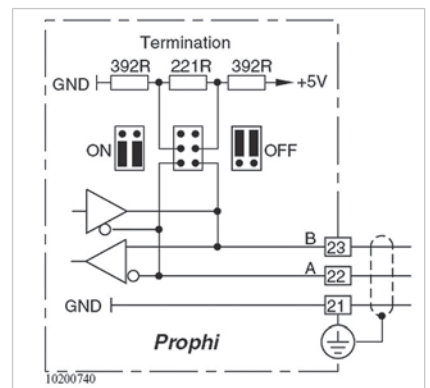
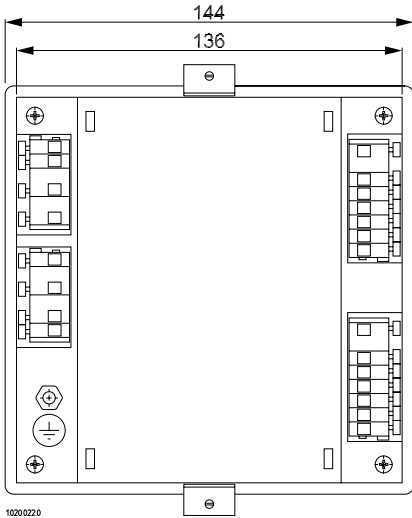

Fig.: Connection assignment - RS485 interface



Dimension diagrams

All dimensions in mm



10200220

Rear side view

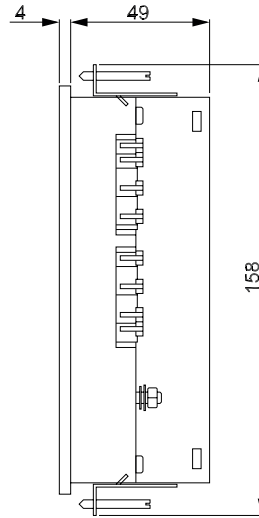

Side view

Cut out: 138^{+0.8} x 138^{+0.8} mm



Typical connection

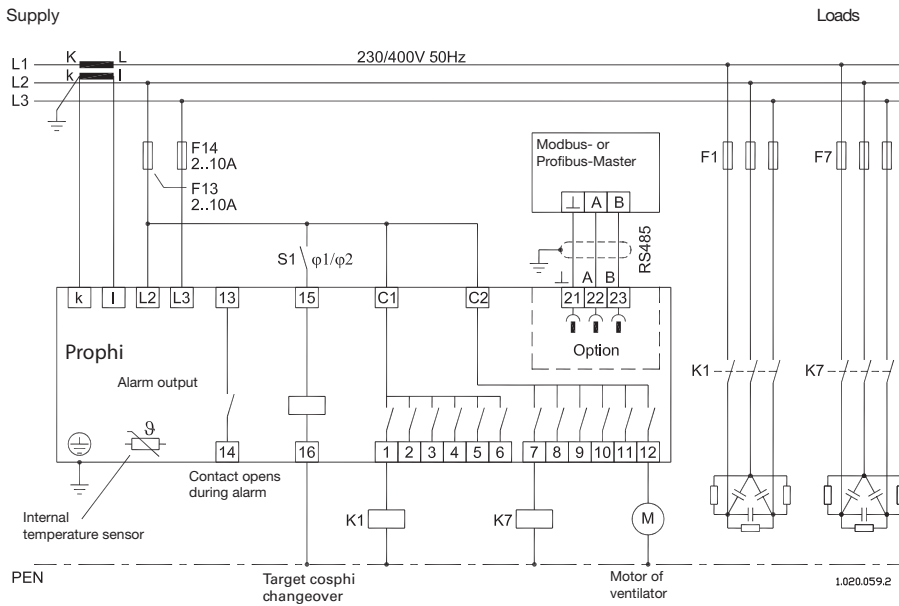

Fig.: Connection example power factor controller Prophi® 12RS (item no. 52.08.008) with voltage measurement L2–L3, 12 relay outputs, target cos(phi) changeover, alarm output and RS485 interface



Device overview and technical data

	Prophi® 6R	Prophi® 12R	Prophi® 6T	Prophi® 12T
Item number	52.08.002	52.08.003	52.08.005	52.08.006
Measurement and auxiliary voltage 400 V AC (+10 %, -15 %)*1	•	•	•	•
Changeover target cosphi 1/2	-	•	-	•
Outputs				
Relay outputs (conventional)	6	12	-	-
Transistor outputs (dynamic)	-	-	6	12
Interface Modbus or Profibus				
RS485 *2, *4	-	-	-	-
	Prophi® 6T6R	Prophi® 12RS	Prophi® 6T6RS	Prophi® 12TS
Item number	52.08.007	52.08.008	52.08.009	52.08.091
Measurement and auxiliary voltage 400 V AC (+10 %, -15 %)*1	•	•	•	•
Changeover target cosphi 1/2	•	•	•	•
Outputs				
Relay outputs (conventional)	6	12	6	-
Transistor outputs (dynamic)	6	-	6	12
Interface Modbus or Profibus				
RS485 *2, *4	-	•	•	•
Software				
GridVis®-Basic (included in the scope of supply)	-	• *3	• *3	• *3

*1 Optional measurement and auxiliary voltage 100 V, 110 V, 200 V, 230 V, 440 V AC (+10 %, -15 %).

*2 Not possible with 50 switching operations per second.

*3 Optional additional functions with the packages GridVis®-Professional, GridVis®-Enterprise and GridVis®-Service.

*4 Modbus or Profibus possible, please stipulate when ordering.

General	Prophi®
Use in low and medium voltage networks L-N or L-L	•
Accuracy voltage measurement (1-phase, L-N or L-L)	0.5 %
Accuracy current measurement (1-phase)	0.5 %
Accuracy cosphi measurement (sum L1-L3)	1 % *5,*6
Accuracy power measurement (sum L1-L3)	1 %
Accuracy frequency measurement	0,5 % *6
Accuracy harmonics measurement	2 %
RMS – momentary value	
Current, voltage, frequency	•
Effective, reactive and apparent power	•
Power factor	•
Recording of the mean values	
Power factor	•
Power quality measurement	
Harmonics per order / current and voltage, 1-phase	1st – 19th, odd
Distortion factor THD-U in %, 1-phase	•
Distortion factor THD-I in %, 1-phase	•
Measured data recording	
Mean, minimum, maximum values	•
Displays and inputs / outputs	
Digital display, 3 buttons	•
Relay outputs (as switch output)	6 or 12 See overview of devices
Transistor outputs (as switch output)	6 or 12 See overview of devices
Alarm output (as switch output)	1
Digital input (for tariff changeover)	1 See overview of devices
Temperature sensor (internal)	1

*5 Applies to input currents > 0.2 A and in the cosphi range 0.85 to 1.00.

*6 In the range from -10 to +18 °C and 28 to 55 °C an additional error of ±0,2 % of the measurement value per K must be taken into account.

Communication	
Interface	
RS485: 9.6; 19.2; 38.4; 57.6; 115.2 kbps	See overview of devices
Profibus DP V0: 9.6 kbps to 1.5 Mbps	See overview of devices
Protocols	
Modbus RTU	•
Profibus DP V0	•
Software GridVis®-Basic* ³	
Online graphs	•
Historical graphs	•
Databases (Janitza DB, Derby DB); MySQL, MS SQL with higher GridVis® versions)	•
Manual reports	•
Topology views	•
Manual reading	•
Graph sets	•
Error messages	
Under-voltage	•
Over-voltage	•
Dropping below the minimum measurement current	•
Measurement current exceedance	•
Insufficient compensation power	•
Delivery of active power	•
Harmonics threshold values	•
Overtemperature	•
Technical data	
Supply voltage L-L, L-N AC	See overview of devices
Measurement in which quadrants	4
Networks	TN, TT, (IT)
Measurement in multi-phase networks	3 ph
Measured voltage input	
Overvoltage category	CAT III
Measured range, voltage L-N, AC (without potential transformer)	See overview of devices
Measured range, voltage L-L, AC (without potential transformer)	See overview of devices
Voltage tolerance range	- 15 ... +10 %
Back-up fuse	2 A ... 10 AT
Measurement surge voltage	4 kV
Test voltage relative to ground	2,200 V AC
Frequency measuring range	45 ... 65 Hz
Power consumption	max. 7 VA
Sampling rate	2 kHz (at 50 Hz)
Measured current input	
Signal frequency	45 Hz ... 1,200 Hz
Nominal current at .../5 A (.../1 A)	5 A (1 A)
Minimum measurement current	10 mA
Upper measurement current	5.3 A (sinusoidal)
Overloading	180 A for 2 sec.
Measurement rate	30 (50) measurements / sec.
Power consumption	approx. 0.2 VA
Updating the display	1 time per second
Zero voltage triggering	< 15 ms
Inputs and outputs	
Number of digital inputs (for tariff changeover)	1, see overview of devices
Relay outputs (as switch output)	6 or 12, see overview of devices
Back-up fuse	6.3 AT
Switching voltage	max. 250 V AC
Switching power	max. 1,000 W

*³ Optional additional functions with the packages GridVis®-Professional, GridVis®-Enterprise and GridVis®-Service.

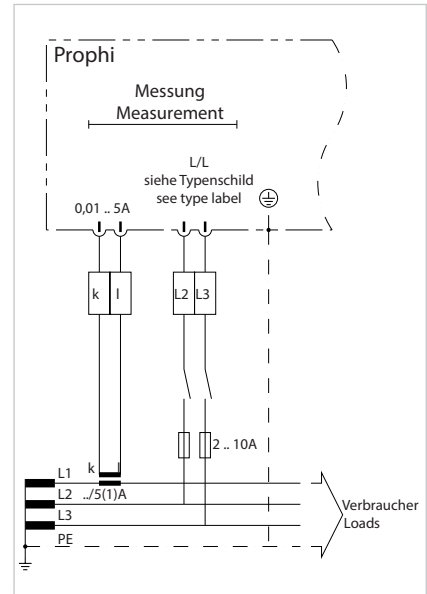

Fig.: Connection of measurement and auxiliary voltage between L2-L3 and the current measurement via current transformer

Max. switching frequency	50 Hz
Mechanical service life	> 30 x 10 ⁶ switching cycles
Electrical service life	> 2.8 x 10 ⁵ switching cycles
Transistor outputs (as switch output)	6 or 12, see overview of devices
Switching voltage	5 ... 30 V DC
Switching current	max. 50 mA
Max. switching frequency	50 Hz
Alarm output (as switch output)	1
Temperature sensor (internal)	1
Target cosphi changeover (current consumption)	approx. 2.5 ... 10 mA
Mechanical properties	
Weight	1000 g
Device dimensions in mm (H x W x D)	144 x 144 x 49
Protection class per IEC 60529	Front: IP65, Rear: IP20
Installation	Front panel installation
Connecting phase (U / I), Single core, multi-core, fine-stranded Terminal pins, core end sheath	0.08 to 2.5 mm ² 1.5 mm ²
Features	
Display of capacitor currents	•
Display of switch-on times for the individual stages	•
Display of switching cycles per stage	•
Zero voltage triggering	•
Automatic configuration	•
Password protection	•
Environmental conditions	
Temperature range	Operation: -10 ... +55 °C *7 Storage: -20 ... +60 °C
Relative humidity	15 to 95 %
Operating altitude	0 ... 2,000 m above sea level
Degree of pollution	2
Mounting position	any
Electromagnetic compatibility	
Electromagnetic compatibility of equipment	Directive 2004/108/EC
Electrical appliances for application within particular voltage limits	Directive 2006/95/EC
Equipment safety	
Safety requirements for electrical equipment for measurement, regulation, control and laboratory use – Part 1: General requirements	IEC/EN 61010-1
Part 2 – 008: Particular requirements for testing and measuring circuits	IEC/EN 61010-1-08
Protection class	I = Device with protective conductor
Noise immunity	
Industrial environment	DIN EN 61326-1, Table 2; (IEC 61326-1)
Emissions	
Class B: Residential environment	DIN EN 61326-1; (IEC 61326-1)
Class A: Industrial environment	DIN EN 61326-1; (IEC 61326-1)
Safety	
Europe	CE labelling

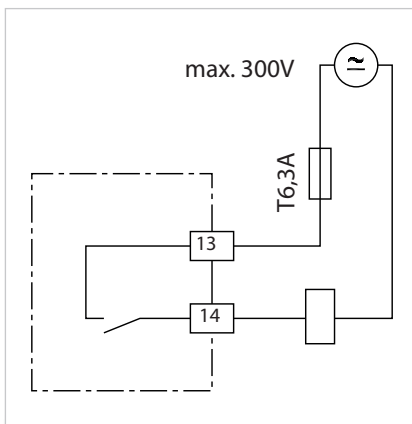

Fig.: Connection assignment, alarm output

Comment: For detailed technical information please refer to the operation manual and the Modbus address list.

*7 Devices with the "RS485 interface" option are only suitable for an operating temperature range of -10 to +50 °C.

Power factor correction (PFC)

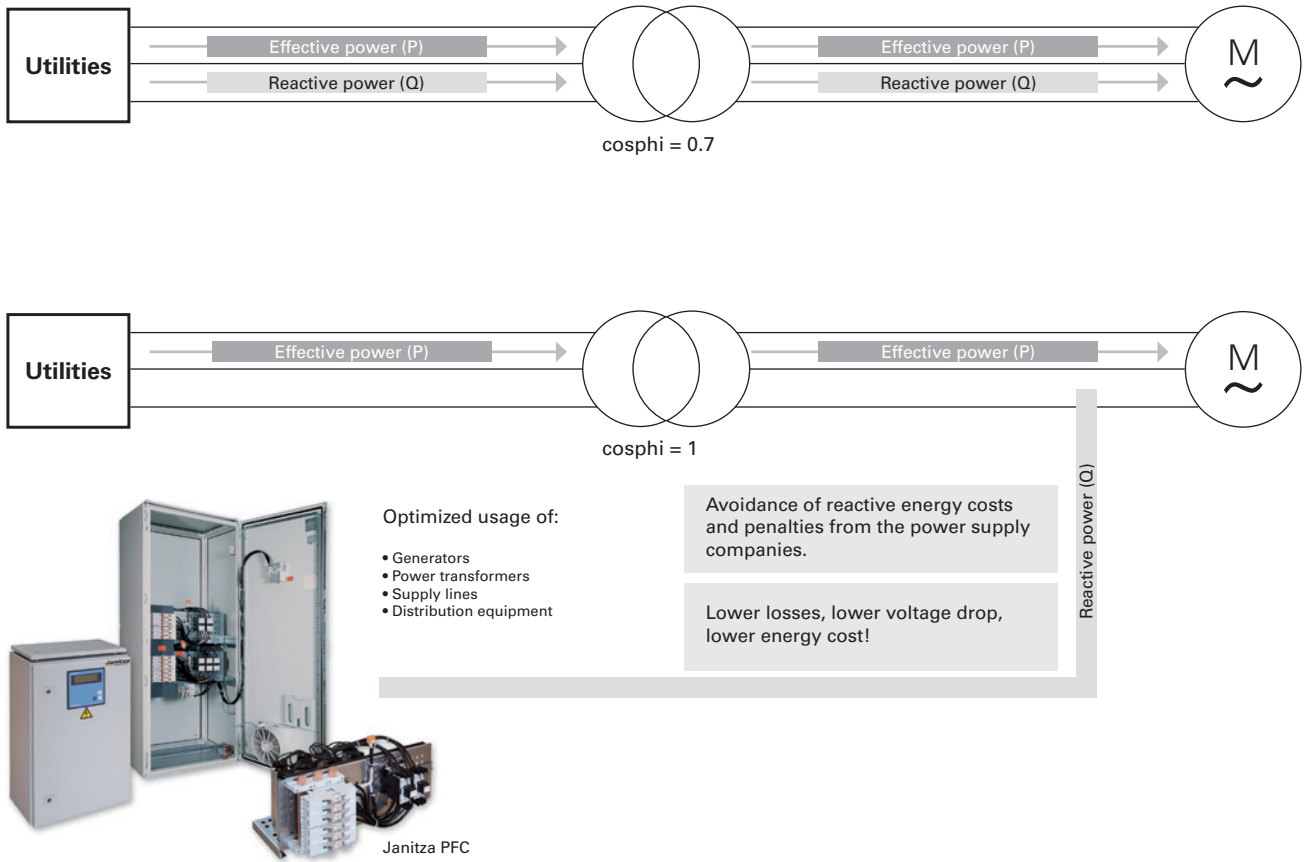

Fig.: Active and reactive power in the mains with PFC

Hybrid switching



Harmonics display



Dynamic PFC



Smart control



Prophi® 7 power factor controller

Interfaces / communication

- RS485

Communication / protocols

- Modbus RTU
- Modbus KTR
- ASCII Out
- Extern
- Slave Hybrid
- Slave Mode
- Master Mode

Triple Safety

- Temperature monitoring
- Monitoring the capacitor protective switching cycles
- Monitoring of over-current
- Single-phase reactive current compensation monitoring

Measuring voltage

- 3-phase
50–760 V (L-L), 30–440 V (L-N)

Power quality

- Harmonics up to the 33rd
- THD-U in %
- THD-I in %

Intelligent control

- Minimised number of switching cycles
- Compensated number of contactor switch cycles
- Optimised service life
- Mixed control (single and three-phase)
- Separate control of single-phase capacitors
- Sequential switching
- Cyclic switching

Switching outputs

- 15 relay outputs, freely programmable
- 12 transistor and 12 relay outputs for hybrid PFC

Alarm messages

- Undervoltage detection
- Overvoltage detection
- Under-compensation
- Measurement current exceedance
- Harmonics threshold values
- Delivery of active power
- Overtemperature
- Dropping below the measurement current
- C-defect
- Modbus error
- Switching cycle warning

Display mode

- Display three measured values simultaneously
- Graphical representation of harmonics in bar graph form
- Three-digit display of power factor (cos phi), switchable (tan phi)
- Display of controlled steps, fault messages and time
- Display of apparent current, active current and reactive current in display mode

Areas of application



- Automatically regulated power factor correction
- Choked power factor correction
- Harmonics filter
- Voltage stabilisation by means of dynamic PFC
- Mixed operation (hybrid switching) contactors and thyristor switching

Main features

- 12 or 13 switching outputs
- Extended measured voltage range (up to 760 V ~ L-L)
- Control of inductive compensation systems possible
- 20 pre-programmed control series
- Control series editor
- Graphical display 128 x 64 pixels
- Plain language menu navigation
- Four-quadrant operation
- Automatic initialisation
- Display of various grid parameters
- Display of harmonics
- Display of distortion factor THD-V / THD-I
- Monitoring of the capacitor current
- Saving of the maximum values
- Saving of the switching cycles and times
- Manual / Automatic mode
- Zero voltage shutdown
- Various error messages / alarm relay
- Error memory
- Test run of the system with error analysis
- Control of inductive compensation systems possible
- Voltage, current, frequency, active power, reactive power, apparent power
- Harmonics of the voltage (up to the 33rd / up to the 16th (even))
- Harmonics of the current (up to the 33rd / up to the 16th (even))

Alarm output programmable for ...

- Undervoltage detection / Overvoltage detection
- Under-compensation / Over-compensation
- Under-current / Over-current
- Harmonics threshold values
- Delivery of active power
- Overtemperature
- Message for delivery of active power
- Measured voltage error
- Switching cycle warning
- Modbus error
- C-defect

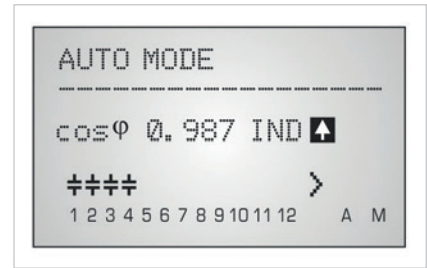

Fig.: Auto-Mode

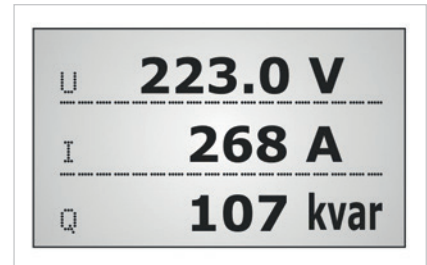

Fig.: Display-Mode

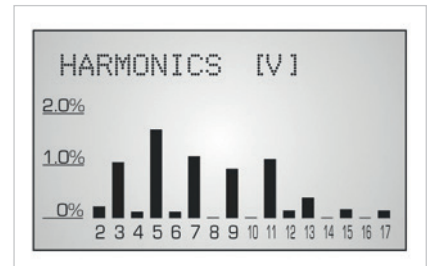

Fig.: Bargraph-Mode

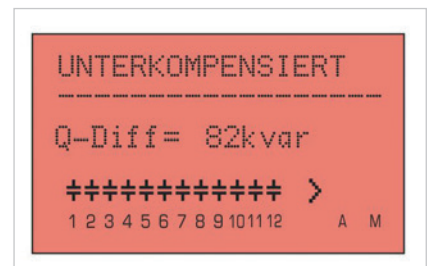

Fig.: Error message (customisable backlight)

Functional principle

- Single-phase/three-phase electronic measurement system
- Detection of the reactive and active current portion of the grid via the current and voltage circuit
- Switching in or out of the capacitor stages via the outputs in the event of deviations in the set power factor
- Switching of capacitors via contactors or semiconductors
- Regulation via capacitor air contactors is implemented in an optimised manner
- Transistor outputs for the near-realtime control of semiconductor switches

Fan control

- Development of fan control via integrated temperature sensors and a fan
- Uses the signal relay
- Programming of a lower or upper limit temperature necessary

LCD display

- Graphical display 128 x 64 pixels
- Display a comprehensive selection of measurement parameters

Overtemperature shut-down

- The overtemperature shut-down switches off the capacitor stages connected
- This results in the reduction of the interior temperature of the switching cabinet and protects the capacitors
- Programming of a lower or upper limit temperature as well as the pause time

Interface

- Two independent potential-free RS485 interfaces
- The Modbus RTU, Modbus KTR, ASCII out, Slave Hybrid, Slave Mode, and Master Mode protocols are available via the RS485s
- Integration of PLC systems, building management systems or energy management systems
- Modbus transfer rates: 9.6 – 256 kBit/s



Dimension diagrams

All dimensions in mm

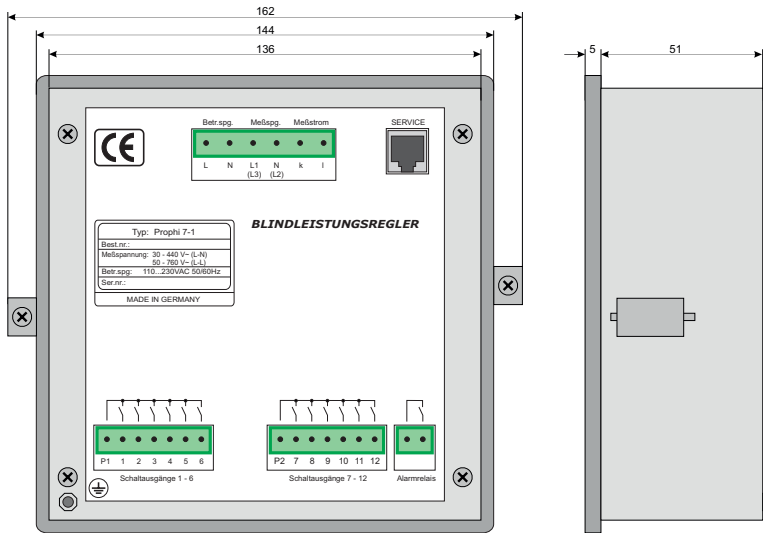

Rear side view

Side view

Cut out: 138^{+0,8} x 138^{+0,8} mm



Typical connection

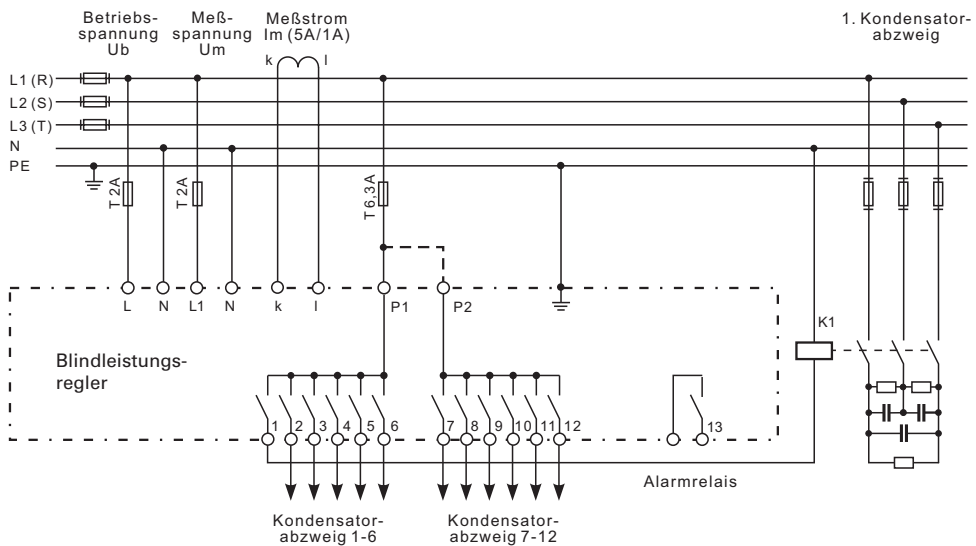

Fig.: Connection example for the Prophi® 7 power factor controller



Device overview and technical data

	Prophi® 7-I	Prophi® 7-III
Item number	14.16.028	14.16.037
Operating voltage 110 to 440 V ~ +/-15% 50/60 Hz	•	•
Measuring voltage 30 to 440 V ~ (L-N) 50/60 Hz 50 to 760 V ~ (L-L) 50/60 Hz	•	-
Measuring voltage 3 x 30 to 440 V ~ (L-N) 50/60 Hz 50 to 760 V ~ (L-L) 50/60 Hz	-	•
Changeover target cos phi 1/2	-	•
Outputs		
Relay outputs (conventional)	12	12
Transistor outputs (dynamic)*1	-	-
Interfaces (with Modbus)		
RS485 *1	-	•

*1 Prophi® 7 with RS485 and dynamic variant upon request

General	Prophi® 7
Use in low and medium voltage networks L-N or L-L	•
Accuracy voltage measurement (1-phase, L-N or L-L)	1 %
Accuracy current measurement (1-phase)	1 %
Accuracy cosphi measurement (sum L1-L3)	1 % *2,*3
Accuracy power measurement (sum L1-L3)	2 %
Accuracy frequency measurement	0,5 % *3
Accuracy harmonics measurement	2 %
RMS – momentary value	
Current, voltage, frequency	•
Effective, reactive and apparent power	•
Power factor	•
Recording of the mean values	
Power factor	•
Power quality measurement	
Harmonics per order / current and voltage, 1-phase	1. – 33., odd
Distortion factor THD-U in %, 1-phase	•
Distortion factor THD-I in %, 1-phase	•
Measured data recording	
Mean, minimum, maximum values	•
Displays and inputs / outputs	
Digital display, 6 buttons	•
Relay outputs (as switch output)	12 See overview of devices
Transistor outputs (as switch output)	12 See overview of devices
Alarm output (as switch output)	1
Digital input (for tariff changeover)	1 See overview of devices
Temperature sensor (internal)	1

*2 Applies to input currents > 0.2 A and in the cosphi range 0.85 to 1.00.

*3 In the range from -10 to +18 °C and 28 to 55 °C an additional error of ±0,2 % of the measurement value per K must be taken into account.

Communication	
Interface	
RS485: 9,6; 19,2; 38,4; 57,6; 115,2; 250; 256 kbps	See overview of devices
Protocols	
Modbus RTU	•
Error messages	
Under-voltage	•
Over-voltage	•
Dropping below the minimum measurement current	•
Measurement current exceedance	•
Insufficient compensation power	•
Delivery of active power	•
Harmonics threshold values	•
Overtemperature	•
Technical data	
Supply voltage L-L, L-N AC	See overview of devices
Measurement in which quadrants	4
Networks	TN, TT, (IT)
Measurement in multi-phase networks	3 ph
Measured voltage input	
Overvoltage category	CAT III
Measured range, voltage L-N, AC (without potential transformer)	See overview of devices
Measured range, voltage L-L, AC (without potential transformer)	See overview of devices
Voltage tolerance range	+10 % , -15 %
Back-up fuse	2 A ... 10 AT
Measurement surge voltage	4 kV
Test voltage relative to ground	2.200 V AC
Frequency measuring range	42 ... 80 Hz
Power consumption	max. 5 VA
Sampling rate	10 kHz (at 50 Hz)
Measured current input	
Signal frequency	45 Hz ... 1.200 Hz
Nominal current at .../5 A (.../1 A)	5 A (1 A)
Minimum measurement current	10 mA
Upper measurement current	5.3 A (sinusoidal)
Overloading	180 A for 2 sec.
Measurement rate	30 (50) measurements / sec.
Power consumption	approx. 0.2 VA
Updating the display	1 time per second
Zero voltage triggering	< 15 ms
Inputs and outputs	
Number of digital inputs (for tariff changeover)	1, see overview of devices
Relay outputs (as switch output)	13, see overview of devices
Back-up fuse	6,3 AT
Switching voltage	max. 250 V AC
Switching power	max. 1.000 W

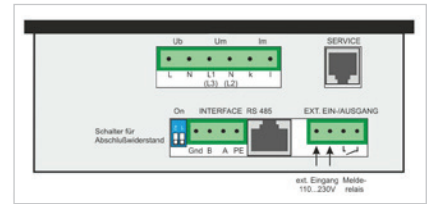

Fig.: Prophi® 7 interface

Max. switching frequency	50 Hz
Mechanical service life	> 30 x 10 ⁶ switching cycles
Electrical service life	> 2.8 x 10 ⁵ switching cycles
Transistor outputs (as switch output)	12, see overview of devices
Switching voltage	5 ... 30 V DC
Switching current	max. 50 mA
Max. switching frequency	50 Hz
Alarm output (as switch output)	1
Temperature sensor (internal)	1
Target cosphi changeover (current consumption)	Input 230 V AC
Mechanical properties	
Weight	1000 g
Device dimensions in mm (H x W x D)	144 x 144 x 53
Protection class per IEC 60529	Front: IP54, Rear: IP20
Installation	Front panel installation
Connecting phase (U / I), Single core, multi-core, fine-stranded Terminal pins, core end sheath	0.08 to 2.5 mm ² 1.5 mm ²
Features	
Display of capacitor currents	•
Display of switch-on times for the individual stages	•
Display of switching cycles per stage	•
Zero voltage triggering	•
Automatic configuration	•
Password protection	•
Environmental conditions	
Temperature range	Operation: -10 ... +55 °C *4 Storage: -20 ... +60 °C
Relative humidity	15 to 95 %
Operating altitude	0 ... 2,000 m above sea level
Degree of pollution	2
Mounting position	any
Electromagnetic compatibility	
Electromagnetic compatibility of equipment	Directive 2004/108/EC
Electrical appliances for application within particular voltage limits	Directive 2006/95/EC
Equipment safety	
Safety requirements for electrical equipment for measurement, regulation, control and laboratory use – Part 1: General requirements	IEC/EN 61010-1
Part 2 – 008: Particular requirements for testing and measuring circuits	IEC/EN 61010-1-08
Protection class	I = Device with protective conductor
Noise immunity	
Industrial environment	DIN EN 61326-1, Table 2; (IEC 61326-1)
Emissions	
Class B: Residential environment	DIN EN 61326-1; (IEC 61326-1)
Class A: Industrial environment	DIN EN 61326-1; (IEC 61326-1)
Safety	
Europe	CE labelling

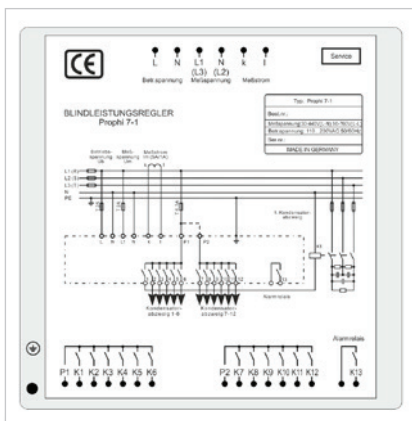

Fig.: Prophi® 7, rear view

Comment: For detailed technical information please refer to the operation manual and the Modbus address list.

*4 Devices with the "RS485 interface" option are only suitable for an operating temperature range of -10 to +50 °C.





The universal capacitor monitoring system

Continuous capacitor monitoring

- Over-current limit value
- Under-current limit value
- Unbalance limit value
- Temperature limit value
- Harmonics limit value
- Voltage limit value
- Number of switching cycles

Safety

- Timely detection of capacitor aging
- Timely replacement of contactors
- Prevention of fire damage
- Prevention of downtimes

Interfaces

- Ethernet
- RS232
- RS485

Communication

- Profibus (DP/ V0)
- Modbus (RTU, TCP, Gateway)
- TCP/IP
- BACnet (optional)
- HTTP (Homepage)
- FTP (file transfer)
- SNMP
- TFTP
- NTP (time synchronisation)
- SMTP (email function)
- DHCP

Power quality

- Harmonics up to 40th harmonic
- Short term interruptions
- Transient recorder (> 50 μ s)
- Inrush currents (> 20 ms)
- Imbalance
- Full cycle RMS recordings (up to 4.5 min.)

Measured data memory

- 128 MByte Flash
- 16 MB RAM

2 digital outputs

- Pulse output kWh / kvarh
- Switch output
- Threshold value output
- Logic output

Thermistor input

- PT100, PT1000, KTY83, KTY84

PFC protection – Capacitor monitoring Item no.: 52.16.300

- Increases the safety of PFC systems
- Monitoring of all overload scenarios by means of the UMG 604E
- Timely detection of capacitor overloading as well as short circuits

Main features

- Measurement 3-phase, 3 CTs in the supply line for the PFC system
- PFC-APP (Jasic® monitoring software on UMG 604E)
- Monitoring of: Short-circuit to ground, over-current and under-current, overvoltage, unbalance, switching frequency, temperature, etc.
- Additional, comprehensive network analysis functions
- Extensive analysis options via GridVis®-Basic software
- Integration into networks with Ethernet or RS485-Modbus RTU
- Flexible alarm system with monitoring of up to 32 measured values
- Menu-driven user guidance in plain text on the UMG 604E homepage

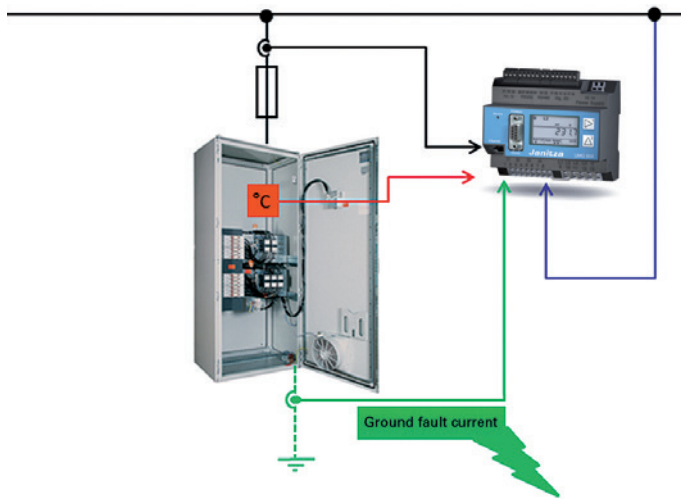

Fig.: Monitoring of short-circuits to ground, temperature, over-current etc. with the power analyser UMG 604E



Fig.: Capacitor monitoring in a PFC system



Fig.: Monitoring of limit values via UMG 604 homepage

Segmented film



Self-healing



Low loss



Long service life



PFC power capacitors

High tolerance of inrush currents

- Optimised metal spraying process
- Wave-cut film

Long service life

- Highend impregnation technology
- Good thermal dissipation
- High quality base materials

Reliable connection technology

- Connection adapter for reliable long term connections

Fivefold safety

- Self-healing technology
- Dry technology
- Over-pressure disconnecter
- Segmented capacitor film
- Integrated discharge device

Areas of application



- Motor fixed PFC
- Group PFC
- Automatic power factor correction
- Detuned power factor correction systems
- Harmonics filter
- Dynamic power factor correction systems

Main features

Fivefold safety

- Self-healing technology
- Dry technology
- Over-pressure disconnecter
- Segmented capacitor film
- Integrated discharge device

Long service life (up to 170,000 hours) and high operational reliability

- Highend impregnation technology
- Excellent thermal dissipation
- High quality base materials

Reliable connection technology

- Connection adapter for reliable long term connections

High inrush currents withstand capability

- Optimised metal spraying process
- Wave-cut film design

High of overload withstand capability

- Max. over-current: 2.2 I_n
- Max. inrush current: 300 x I_n

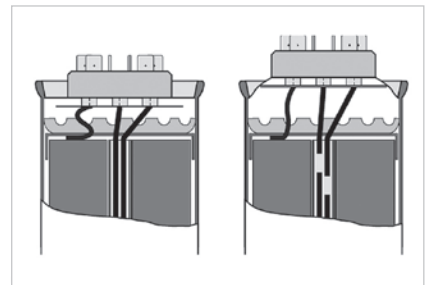

Fig.: Principle of over-pressure disconnecter



Fig.: Self-healing, segmented capacitor film



Fig.: The connection adapter offers a low transfer resistance and a permanent, fixed electrical and mechanical contact

Low loss

- 0.2 Watt/kvar dielectric loss
- 0.5 Watt/kvar total power dissipation

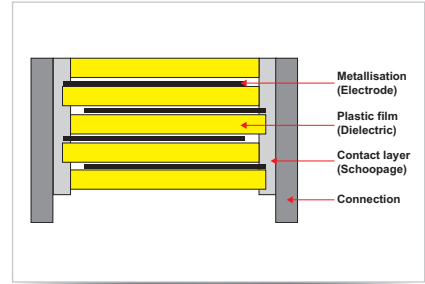

Fig.: Contacting (metal spraying) of the metallised Polypropylene film (Dielectric)



Technical data

Technical data and limit values for power capacitors		
Standards		IEC 60831-1+2, EN 60831-1+2
Output range	QR (kvar)	0.3 – 40
Nominal voltage range	UR (V)	400 V*1
Over-voltage	U_{max}	$U_n + 10\%$ (up to 8 h daily) / $U_n + 15\%$ (up to 30 mins daily) $U_n + 20\%$ (up to 5 mins daily) / $U_n + 30\%$ (up to 1 min daily)
Overcurrent	I_{max}	$2.2 \times I_n$ (at nominal voltage, 50 Hz)
Inrush current withstand capability	IS	Up to $300 \times I_n$
Dielectric losses	Pdiel.	< 0.2 Watt per kvar
Total capacitor losses	Pv	< 0.5 Watt per kvar
Nominal frequency	f	50 / 60 Hz
Capacitor tolerance		-5 ... + 10 %
Test voltage (terminal / terminal)	VTT	$2.15 \times U_n$, AC, 2 s / $1.85 \times U_n$, AC, 18 s
Test voltage (terminal / housing)	VTC	3,900 V, 2 s
Service life expectancy	t LD(Co)	Up to 170,000 h
Ambient temperature		Class: -25/D Max. temperature +65 °C Max. 24 h average = +45 °C Max. 1 year average = +35 °C Lowest temperature = -40 °C
Max. housing temperature	Tg	+75 °C
Air humidity	H _{rel}	max. 95 %
Operating altitude		max. 4,000 m above sea level
Fastening and grounding		M12 threaded bolts and house base
Safety		Dry technology, over-pressure disconnecter, self-healing, max. permissible fault current 10,000 A per UL-810 standard
Discharging		Discharge resistors
Housing		Aluminium can and sheet steel housing
Protection class		IP20, indoor installation (optionally with IP54 terminal covering)
Dielectric		Polypropylene film
Impregnation		Dry
Number of switching cycles per year		Max. 60,000 switching cycles in accordance with IEC 60831 (with capacitor contactors)

*1 Nominal voltage 400 V illustrated in the catalogue. 230 – 800 V on request.

3-phase power capacitors in aluminium cans

Main features

- PFC power capacitors in aluminium cans
- Delta connection
- With discharge resistors
- Long service life, low loss



Dimension diagrams

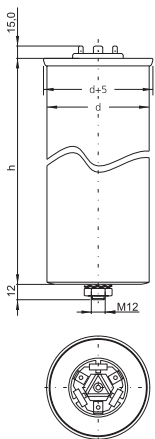

Capacitor with
d = 60 / 70 mm
for connection with
flat connector
6.3 x 0.8 mm

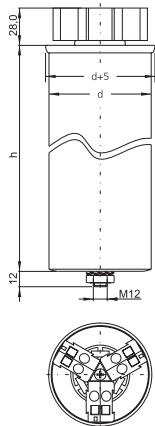

Capacitor with
connection
adapter ASS 1
d = 60 / 70 mm

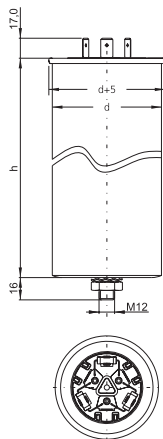

Capacitor with
d = 85 mm
for connection with
flat connector 9.5 x 1.2 mm

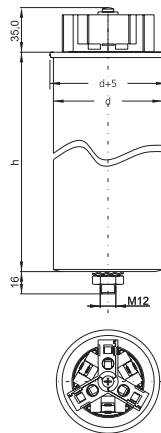

Capacitor with
connection
adapter ASS 2
d = 85 mm

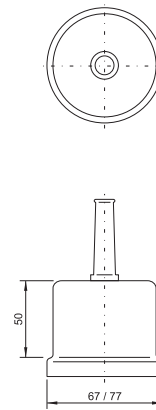

Protective cap SK60 / SK70 for
Capacitor with d = 60 / 70 mm
(not available for capacitors
with d = 85 mm)



Technical data

Delta connection with discharge resistor - Protection type: IP00 – Frequency: 50 Hz										
Nominal output in kvar at a nominal voltage of:					Type	Capacitance in μF -5 ... + 10 %	Dimensions in mm (D x H)	Weight in kg	Item no.	
400 V	415 V	440 V	480 V	525 V						
2.4	2.6	2.9	3.5	4.17	JCP525/4.1-D	3 x 16.0	60 x 225	0.7	19.02.275	
2.5	2.7	3.0	3.6	4.3	JCP480/3.6-D	3 x 16.6	60 x 150	0.5	19.02.205	
4.8	5.2	5.8	7	8.33	JCP525/8.3-D	3 x 32.0	70 x 225	0.9	19.02.249	
5	5.4	6	7.2	8.6	JCP480/7.2-D	3 x 33.2	60 x 225	0.8	19.02.210	
5.8	6.3	7	8.33	10	JCS525/10.0-D	3 x 38.5	70 x 225	0.8	19.02.150	
6.25	6.7	7.6	9.0	-	JCP440/7.6-D	3 x 41.7	60 x 225	0.7	19.02.211	
7.2	7.8	8.7	10.5	12.5	JCS525/12.5-D	3 x 48.1	70 x 225	1.1	19.02.180	
8.7	9.4	10.5	12.5	15	JCS525/15.0-D	3 x 57.7	70 x 265	1.2	19.02.103	
7.5	8.1	9.1	10.8	-	JCP440/9.1-D	3 x 49.9	60 x 225	0.7	19.02.215	
10	10.8	12.1	14.4	-	JCP440/12.1-D	3 x 66.3	70 x 225	1.1	19.02.217	
10.8	11.6	13.1	15.5	-	JCS480/15.5-D	3 x 71.4	70 x 225	1.1	19.02.116	
9.3	10	11.2	-	-	JCP400/9.3-D	3 x 61.4	70 x 225	1.1	19.02.219	
10	10.8	12.1	-	-	JCP400/10.0-D	3 x 66.3	70 x 225	1.1	19.02.220	
11.7	12.5	14.1	-	-	JCP400/11.7-D	3 x 77.3	70 x 225	1.1	19.02.221	
12.5	13.4	15.1	-	-	JCS440/15.0-D	3 x 82.9	70 x 225	1.1	19.02.125	
20	-	24.2	-	-	JCP400/20.0-D	3 x 132.6	85 x 285	2.4	19.02.228	
23.3	25.1	28.2	-	-	JCS440/28.2-D	3 x 154.6	85 x 355	2.5	19.02.126	
25	29.9	30.2	-	-	JCS440/30.0-D	3 x 164.4	85 x 355	2.6	19.02.127	

Protective caps / connection adapter	Type		Item no.
Protective cap with cable entry Height +77 mm	SK60	For power capacitors with a diameter of 60 mm	19.02.620
Protective cap with cable entry Height +75 mm	SK70	For power capacitors with a diameter of 70 mm	19.02.621
Connection adapter for D 60 / 70 mm with spring type terminals 2 x 6 mm ²	ASS 1	Height = 28 mm	19.02.610
Connection adapter for D85 mm with spring type terminals 16 mm ²	ASS 2	Height = 30.5 mm	19.02.612

Optimised,
thermal design



Self-healing



Low loss



Long service life



Automatic power factor correction systems without reactors

**High tolerance of start-up currents
inrush current withstand capability**

- Optimised metal spraying process
- Wave-cut film design
- Capacitor contactors with pre-closing contacts for inrush current damping

Long service life

- Generous space- / power-ratio
- Generously dimensioned cooling system
- High quality capacitors

High operational reliability

- Capacitors with fivefold safety system
- PFC controller with 8-way alarm message
- Heavy duty sheet steel cabinets
- Optimised thermal design
- Exclusive use of quality components

Areas of application



- Automatic Power Factor Correction (APFC)
- For use in mains supply with low harmonics distortion
- Converter power (non-linear loads) < 15 % of total connection power
- Total harmonic distortion of THD-U < 3 %
- No combined use in networks with de-tuned capacitors
- No use with critical ripple control systems in the range 270 to 425 Hz



Device overview and technical data

Power factor correction without reactors		
Standards	DIN, VDE 0660 part 500, EN 60439-1 and EN 60831-1/2	
Design	DIN EN 60439 part 1, partial type-approved combination	
Construction type	Sheet steel cabinet for versions KB and ES, module for version MO	
PFC controller	Prophi® per datasheet or selection table	
Power capacitors	High quality, self-healing, polypropylene 3-phase capacitors using dry technology	
Contactors	Specific capacitor contactors with pre-charging resistors	
Capacitor protection	HRC fuses, 3-phase, per capacitor stage	
Nominal voltage	400 V, 50 Hz (other voltages on request)	
Control voltage	230 V, 50 Hz (other voltages on request)	
Output range	10 – 600 kvar (alternative staging, powers on request)	
Capacitor nominal voltage	440 V without reactors	
Voltage withstand capability of capacitors	8 h daily	484 V
	30 min daily	506 V
	5 min	528 V
	1 min	572 V
Power dissipation	Capacitors < 0.5 W/kvar, systems 4 – 7 W/kvar	
Switching cycles capacitor contactors	max. 100,000 switching cycles	
Current transformer connection	... /1 A, .../5 A	
Control ratio	See overview of variants	
Discharging	With discharge resistors per EN 60831-1/2	
Maximum altitude	Up to 2,000 m above sea level	
Ambient temperature	35 °C per DIN EN 60439 part 1 (temperature class of the capacitors should be assured with adequate ventilation/cooling at the place of installation!)	
Protection class	Cabinet version = IP32 / Slide-in module = IP00	
Type of cooling	Forced ventilation (except slide-in modules)	
Colour	Grey, RAL 7035 (other colours on request)	
Noise emission (FK)	< 60 dB with closed systems at 1 m distance	
Connection cross-section and fuse	See technical annex	

Automatic power factor correction in modular design (up to 500 kvar ...)

Main features

- APFC in the steel cabinet
- For free-standing installation
- Nominal voltage: 400 V, 3-phase, 50 Hz
- Protection class: IP32
- With natural convection (air exchange)
- With discharge resistors
- With power factor controller Prophi® 6R/12R



Dimension diagrams

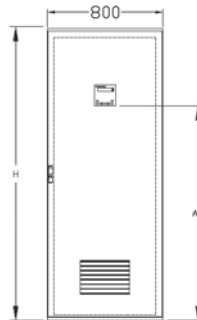
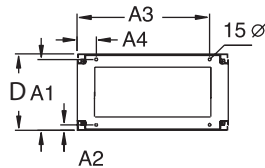

ES8184 (dimensions in mm):
 H = 1820, W = 800, D = 400
 A1 = 374, A2 = 25, A3 = 700, A4 = 100
 A5 = 1,480



Technical data

APFC in modular design ES8184							
Nominal output kvar	Stage power kvar	Control ratio	Type	Width in mm	Weight in kg	Item no.	
150	25/25/50/50	1:1:2:2	JF440/150ER6ES8184**	800	208	50.81.400	
150	12.5/12.5/25/50/50	1:1:2:4:4	JF440/150ER12ES8184**	800	208	50.81.415	
150	25/25/25...	1:1:1:1:1:1	JF440/150ER6ES8184**	800	208	50.81.425	
160	20/20/40...	1:1:2:2:2	JF440/160ER8ES8184**	800	209	50.81.450	
175	25/50/50/50	1:2:2:2	JF440/175ER7ES8184**	800	210	50.81.475	
175	12.5/12.5/25/25/50...	1:1:2:2:4:4	JF440/175ER14ES8184***	800	210	50.81.490	
180	20/40/40...	1:2:2:2:2	JF440/180ER9ES8184**	800	211	50.81.515	
200	50/50...	1:1:1:1	JF440/200ER4ES8184**	800	212	50.81.540	
200	25/25/50...	1:1:2:2:2	JF440/200ER8ES8184**	800	212	50.81.550	
200	12.5/12.5/25/50...	1:1:2:4:4...	JF440/200/ER16ES8184**	800	212	50.81.560	
200	20/20/40...	1:1:2:2:2:2	JF440/200ER10ES8184**	800	212	50.81.570	
240	20/20/40...	1:1:2:2...	JF440/240ER12ES8184***	800	232	50.81.600	
250	50...	1:1:1:1:1	JF440/250ER5ES8184**	800	233	50.81.625	
250	25/25/50...	1:1:2:2...	JF440/250ER10ES8184**	800	233	50.81.635	
250	12.5/12.5/25/50...	1:1:2:4:4...	JF440/250ER20ES8184***	800	233	50.81.645	
300	50/50...	1:1:1:1:1:1	JF440/300ER6ES8184**	800	236	50.81.670	
300	25/25/50...	1:1:2:2...	JF440/300ER12ES8184***	800	236	50.81.680	
300	12.5/12.5/25/50...	1:1:2:4:4...	JF440/300ER24ES8184***	800	236	50.81.690	
400	50/50/50...	1:1...	JF440/400ER8ES8184**	2 x 800	475	50.81.693	
500	50/50/50...	1:1...	JF440/500ER10ES8184***	2 x 800	500	50.81.696	
Accessories							
Socket 100 mm high	SO 100/800/400				5	29.03.317	
Socket 200 mm high	SO 200/800/400				10	29.03.322	

** With power factor controller Prophi® 6R
 *** With power factor controller Prophi® 12R

Other rated voltages, frequencies, kvar-outputs, mechanical configurations or variants with circuit breakers on request. Expansion units, systems in ISO housing as well as audio frequency blocking devices on request.

Automatic power factor correction on extractable module, up to 100 kvar

Main features

- Ready-to-install PFC slide-in modules without reactors
- For cabinet installation
- Nominal voltage: 400 V, 3-phase, 50 Hz
- Protection class: IP00
- With natural convection (air exchange)
- With discharge resistors

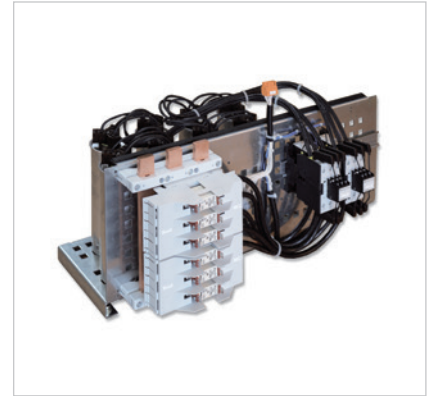

Dimension diagrams

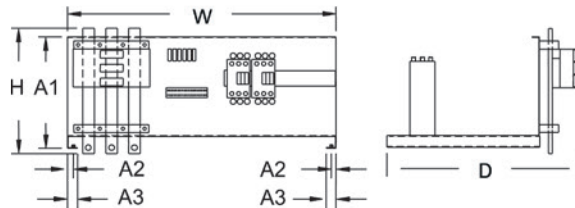

MO84 (dimensions in mm):
 H = 330, W = 703, D = 333
 A1 = 290, A2 = 14, A3 = 26.5



Technical data

PFC module M084					
Nominal output kvar	Stage power kvar	Control ratio	Type	Weight in kg	Item no.
50	50		JF440/50EK1MO84	22	50.80.700
50	25/25	1:1	JF440/50/2EK2MO84	22	50.80.740
50	10/20/20	1:2:2	JF440/50/3EK5MO84	22	50.80.770
50	12.5/12.5/25	1:1:2	JF440/50/3/EK4MO84	22	50.80.774
60	20/40	1:2	JF440/60/2EK3MO84	23	50.80.775
60	10/10/20/20	1:1:2:2	JF440/60/4EK6MO84	23	50.80.776
75	25/50	1:2	JF440/75/2EK3MO84	24	50.80.800
75	25/25/25	1:1:1	JF440/75/3EK3MO84	24	50.80.810
75	12.5/12.5/25/25	1:1:2:2	JF440/75/4EK6MO84	24	50.80.811
80	40/40	1:1	JF440/80/2EK2MO84	24	50.80.835
80	20/20/40	1:1:2	JF440/80/3EK4MO84	24	50.80.837
100	50/50	1:1	JF440/100/2EK2MO84	25	50.80.875
100	25/25/50	1:1:2	JF440/100/3EK4MO84	25	50.80.880
100	25/25/25/25	1:1:1:1	JF440/100/4EK4MO84	25	50.80.900
100	20/40/40	1:2:2	JF440/100/3EK5MO84	25	50.80.902
100	12.5/12.5/25/50	1:1:2:4	JF440/100/4EK8MO84	25	50.80.903
Control module with Prophi® 6R controller MCCB, CT terminals and 2 m connection cable (mounted on the capacitor module)					50.80.003
Control module with Prophi® 12R controller MCCB, CT terminals and 2 m connection cable (mounted on the capacitor module)					50.80.004
Accessories Set module fixing rail for Rittal cabinets, left/right, with accessories (for Rittal cabinet MO84)					50.00.100

Other rated voltages, frequencies, outputs, mechanical configurations or variants with circuit breakers on request.

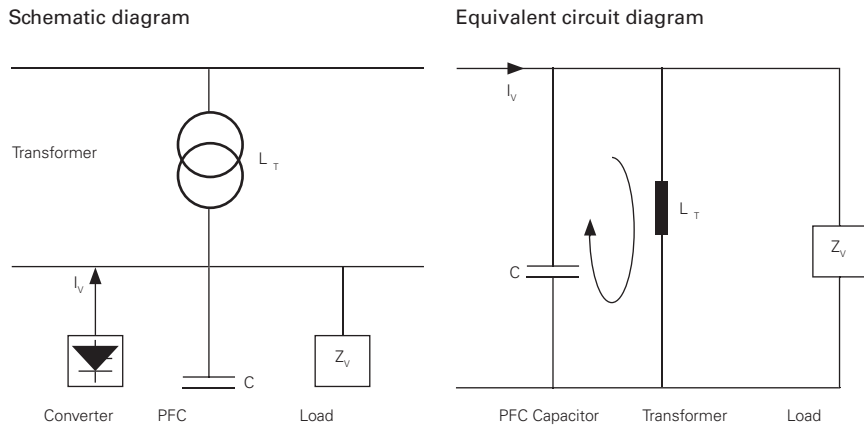

Fig.: Parallel resonant circuit between transformer and capacitors without reactors

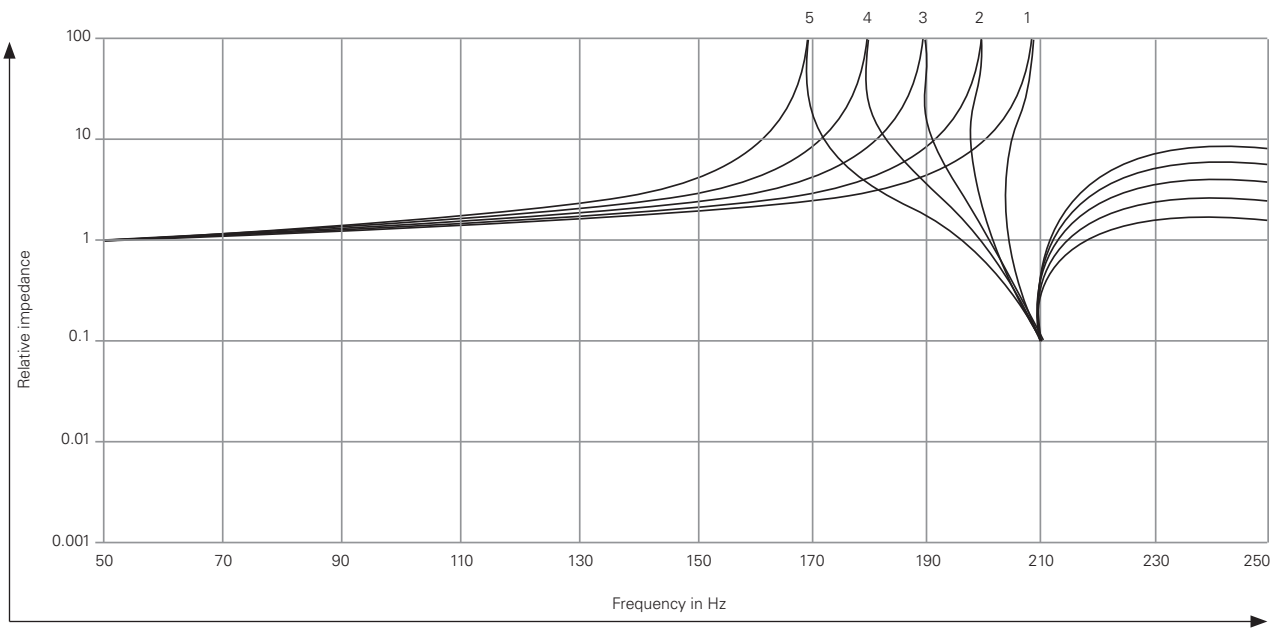
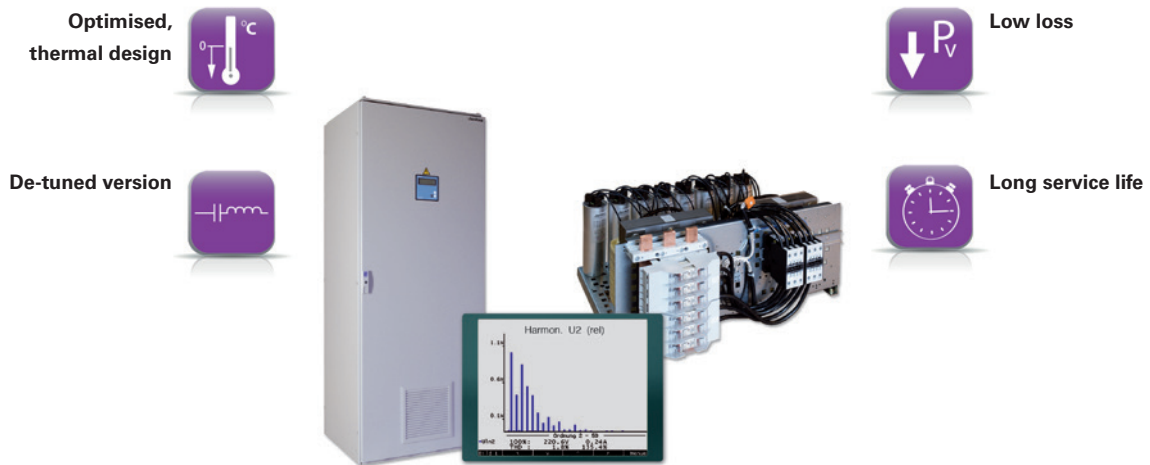

Fig.: Relative impedance progression for parallel resonant circuit with detuned capacitor and transformer

- $U_k = 4 \%$
- $p = 5.67 \%$
- 1... $Q_C / S_N = 5 \%$
- 2... $Q_C / S_N = 15 \%$
- 3... $Q_C / S_N = 30 \%$
- 4... $Q_C / S_N = 50 \%$
- 5... $Q_C / S_N = 80 \%$
- $Q_C = \text{PFC output}$
- $S_N = \text{Apparent power of transformer}$



Automatic de-tuned power factor correction systems

Optimised filter design

- Precise filter circuit frequency matching
- High quality reactors
- Temperature protection in the event of overload
- Filter circuit reactors with high linearity and low loss

Long service life

- Generous space- / power-ratio
- Generously dimensioned cooling system
- High quality capacitors and filter circuit reactors with 100 % duty cycle

High operational reliability

- Capacitors with fivefold safety
- PFC controller with 8-way alarm message
- Optimised thermal design
- Exclusive use of quality components

Areas of application



- Automatic power factor correction with reactors
- For use in mains supply with harmonics distortion
- Converter power (non-linear loads) > 15 % of the connection power
- Total harmonic distortion of THD-U > 3 %
- To prevent cases of resonance
- Harmonics filtering and improvement of power quality
- Reduction in reactive energy costs and PFC penalties



Device overview and technical data

De-tuned power factor correction				
Technical data				
Standards	DIN, VDE 0660 part 500, EN 60439-1 and EN 60831-1/2			
Design in accordance with	DIN EN 60439 part 1, partial type-approved combination			
Construction type	Sheet steel cabinet for versions KB and ES, module for version MO			
Dynamic PFC controller	Prophi® per datasheet or selection table			
Power capacitors	High quality, self-healing, polypropylene 3-phase capacitors using dry technology			
Filter circuit reactors	Low-loss 3-phase reactors with high linearity, 7%, 14% (other ratings on request), with 100% duty cycle			
Contactors	Specific capacitor contactors			
Capacitor protection	HRC fuses, 3-phase, per capacitor stage			
Nominal voltage	400 V, 50 Hz (other voltages on request)			
Control voltage	230 V, 50 Hz (other voltages on request)			
Output range	10 – 600 kvar (alternative staging, outputs on request)			
Capacitor nominal voltage	440 V with 5.67 – 7 % (detuned), 525 V with 14 % (detuned)			
Voltage withstand capability of capacitors	At p = 5.67 – 7 %	440 V	At p = 14 %	525 V
	8 h daily	484 V		577 V
	30 min daily	506 V		604 V
	5 min	528 V		630 V
	1 min	572 V		682 V
Power dissipation	Capacitors < 0.5 W/kvar, systems 4 – 7 W/kvar			
System design	Permissible harmonics currents		Harmonics voltage	
	I 250 Hz	I 350 Hz	U 250 Hz	U 350 Hz
FK 5.67	0.565 IN	0.186 IN	5 %	5 %
FK 7	0.31 IN	0.134 IN	5 %	5 %
FK 14	0.086 IN	0.051 IN	5 %	5 %
Switching cycles capacitor contactors	max. 100,000 switching cycles			
Current transformer connection	... /1 A, .../5 A			
Control ratio	See overview of variants			
Discharging	With discharge resistors per EN 60831-1/2			
Maximum altitude	Up to 2,000 m above sea level			
Ambient temperature	35 °C per DIN EN 60439 part 1 (temperature class of the capacitors should be assured with adequate ventilation/cooling at the place of installation!)			
Protection class	Cabinet version = IP32 / Slide-in module = IP00			
Type of cooling	Forced ventilation (except slide-in modules)			
Colour	Grey, RAL 7035 (other colours on request)			
Noise emission (FK)	< 60 dB with closed systems at 1 m distance			
Connection cross-section and fuse	See technical annex			
The following reactors can be used in mains supply with ripple control systems:				
Ripple control frequency	De-tuning factor		Filter series resonant frequency	
< 168 Hz	p = 14 %		fr = 134 Hz	
168 – 183 Hz	p = 14 / 5.67 %		fr = 134 / 210 Hz	
> = 216.67	p = 8 %		fr = 177 Hz	
> 228 Hz	p = 7 %		fr = 189 Hz	
> 350 Hz	p = 5.67 %		fr = 210 Hz	

Automatic de-tuned power factor correction (Harmonics filter), compact design

Main features

- APFC in the steel cabinet
- For wall mounting
- Nominal voltage: 400 V, 3-phase, 50 Hz
- Reactors: 7 % and 14 %
- Protection class: IP32
- Ventilation: From 31 kvar with fan in the cabinet door for forced cooling
- With discharge resistors
- With power factor controller Propfi® 6R



Dimension diagrams

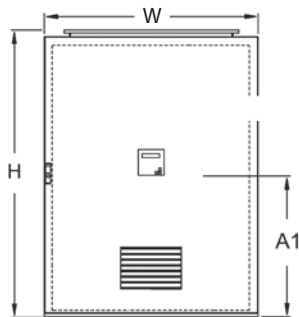

KB6825 (dimensions in mm):

W = 600, H = 800, D = 250, A1 = 410

KB6123 (dimensions in mm):

W = 600, H = 1,200, D = 300, A1 = 655



Technical data

7 % de-tuned in accordance with series resonant frequency 189 Hz						
Nominal output kvar	Stage power kvar	Control ratio	Type	Design	Weight in kg	Item no.
15	5/10	1:2	JF440/15ER3KB6825FK7	KB6825	112	50.52.020
20	5/5/10	1:1:2	JF440/20ER4KB6825FK7	KB6825	113	50.52.040
25	5/10/10	1:2:2	JF440/25ER5KB6825FK7	KB6825	116	50.52.080
31	6.25/12.5/12.5	1:2:2	JF440/31/ER5KB6825FK7	KB6825	118	50.52.110
35	5/10/20	1:2:4	JF440/35ER7KB6825FK7	KB6825	122	50.52.150
43.75	6.25/12.5/25	1:2:4	JF440/43.75ER7KB6825FK7	KB6825	138	50.52.180
50	10/20/20	1:2:2	JF440/50ER5KB6825FK7	KB6825	142	50.52.210
60	10/20/30	1:2:3	JF440/60ER6KB6123FK7	KB6123	158	50.52.225
75	12.5/25/37.5	1:2:3	JF440/75ER6KB6123FK7	KB6123	167	50.52.240

Other rated voltages, frequencies, outputs, reactors, mechanical configurations or variants with circuit breakers on request.

14 % de-tuned in accordance with series resonant frequency 134 Hz						
Nominal output kvar	Stage power kvar	Control ratio	Type	Design	Weight in kg	Item no.
15	5/10	1:2	JF525/15ER3KB6825FK14	KB6825	123	50.52.520
20	5/5/10	1:1:2	JF525/20ER4KB6825FK14	KB6825	124	50.52.540
25	5/10/10	1:2:2	JF525/25ER5KB6825FK14	KB6825	128	50.52.580
31	6.25/12.5/12.5	1:2:2	JF525/31/ER5KB6825FK14	KB6825	130	50.52.610
35	5/10/20	1:2:4	JF525/35ER7KB6825FK14	KB6825	134	50.52.650
43.75	6.25/12.5/25	1:2:4	JF525/43.75ER7KB6825FK14	KB6825	152	50.52.680
50	10/20/20	1:2:2	JF525/50ER5KB6825FK14	KB6825	173	50.52.710
60	10/20/30	1:2:3	JF525/60ER6KB6123FK14	KB6123	184	50.52.725
75	12.5/25/37.5	1:2:3	JF525/75ER6KB6123FK14	KB6123	195	50.52.729

Other rated voltages, frequencies, outputs, reactors, mechanical configurations or variants with circuit breakers on request.

7 % de-tuned power factor correction (harmonics filter), extractable design ES8206 FK7

Main features

- APFC in steel cabinet (free-standing mounting)
- Nominal voltage: 400 V, 3-phase, 50 Hz
- Reactor: 7 % (189 Hz series resonant frequency)
- Protection class: IP32
- Ventilation: From 120 kvar with fan in the cabinet door for forced cooling
- With power factor controller Prophi® 6R/12R



Dimension diagrams

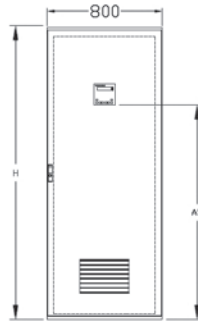
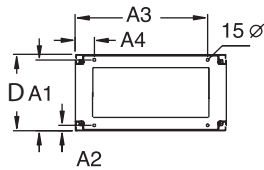

ES8206 (dimensions in mm):
H = 2.020, W = 800 or 1.600, D = 600
A1 = 537, A2 = 63, A3 = 737, A4 = 62, A5 = 1,480



Technical data

Nominal output kvar	Stage power kvar	Control ratio	Type	Width in mm	Weight in kg	Item no.
60	10/20/30	1:2:3...	JF440/60ER6ES8206FK7**	800	278	50.89.040
75	12.5/12.5/25...	1:1:2...	JF440/75ER6ES8206FK7**	800	278	50.89.080
100	25/25/50	1:1:2	JF440/100ER4ES8206FK7**	800	288	50.89.120
100	12.5/12.5/25/50	1:1:2:4	JF440/100ER8ES8206FK7**	800	288	50.89.200
120	20/20/40/40	1:1:2:2	JF440/120ER6ES8206FK7**	800	340	50.89.320
150	25/25/50/50	1:1:2:2	JF440/150ER6ES8206FK7**	800	344	50.89.400
175	25/50/50/50	1:2:2:2	JF440/175ER7ES8206FK7**	800	367	50.89.440
200	50...	1:1:1...	JF440/200ER4ES8206FK7**	800	314	50.89.480
200	25/25/50...	1:1:2...	JF440/200ER8ES8206FK7**	800	314	50.89.520
200	12.5/12.5/25/50...	1:1:2:4..	JF440/200ER16ES8206FK7**	800	314	50.89.560
250	50...	1:1:1...	JF440/250/ER5ES8206FK7**	800	437	50.89.600
250	25/25/50...	1:1:2...	JF440/250ER10ES8206FK7**	800	437	50.89.640
300	50...	1:1:1...	JF440/300ER6ES8206FK7**	800	487	50.89.685
300	25/25/50...	1:1:2...	JF440/300ER12ES8206FK7***	800	498	50.89.687
350	50...	1:1:1...	JF440/350ER7ES8206FK7-1S***	800	520	50.89.720
350	50...	1:1:1...	JF440/350ER7ES8206FK7***	1,600	352/347	50.89.722
400	50...	1:1:1...	JF440/400ER8ES8206FK7-1S***	800	570	50.89.744
400	50...	1:1.1...	JF440/400ER8ES8206FK7***	1,600	2x370	50.89.740
450	50...	1:1:1...	JF440/450ER9ES8206FK7***	1,600	437/347	50.89.770
500	50...	1:1:1...	JF440/500ER10ES8206FK7***	1,600	479/359	50.89.800
550	50...	1:1:1...	JF440/550ER11ES8206FK7***	1,600	2x431	50.89.805
600	50...	1:1:1...	JF440/600ER12ES8206FK7***	1,600	2x481	50.89.820

Accessories

100 mm high socket for easy supply cable connection	SO 100 / 800 / 600	5	50.00.150
200 mm high socket for easy supply cable connection	SO 200 / 800 / 600	10	50.00.151

Other rated voltages, frequencies, outputs, reactors, mechanical configurations or variants with circuit breakers on request.
** With Prophi® 6R, *** With Prophi® 12R

14 % de-tuned power factor correction (harmonics filter), extractable design ES8206 FK14

Main features

- APFC in steel cabinet (free-standing mounting)
- Nominal voltage: 400 V, 3-phase, 50 Hz
- Reactors: 14 % (134 Hz series resonant frequency)
- Protection class: IP32
- Ventilation: From 120 kvar with fan in the cabinet door for forced cooling
- With power factor controller Prophi® 6R/12R



Dimension diagrams

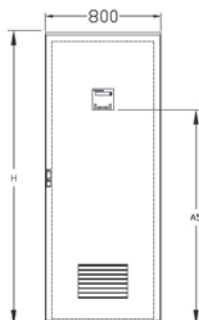
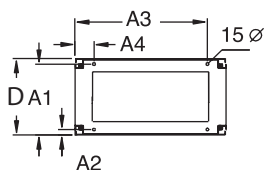

ES8206 (dimensions in mm):

H = 2.020, W = 800 or 1.600, D = 600

A1 = 537, A2 = 63, A3 = 737, A4 = 62, A5 = 1,480



Technical data

Nominal output kvar	Stage power kvar	Control ratio	Type	Width in mm	Weight in kg	Item no.
60	10/20/30	1:2:3	JF525/60ER6ES8206FK14**	800	317	50.93.040
75	12.5/12.5/25/25	1:1:2:2	JF525/75ER6ES8206FK14**	800	318	50.93.080
100	25/25/50	1:1:2	JF525/100ER4ES8206FK14**	800	368	50.93.120
100	12.5/12.5/25/50	1:1:2:4	JF525/100ER8ES8206FK14**	800	380	50.93.200
120	20/20/40/40	1:1:2:2	JF525/120ER6ES8206FK14**	800	379	50.93.320
150	25/25/50/50	1:1:2:2	JF525/150ER6ES8206FK14**	800	375	50.93.400
175	25/50/50/50	1:2:2:2	JF525/175ER7ES8206FK14**	800	407	50.93.440
200	50	1:1:1:1	JF525/200ER4ES8206FK14**	800	420	50.93.480
200	25/25/50...	1:1:2...	JF525/200ER8ES8206FK14**	800	421	50.93.520
200	12.5/12.5/25/50...	1:1:2:4...	JF525/200ER16ES8206FK14**	800	371	50.93.560
250	50	1:1:1...	JF525/250/ER5ES8206FK14**	800	478	50.93.600
250	25/25/50...	1:1:2...	JF525/250ER10ES8206FK14**	800	490	50.93.640
300	50	1:1:1...	JF525/300ER6ES8206FK14**	800	500	50.93.685
300	25/25/50...	1:1:2...	JF525/300ER12ES8206FK14***	800	500	50.93.690
350	50...	1:1:1...	JF525/350ER7ES8206FK14-S***	800	550	50.93.720
350	50...	1:1:1...	JF525/350ER7ES8206FK14***	1,600	424/365	50.93.722
400	50...	1:1:1...	JF525/400ER8ES8206FK14-S***	800	600	50.93.740
400	50...	1:1:1...	JF525/400ER8ES8206FK14***	1,600	2x424	50.93.742
450	50...	1:1:1...	JF525/450ER9ES8206FK14***	1,600	2x478	50.93.770
500	50...	1:1:1...	JF525/500ER10ES8206FK14***	1,600	500/420	50.93.800
550	50...	1:1:1...	JF525/550ER11ES8206FK14***	1,600	500/478	50.93.805
600	50...	1:1:1...	JF525/600ER12ES8206FK14***	1,600	500/500	50.93.920

Accessories

100 mm high socket for easy supply cable connection	SO 100 / 800 / 600	5	50.00.150
200 mm high socket for easy supply cable connection	SO 200 / 800 / 600	10	50.00.151

Other rated voltages, frequencies, outputs, reactors, mechanical configurations or variants with circuit breakers on request.

** With Prophi® 6R, *** With Prophi® 12R

De-tuned capacitor modules, extractable design

Main features

- Ready-to-install, de-tuned PFC slide-in modules
- Completely mounted and wired with capacitors, reactors, contactors and HRC-fuses
- For slide-in installation in existing PFC or switchgear cabinets
- Nominal voltage: 400 V, 3-phase, 50 Hz
- Reactors: 7 % (189 Hz) and 14 % (134 Hz)
- Protection class: IP32
- Ventilation: Natural (care must be taken to ensure sufficient ventilation)
- With discharge resistors



Dimension diagrams

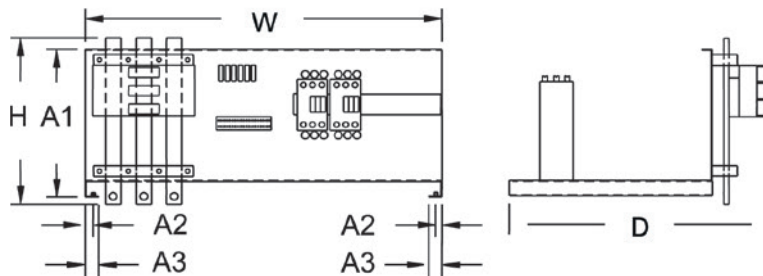

Dimensions in mm:

H = 330, W = 703, D = 533

A1 = 290, A2 = 14, A3 = 26.5



Technical data

7 % de-tuned capacitor modules (189 Hz) MO86FK7 (width 800 mm, depth 600 mm)					
Nominal output kvar	Stage power kvar	Control ratio	Type	Weight in kg	Item no.
10	10		JF440/10EK1MO86FK7	24	50.88.650
12.5	12.5		JF440/12.5EK1MO86FK7	26	50.88.680
20	20		JF440/20EK1MO86FK7	33	50.88.710
25	25		JF440/25/EK1MO86FK7	33	50.88.740
40	40		JF440/40EK1MO86FK7	43	50.88.770
50	50		JF440/50EK1MO86FK7	45	50.88.800
20/2	10	1:1	JF440/20/2EK2MO86FK7	36	50.88.801
25/2	12.5	1:1	JF440/25/2EK2MO86FK7	38	50.88.830
30/2	10/20	1:2	JF440/30/2EK2MO86FK7	42	50.88.860
40/2	20	1:1	JF440/40/2EK2MO86FK7	55	50.88.890
40/3	10/10/20	1:1:2	JF440/40/3EK2MO86FK7	55	50.88.891
50/2	25	1:1	JF440/50/2EK2MO86FK7	56	50.88.930
75/2	25/50	1:2	JF440/75/2EK2MO86FK7	72	50.88.932
80/2	40	1:1	JF440/80/2EK2MO86FK7	72	50.88.933
100/2	50	1:1	JF440/100/2EK2MO86FK7	86	50.88.931

Other rated voltages, frequencies, outputs, reactors, mechanical configurations (e.g. 500 mm switch cabinet depth) or variants with circuit breakers on request. Accessories, see page 273.

14 % de-tuned capacitor modules (134 Hz) MO86FK14 (width 800 mm, depth 600 mm)					
Nominal output kvar	Stage power kvar	Control ratio	Type	Weight in kg	Item no.
10	10		JF525/10EK1MO86FK14	34	50.92.650
12.5	12.5		JF525/12.5EK1MO86FK14	35	50.92.680
20	20		JF525/20EK1MO86FK14	40	50.92.710
25	25		JF525/25EK1MO86FK14	40	50.92.740
40	40		JF525/40EK1MO86FK14	52	50.92.770
50	50		JF525/50EK1MO86FK14	54	50.92.800
20/2	10	1:1	JF525/20/2E2MO86FK14	53	50.92.803
25/2	12.5	1:1	JF525/25/2EK2MO86FK14	60	50.92.804
30/2	10/20	1:2	JF525/30/2EK2MO86FK14	45	50.92.849
40/2	20	1:1	JF525/40/2EK2MO86FK14	67	50.92.850
40/3	10/10/20	1:1:2	JF525/40/3EK3MO86FK14	72	50.92.851
50/2	25	1:1	JF525/50/2EK2MO86FK14	69	50.92.890
75/2	25/50	1:2	JF525/75/2EK2MO86FK14	78	50.92.893
80/2	40	1:1	JF525/80/2EK2MO86FK14	78	50.92.896
100/2	50	1:1	JF525/100/2EK2MO86FK14	92	50.92.892

Other rated voltages, frequencies, outputs, reactors, mechanical configurations or variants (e.g. 500 mm switch cabinet depth) with circuit breakers on request. Accessories, see page 273.

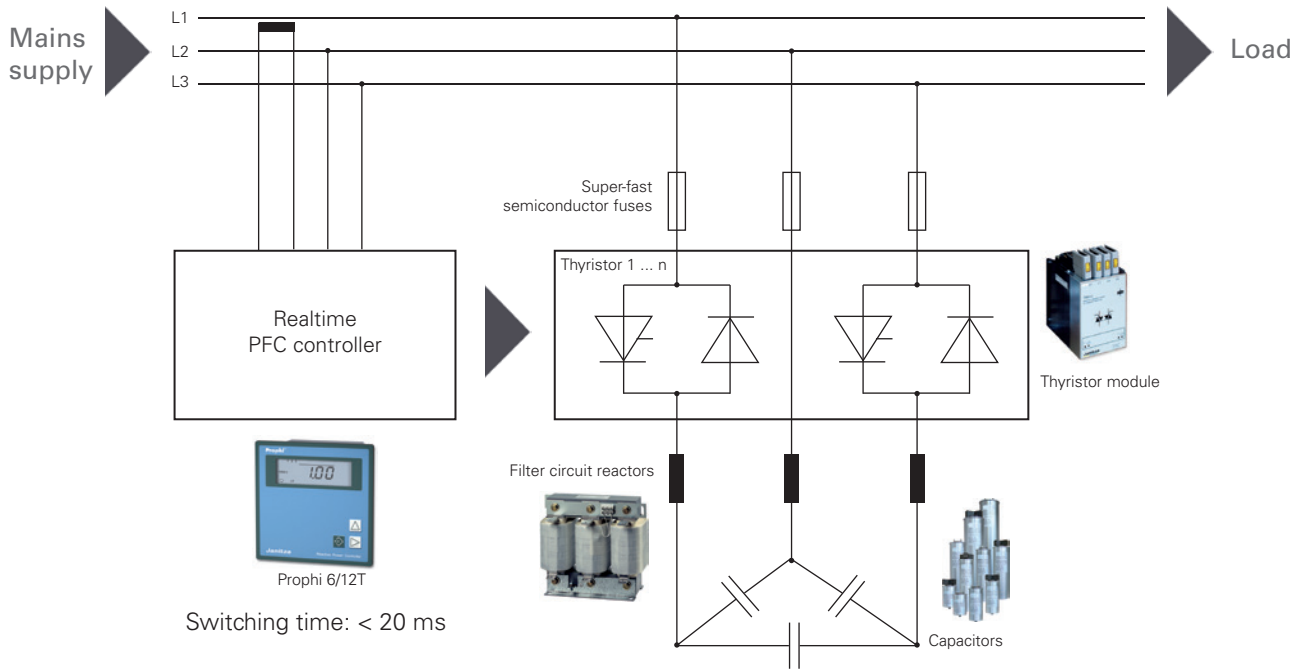

Dynamic power factor correction systems (real time PFC)

Optimised,
thermal design



De-tuned version



Long service life



Minimised
grid distortion



Dynamic power factor correction systems (real time PFC)

Hardly any mains supply distortion

- Switching at zero point transition
- No inrush currents
- Stabilisation of the mains supply voltage
- Reduction of harmonics distortion
- Switching times < 20 ms

Long service life

- Generous space- / power-ratio
- Generously dimensioned cooling system
- High quality capacitors and filter circuit reactors

High operational reliability

- Capacitors with fivefold safety
- PFC controller with 8-way alarm message
- Filter circuit reactors with high linearity and 100% duty cycle
- Optimised thermal design
- Exclusive use of quality components
- Thyristor switch for capacitor connection without mains supply distortion



Areas of application

- Use in applications with fast and high load changes
- APFC in LVDB
- For use in mains supply with harmonics burden
- Converter power (non-linear loads) > 15 % of the connection power
- Total harmonic distortion of THD-U > 3 %
- Harmonics filtering and improvement of power quality
- Reduction in reactive current costs
- Stabilisation of the mains supply voltage

Typical applications

- Automotive industry (welding systems, presses, etc.)
- Lift systems and cranes
- Start-up compensation for large motors
- Drilling rigs in oil production
- Wind turbines
- Welding technology
- Steel production
- Plastic injection moulding systems
- Fishing vessels

Particular advantages

- Improved power quality, i.e. avoidance of high start-up currents for the power capacitors
- Significant extending the service life for the PFC system
- Safety of the complete system is significantly increased (i.e. avoidance of damages through defective contactors and subsequent exploding capacitors)
- Ultra-fast compensation of power factor, resulting in a reduction in the reactive current costs and kWh losses
- Voltage stabilisation (e.g. contactors support during the start-up phase of large motors)
- Improved utilisation of the energy distribution (transformers, cabling, switchgear, etc.) through the elimination of power peaks
- Shortening of process times (e.g. welding) due to stabilized voltage

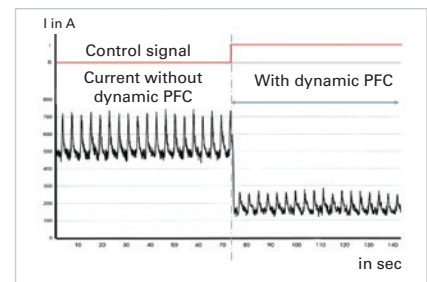

Fig.: Current reduction by means of dynamic PFC

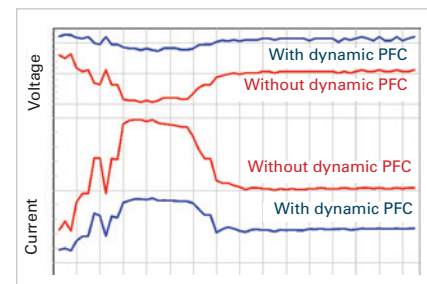

Fig.: Comparison of current and voltage with and without dynamic PFC when starting up a large motor



Device overview and technical data

Dynamic power factor correction				
Technical data				
Standards	DIN, VDE 0660 part 500, EN 60439-1 and EN 60831-1/2			
Design in accordance with	DIN EN 60439 part 1, partial type-approved combination			
Construction type	Sheet steel cabinet for versions KB and ES, module for version MO			
Dynamic power factor controller	Prophi®T version per datasheet or selection table			
Power capacitors	High quality, self-healing, polypropylene 3-phase capacitors using dry technology			
Filter circuit reactors	Low-loss 3-phase reactors with high linearity, 7%, 14% (other reactor ratings on request)			
Electronic switch (t < 20 ms)	Thyristor actuator for switching in the zero point transition (to avoid network disturbances)			
Capacitor protection	Ultra-fast electronic fuses			
Nominal voltage	400 V, 50 Hz (other voltages on request)			
Control voltage	230 V, 50 Hz (other voltages on request)			
Output range	10 – 600 kvar (alternative staging, outputs on request)			
Capacitor nominal voltage	440 V with out reactors and 5.67 – 7 % (choked), 525 V with 14 % (reactors)			
Voltage withstand capability of capacitors	At p = 5.67 – 7 %	440 V	At p = 14 %	525 V
	8 h daily	484 V		577 V
	30 min daily	506 V		604 V
	5 min	528 V		630 V
	1 min	572 V		682 V
Power dissipation	Capacitors < 0.5 W/kvar, systems 4 – 7 W/kvar			
System design	Permissible harmonics currents		Harmonics voltage	
	I 250 Hz	I 350 Hz	U 250 Hz	U 350 Hz
FK 5.67	0.565 IN	0.186 IN	5 %	5 %
FK 7	0.31 IN	0.134 IN	5 %	5 %
FK 14	0.086 IN	0.051 IN	5 %	5 %
Current transformer connection	... /1 A, .../5 A			
Control ratio	See overview of variants			
Discharging	With discharge resistors per EN 60831-1/2			
Maximum altitude	Up to 2,000 m above sea level			
Ambient temperature	35 °C per DIN EN 60439 part 1 (temperature class of the capacitors should be assured with adequate ventilation/cooling at the place of installation!)			
Protection class	Cabinet version = IP32 / Slide-in module = IP00			
Type of cooling	Forced ventilation (except slide-in modules)			
Colour	Grey, RAL 7035			
Noise emission (FK)	< 60 dB with closed systems at 1 m distance			
Connection cross-section and fuse	See technical annex			

The following reactors can be used in mains supply with ripple control systems:		
Mains supply ripple control frequency	De-tuning factor	Filter series resonant frequency
< 168 Hz	p = 14 %	fr = 134 Hz
168 – 183 Hz	p = 14 / 5.67 %	fr = 134 / 210 Hz
> = 216.67	p = 8 %	fr = 177 Hz
> 228 Hz	p = 7 %	fr = 189 Hz
> 350 Hz	p = 5.67 %	fr = 210 Hz

7 % de-tuned dynamic power factor correction, extractable design ES8206 FKTh

Main features

- Dynamic ($t < 20$ ms), de-tuned APFC in extractable design in steel cabinet
- Modular cabinet for free-standing mounting (expandable in output)
- Nominal voltage: 400 V, 3-phase, 50 Hz
- Reactors: 7 % (189 Hz series resonant frequency)
- Protection class: IP32
- Ventilation: From 120 kvar with fan in PFC cabinet door for forced cooling
- With power factor controller Prophi® 6T / 12T



Dimension diagrams

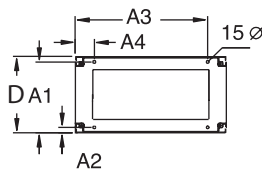

ES8206 (dimensions in mm):
 H = 2,020, W = 800, D = 600, A1 = 537
 A2 = 63, A3 = 737, A4 = 62, A5 = 1,480



Technical data

Nominal output kvar	Stage power kvar	Control ratio	Type	Width in mm	Weight in kg	Item no.
60	10/20/30	1:2:3	JF440/60ER6ES8206FK7Th**	800	290	50.19.040
75	12.5/12.5/25/25	1:1:2:2	JF440/75ER6ES8206FK7Th**	800	290	50.19.080
100	25/25/50	1:1:2	JF440/100ER4ES8206FK7Th**	800	306	50.19.120
120	20/20/40/40	1:1:2:2	JF440/120/ER6ES8206FK7Th**	800	306	50.19.320
100	12.5/12.5/25/50	1:1:2:4	JF440/100ER8ES8206FK7Th**	800	380	50.19.200
125	12.5/25/37.5/50	1:2:3:4	JF440/125ER10ES8206FK7Th**	800	390	50.19.325
150	12.5/12.5/25/50...	1:1:2:4...	JF440/150ER12ES8206FK7Th**	800	410	50.19.330
150	25/25/50/50	1:1:2:2	JF440/150ER6ES8206FK7Th**	800	410	50.19.400
175	12.5/25/37.5/50...	1:2:3:4...	JF440/175ERES8206FK7Th**	800	420	50.19.440
200	50/50/50/50	1:1:1:1	JF440/200ER4ES8206FK7Th**	800	430	50.19.480
200	25/25/50...	1:1:2...	JF440/200ER8ES8206FK7Th**	800	430	50.19.520
200	12.5/12.5/25/50...	1:1:2:4...	JF440/200ER16ES8206FK7Th**	800	435	50.19.560
250	50/50...	1:1...	JF440/250ER5ES8206FK7Th**	800	478	50.19.600
250	25/25/50...	1:1:2...	JF440/250ER10ES8206FK7Th**	800	490	50.19.640
250	12.5/12.5/25/50...	1:1:2:4...	JF440/250ER20ES8206FK7Th***	800	495	50.19.645
300	50/50...	1:1...	JF440/300ER6ES8206FK7Th**	800	500	50.19.685
300	25/25/50...	1:1:2...	JF440/300ER12ES8206FK7Th***	800	500	50.19.690
400	50/50...	1:1...	JF440/400ER8ES8206FK7Th***	1,600	2 x 421	50.19.742
500	50/50...	1:1...	JF440/500ER10ES8206FK7Th***	1,600	500 / 421	50.19.800
600	50/50...	1:1...	JF440/600ER12ES8206FK7Th***	1,600	2 x 500	50.19.820

Accessories						
100 mm high socket for easy supply cable connection	SO 100 / 800 / 600			5		50.00.150
200 mm high socket for easy supply cable connection	SO 200 / 800 / 600			10		50.00.151

Other rated voltages, frequencies, outputs, reactors, mechanical configurations or variants with circuit breakers on request.
 ** With Prophi® 6T, *** With Prophi® 12T

14 % de-tuned dynamic power factor correction, extractable design ES8206 Th

Main features

- Dynamic ($t < 20$ ms), de-tuned APFC in extractable design in steel cabinet
- Modular cabinet for free-standing mounting (expandable in output)
- Nominal voltage: 400 V, 3-phase, 50 Hz
- Reactors: 14 % (134 Hz series resonant frequency)
- Protection class: IP32
- Ventilation: From 120 kvar with fan in PFC cabinet door for forced cooling
- With power factor controller Prophi® 6T / 12T



Dimension diagrams

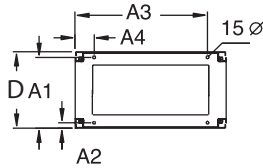

ES8206 (dimensions in mm):
 H = 2,020, W = 800, D = 600, A1 = 537
 A2 = 63, A3 = 737, A4 = 62, A5 = 1,480



Technical data

Nominal output kvar	Stage power kvar	Control ratio	Type	Width in mm	Weight in kg	Item no.
60	10/20/30	1:2:3	JF525/60ER6ES8206FK14Th*	800	290	50.98.040
75	12.5/12.5/25/25	1:1:2:2	JF525/75ER6ES8206FK14Th**	800	290	50.98.080
100	25/25/50	1:1:2	JF525/100ER4ES8206FK14Th**	800	306	50.98.120
120	20/20/40/40	1:1:2:2	JF525/120/ER6ES8206FK14Th**	800	306	50.98.320
100	12.5/12.5/25/50	1:1:2:4	JF525/100ER8ES8206FK14Th**	800	380	50.98.200
125	12.5/25/37.5/50	1:2:3:4	JF525/125ER10ES8206FK14Th**	800	390	50.98.325
150	12.5/12.5/25/50...	1:1:2:4...	JF525/150ER12ES8206FK14Th**	800	410	50.98.330
150	25/25/50/50	1:1:2:2	JF525/150ER6ES8206FK14Th**	800	410	50.98.400
175	12.5/25/37.5/50...	1:2:3:4...	JF525/175ERES8206FK14Th**	800	420	50.98.440
200	50/50/50/50	1:1:1:1	JF525/200ER4ES8206FK14Th**	800	430	50.98.480
200	25/25/50...	1:1:2...	JF525/200ER8ES8206FK14Th**	800	430	50.98.520
200	12.5/12.5/25/50...	1:1:2:4...	JF525/200ER16ES8206FK14Th**	800	435	50.98.560
250	50/50...	1:1...	JF525/250ER5ES8206FK14Th**	800	478	50.98.600
250	25/25/50...	1:1:2...	JF525/250ER10ES8206FK14Th**	800	490	50.98.640
250	12.5/12.5/25/50...	1:1:2:4...	JF525/250ER20ES8206FK14Th***	800	495	50.98.645
300	50/50...	1:1...	JF525/300ER6ES8206FK14Th**	800	500	50.98.685
300	25/25/50...	1:1:2...	JF525/300ER12ES8206FK14Th***	800	500	50.98.690
400	50/50...	1:1...	JF525/400ER8ES8206FK14Th***	1,600	2 x 421	50.98.742
500	50/50...	1:1...	JF525/500ER10ES8206FK14Th***	1,600	500 / 421	50.98.800
600	50/50...	1:1...	JF525/600ER12ES8206FK14Th***	1,600	2 x 500	50.98.920

Accessories			
100 mm high socket for easy supply cable connection	SO 100 / 800 / 600	5	50.00.150
200 mm high socket for easy supply cable connection	SO 200 / 800 / 600	10	50.00.151

Other rated voltages, frequencies, powers, reactors, mechanical configurations or variants with circuit breakers on request.
 ** With Prophi® 6R, *** With Prophi® 12R

De-tuned, dynamic PFC modules extractable design

Main features

- Dynamic ($t < 20$ ms), de-tuned APFC in extractable design in steel cabinet
- For installation in existing switch gear or PFC cabinets
- Nominal voltage: 400 V, 3-phase, 50 Hz
- Reactors: 7 % (189 Hz series resonant frequency),
14 % (134 Hz series resonant frequency)
- Protection class: IP32
- Ventilation: Natural cooling
(care must be taken to ensure sufficient ventilation)
- With discharge resistors



Dimension diagrams

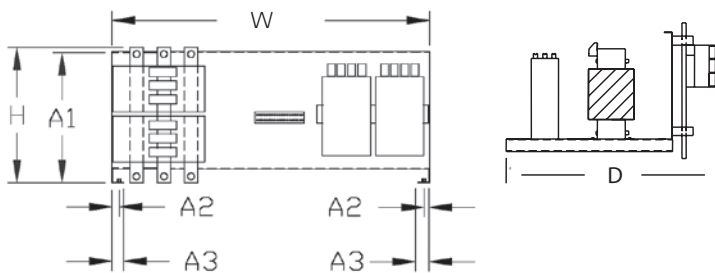

dimensions in mm:

H = 330, W = 703, D = 550

A1 = 290, A2 = 14, A3 = 26.5



Technical data

7 % de-tuned capacitor modules MO86FK7Th (width 800 mm, depth 600 mm)					
Nominal output kvar	Stage power kvar	Control ratio	Type	Weight in kg	Item no.
10	10		JF440/10EK1MO86FK7Th	26	50.18.650
12.5	12.5		JF440/12.5EK1MO86FK7Th	28	50.18.680
20	20		JF440/20EK1MO86FK7Th	35	50.18.710
25	25		JF440/25/EK1MO86FK7Th	35	50.18.740
40	40		JF440/40EK1MO86FK7Th	45	50.18.770
50	50		JF440/50EK1MO86FK7Th	47	50.18.800
20/2	10	1:1	JF440/20/2EK2MO86FK7Th	40	50.18.801
25/2	12.5	1:1	JF440/25/2EK2MO86FK7Th	42	50.18.830
30/2	10/20	1:2	JF440/30/2EK2MO86FK7Th	46	50.18.860
40/2	20	1:1	JF440/40/2EK2MO86FK7Th	57	50.18.890
50/2	25	1:1	JF440/50/2EK2MO86FK7Th	58	50.18.930
75/2	25/50	1:2	JF440/75/2EK2MO86FK7Th	76	50.18.932
80/2	40/40	1:1	JF440/80/2EK2MO86FK7Th	77	50.18.933
100/2	50/50	1:1	JF440/100/2EK2MO86FK7Th	90	50.18.931

14 % de-tuned capacitor modules MO86FK14Th (width 800 mm, depth 600 mm)					
Nominal output kvar	Stage power kvar	Control ratio	Type	Weight in kg	Item no.
10	10		JF525/10EK1MO86FK14Th	36	50.12.650
12.5	12.5		JF525/12.5EK1MO86FK14Th	37	50.12.680
20	20		JF525/20EK1MO86FK14Th	42	50.12.710
25	25		JF525/25EK1MO86FK14Th	43	50.12.740
40	40		JF525/40EK1MO86FK14Th	54	50.12.770
50	50		JF525/50EK1MO86FK14Th	56	50.12.800
20/2	10	1:1	JF525/20/2EK2MO86FK14Th	57	50.12.803
25/2	12.5	1:1	JF525/25/2EK2MO86FK14Th	64	50.12.804
30/2	10/20	1:2	JF525/30/2EK2MO86FK14Th	69	50.12.849
40/2	20	1:1	JF525/40/2EK2MO86FK14Th	71	50.12.850
50/2	25	1:1	JF525/50/2EK2MO86FK14Th	73	50.12.890
75/2	25/50	1:2	JF525/75/2EK2MO86FK14Th	82	50.12.893
80/2	40/40	1:1	JF525/80/2EK2MO86FK14Th	84	50.12.896
100/2	50/50	1:1	JF525/100/2EK2MO86FK14Th	96	50.12.892

Other rated voltages, frequencies, outputs, reactors, mechanical configurations or variants with circuit breakers on request.

Communications architecture: PFC and power quality analysis combined

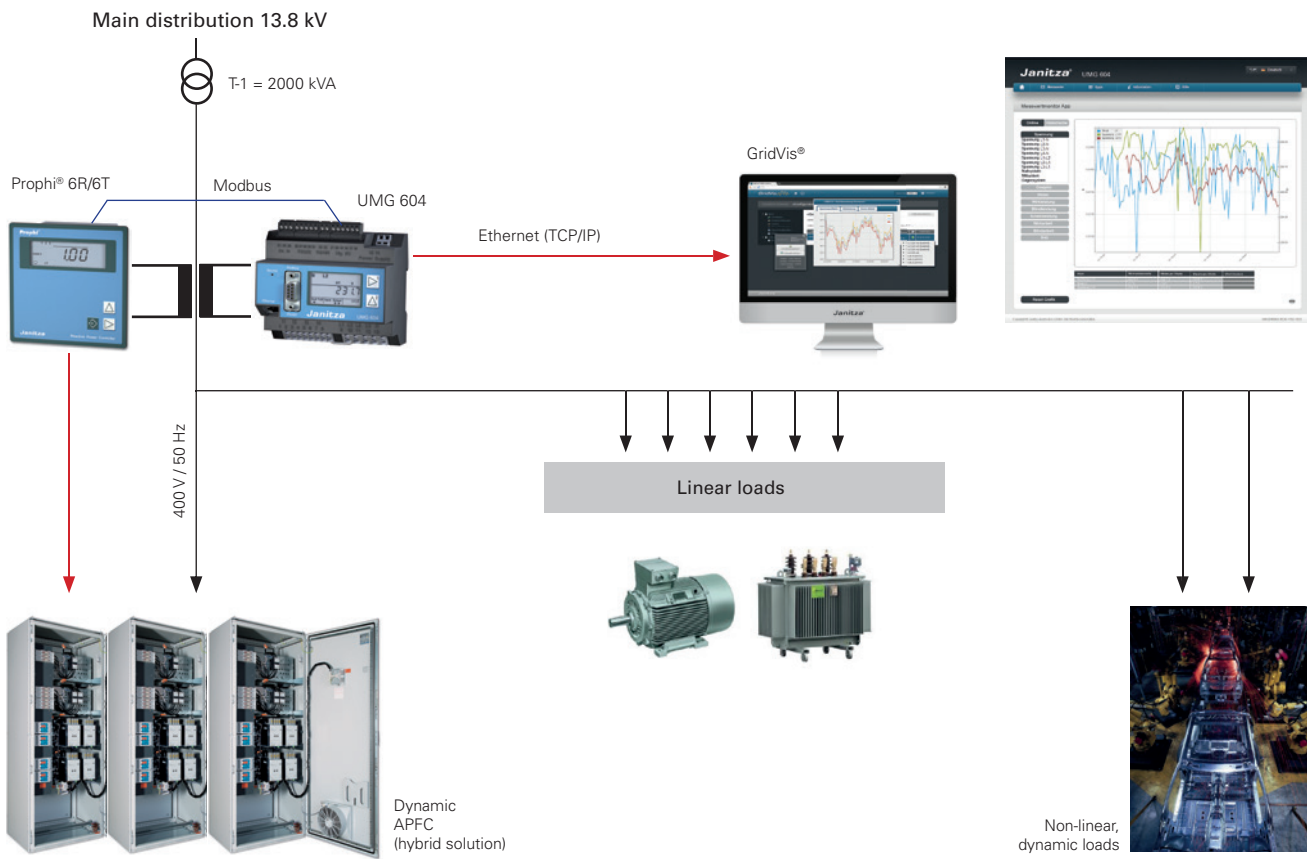

Reactors



Capacitors



Capacitor contactors



HRC fuses



Power factor correction spare parts and accessories

Component selection table for a nominal voltage 400 V – 50 Hz

De-tuned power factor correction							
De-tuning factor %	Reactive output in kvar	Capacitor Item no.	Filter circuit reactors Item no.	Capacitor contactor Item no.	Cable diameter (mm ²)	HRC fuse socket Item no.	HRC fuses Item no.
7	2.50	1 x JCP525 / 4.17-D 19.02.275	FKD 2.50 kvar / 7 % 04.01.500	KS 12.5 kvar / K3-18ND10230 01.02.025	4	NH / RSUmB / Gr00 / 3p 05.03.002	NHS10Gr00 05.05.000
7	5.00	1 x JCP525 / 8.33-D 19.02.249	FKD 5.00 kvar / 7 % 04.01.509	KS 12.5 kvar / K3-18ND10230 01.02.025	4	NH / RSUmB / Gr00 / 3p 05.03.002	NHS10Gr00 05.05.000
7	6.25	1 x JCS525 / 10.0-D 19.02.150	FKD 6.25 kvar / 7 % 04.01.510	KS 12.5 kvar / K3-18ND10230 01.02.025	4	NH / RSUmB / Gr00 / 3p 05.03.002	NHS16Gr00 05.05.001
7	10.00	1 x JCP400 / 9.30-D 19.02.219	FKD 10.0 kvar / 7 % 04.01.501	KS 12.5 kvar / K3-18ND10230 01.02.025	10	NH / RSUmB / Gr00 / 3p 05.03.002	NHS25Gr00 05.05.002
7	12.50	1 x JCP400 / 11.7-D 19.02.221	FKD 12.5 kvar / 7 % 04.01.502	KS 12.5 kvar / K3-18ND10230 01.02.025	10	NH / RSUmB / Gr00 / 3p 05.03.002	NHS25Gr00 05.05.002
7	15.00	1 x JCP400 / 9.30-D 19.02.221 1 x JCP525 / 8.30-D 19.02.249	FKD 15 kvar / 7 % 04.01.512	KS 20.0 kvar / K3-24A00230 01.02.026	10	NH / RSUmB / Gr00 / 3p 05.03.002	NHS35Gr00 05.05.003
7	20.00	2 x JCP400 / 9.30-D 19.02.219	FKD 20.0 kvar / 7 % 04.01.503	KS 20.0 kvar / K3-24A00230 01.02.026	10	NH / RSUmB / Gr00 / 3p 05.03.002	NHS50Gr00 05.05.004
7	25.00	2 x JCP400 / 11.7-D 19.02.221	FKD 25.0 kvar / 7 % 04.01.504	KS 25.0 kvar / K3-32A00230 01.02.027	16	NH / RSUmB / Gr00 / 3p 05.03.002	NHS63Gr00 05.05.005
7	30.00	3 x JCP400 / 9.30-D 19.02.219	FKD 30.0 kvar / 7 % 04.01.505	KS 50.0 kvar / K3-62A00230 01.02.029	35	NH / RSUmB / Gr00 / 3p 05.03.002	NHS63Gr00 05.05.005
7	40.00	3 x JCS440 / 15.0-D 19.02.125	FKD 40.0 kvar / 7 % 04.01.506	KS 50.0 kvar / K3-62A00230 01.02.029	35	NH / RSUmB / Gr00 / 3p 05.03.002	NHS100Gr00 05.05.007
7	50.00	4 x JCP400 / 11.7-D 19.0.2221	FKD 50.0 kvar / 7 % 04.01.507	KS 50.0 kvar / K3-62A00230 01.02.029	50	NH / RSUmB / Gr00 / 3p 05.03.002	NHS125Gr00 05.05.008
14	2.50	1 x JCP525 / 4.17-D 19.02.275	FKD 2.50 kvar / 14 % 04.01.525	KS 12.5 kvar / K3-18ND10230 01.02.025	4	NH / RSUmB / Gr00 / 3p 05.03.002	NHS10Gr00 05.05.000
14	5.00	1 x JCP525 / 7.70-D 19.02.202	FKD 5.00 kvar / 14 % 04.01.526	KS 12.5 kvar / K3-18ND10230 01.02.025	4	NH / RSUmB / Gr00 / 3p 05.03.002	NHS10Gr00 05.05.000
14	6.25	1 x JCP480 / 7.20-D 19.02.210	FKD 6.25 kvar / 14 % 04.01.529	KS 12.5 kvar / K3-18ND10230 01.02.025	4	NH / RSUmB / Gr00 / 3p 05.03.002	NHS16Gr00 05.05.001
14	10.00	1 x JCS525 / 15.0-D 19.02.103	FKD 10.0 kvar / 14 % 04.01.528	KS 12.5 kvar / K3-18ND10230 01.02.025	10	NH / RSUmB / Gr00 / 3p 05.03.002	NHS25Gr00 05.05.002
14	12.50	1 x JCS525 / 12.5-D 19.02.180 1 x JCP525 / 5.90-D 19.02.270	FKD 12.5 kvar / 14 % 04.01.530	KS 12.5 kvar / K3-18ND10230 01.02.025	10	NH / RSUmB / Gr00 / 3p 05.03.002	NHS25Gr00 05.05.002
14	15.00	1 x JCS525 / 12.5-D 19.02.180 1 x JCP525 / 10.0-D 19.02.150	FKD 15 kvar / 14 % 04.01.563	KS 20.0 kvar / K3-24A00230 01.02.026	10	NH / RSUmB / Gr00 / 3p 05.03.002	NHS35Gr00 05.05.003
14	20.00	1 x JCS525 / 12.5-D 19.02.180 1 x JCS525 / 15.0-D 19.02.103	FKD 20.0 kvar / 14 % 04.01.531	KS 25.0 kvar / K3-32A00230 01.02.027	10	NH / RSUmB / Gr00 / 3p 05.03.002	NHS50Gr00 05.05.004
14	25.00	3 x JCS525 / 12.5-D 19.02.180	FKD 25.0 kvar / 14 % 04.01.532	KS 50.0 kvar / K3-62A00230 01.02.029	16	NH / RSUmB / Gr00 / 3p 05.03.002	NHS63Gr00 05.05.005
14	30.00	3 x JCS525 / 15.0-D 19.02.103	FKD 30.0 kvar / 14 % 04.01.561	KS 50.0 kvar / K3-62A00230 01.02.029	35	NH / RSUmB / Gr00 / 3p 05.03.002	NHS63Gr00 05.05.005
14	40.00	1 x JCS525 / 12.5-D 19.02.180 3 x JCS525 / 15.0-D 19.02.103	FKD 40.0 kvar / 14 % 04.01.533	KS 50.0 kvar / K3-62A00230 01.02.029	35	NH / RSUmB / Gr00 / 3p 05.03.002	NHS100Gr00 05.05.007
14	50.00	1 x JCS525 / 12.5-D 19.02.180 4 x JCS525 / 15.0-D 19.02.103	FKD 50.0 kvar / 14 % 04.01.534	KS 50.0 kvar / K3-62A00230 01.02.029	50	NH / RSUmB / Gr00 / 3p 05.03.002	NHS125Gr00 05.05.008

Component selection table for dynamic PFC

Dynamic power factor correction							
De-tuning factor %	Reactive output in kvar	Capacitor Item no.	Filter circuit reactors Item no.	Thyristor actuator Item no.	Cable diameter (mm ²)	HRC fuse socket Item no.	HRC fuses Item no.
7	2.50	1 x JCP525 / 4.17-D 19.02.275	FKD 2.50 kvar / 7 % 04.01.500	TSM-LC10THY 01.02.504	4	NH / RSUmB / Gr00 / 3p 05.03.002	NH00/20A/Ultra Quick 05.05.068
7	5.00	1 x JCP525 / 8.33-D 19.02.249	FKD 5.00 kvar / 7 % 04.01.509	TSM-LC10THY 01.02.504	4	NH / RSUmB / Gr00 / 3p 05.03.002	NH00/20A/Ultra Quick 05.05.068
7	6.25	1 x JCS525 / 10.0-D 19.02.150	FKD 6.25 kvar / 7 % 04.01.510	TSM-LC10THY 01.02.504	4	NH / RSUmB / Gr00 / 3p 05.03.002	NH00/20A/Ultra Quick 05.05.068
7	10.00	1 x JCP400 / 9.30-D 19.02.219	FKD 10.0 kvar / 7 % 04.01.501	TSM-LC10THY 01.02.504	10	NH / RSUmB / Gr00 / 3p 05.03.002	NH00/25A/Ultra Quick 05.05.066
7	12.50	1 x JCP400 / 11.7-D 19.02.221	FKD 12.5 kvar / 7 % 04.01.502	TSM-LC10THY 01.02.504	10	NH / RSUmB / Gr00 / 3p 05.03.002	NH00/25A/Ultra Quick 05.05.066
7	15.00	1 x JCP400 / 9.30-D 19.02.221 1 x JCP525 / 8.30-D 19.02.249	FKD 15 kvar / 7 % 04.01.512	TSM-LC25THY 01.02.505	10	NH / RSUmB / Gr00 / 3p 05.03.002	NH00/50A/Ultra Quick 05.05.065
7	20.00	2 x JCP400 / 9.30-D 19.02.219	FKD 20.0 kvar / 7 % 04.01.503	TSM-LC25THY 01.02.505	10	NH / RSUmB / Gr00 / 3p 05.03.002	NH00/50A/Ultra Quick 05.05.065
7	25.00	2 x JCP400 / 11.7-D 19.02.221	FKD 25.0 kvar / 7 % 04.01.504	TSM-LC25THY 01.02.505	16	NH / RSUmB / Gr00 / 3p 05.03.002	NH00/63A/Ultra Quick 05.05.061
7	30.00	3 x JCP400 / 9.30-D 19.02.219	FKD 30.0 kvar / 7 % 04.01.505	TSM-LC50THY 01.02.503	35	NH / RSUmB / Gr00 / 3p 05.03.002	NH00/63A/Ultra Quick 05.05.061
7	40.00	3 x JCS440 / 15.0-D 19.02.125	FKD 40.0 kvar / 7 % 04.01.506	TSM-LC50THY 01.02.503	35	NH / RSUmB / Gr00 / 3p 05.03.002	NH00/100A/Ultra Quick 05.05.064
7	50.00	4 x JCP400 / 11.7-D 19.02.221	FKD 50.0 kvar / 7 % 04.01.507	TSM-LC50THY 01.02.503	50	NH / RSUmB / Gr00 / 3p 05.03.002	NH00/125A/Ultra Quick 05.05.062
14	2.50	1 x JCP525 / 4.17-D 19.02.275	FKD 2.50 kvar / 14 % 04.01.525	TSM-LC10THY 01.02.504	4	NH / RSUmB / Gr00 / 3p 05.03.002	NH00/20A/Ultra Quick 05.05.068
14	5.00	1 x JCP525 / 7.70-D 19.02.202	FKD 5.00 kvar / 14 % 04.01.526	TSM-LC10THY 01.02.504	4	NH / RSUmB / Gr00 / 3p 05.03.002	NH00/20A/Ultra Quick 05.05.068
14	6.25	1 x JCP480 / 7.20-D 19.02.210	FKD 6.25 kvar / 14 % 04.01.529	TSM-LC10THY 01.02.504	4	NH / RSUmB / Gr00 / 3p 05.03.002	NH00/20A/Ultra Quick 05.05.068
14	10.00	1 x JCS525 / 15.0-D 19.02.103	FKD 10.0 kvar / 14 % 04.01.528	TSM-LC10THY 01.02.504	10	NH / RSUmB / Gr00 / 3p 05.03.002	NH00/25A/Ultra Quick 05.05.066
14	12.50	1 x JCS525 / 12.5-D 19.02.180 1 x JCP525 / 5.90-D 19.02.270	FKD 12.5 kvar / 14 % 04.01.530	TSM-LC10THY 01.02.504	10	NH / RSUmB / Gr00 / 3p 05.03.002	NH00/25A/Ultra Quick 05.05.066
14	15.00	1 x JCS525 / 12.5-D 19.02.180 1 x JCP525 / 10.0-D 19.02.150	FKD 15 kvar / 14 % 04.01.563	TSM-LC25THY 01.02.505	10	NH / RSUmB / Gr00 / 3p 05.03.002	NH00/50A/Ultra Quick 05.05.065
14	20.00	1 x JCS525 / 12.5-D 19.02.180 1 x JCS525 / 15.0-D 19.02.103	FKD 20.0 kvar / 14 % 04.01.531	TSM-LC25THY 01.02.505	10	NH / RSUmB / Gr00 / 3p 05.03.002	NH00/50A/Ultra Quick 05.05.065
14	25.00	3 x JCS525 / 12.5-D 19.02.180	FKD 25.0 kvar / 14 % 04.01.532	TSM-LC25THY 01.02.505	16	NH / RSUmB / Gr00 / 3p 05.03.002	NH00/63A/Ultra Quick 05.05.061
14	30.00	3 x JCS525 / 15.0-D 19.02.103	FKD 30.0 kvar / 14 % 04.01.561	TSM-LC50THY 01.02.503	35	NH / RSUmB / Gr00 / 3p 05.03.002	NH00/63A/Ultra Quick 05.05.061
14	40.00	1 x JCS525 / 12.5-D 19.02.180 3 x JCS525 / 15.0-D 19.02.103	FKD 40.0 kvar / 14 % 04.01.533	TSM-LC50THY 01.02.503	35	NH / RSUmB / Gr00 / 3p 05.03.002	NH00/100A/Ultra Quick 05.05.064
14	50.00	1 x JCS525 / 12.5-D 19.02.180 4 x JCS525 / 15.0-D 19.02.103	FKD 50.0 kvar / 14 % 04.01.534	TSM-LC50THY 01.02.503	50	NH / RSUmB / Gr00 / 3p 05.03.002	NH00/125A/Ultra Quick 05.05.062

PFC-Accessories

Dynamic power factor correction

Thyristor control modules		
Item	Weight in kg	Item no.
Control module with Prophi® 6T controller (for 6 capacitor stages) MCCB, CT terminals and 2 m connection cable (mounted on the capacitor module)	3	50.10.003
Control module with Prophi® 12T controller (for 12 capacitor stages) MCCB, CT terminals and 2 m connection cable (mounted on the capacitor module)	3	50.10.004

Fixing rails		
Item	Weight in kg	Item no.
Set fixing rail, left / right (for Rittal cabinets MO84)	1	50.00.100
Set fixing rail, left / right (for Rittal cabinets MO86)	1.5	50.00.101

Accessory – Passive harmonics filter

Control modules	
Item	Item no.
Control module with Prophi® 6R controller, 6 stages (relay outputs) MCCB, CT terminals and 2 m connection cable (mounted on the capacitor module)	50.80.003
Control module with Prophi® 12R controller, 12 stages (relay outputs) MCCB, CT terminals and 2 m connection cable (mounted on the capacitor module)	50.80.004

Fixing rail for slide-in modules in Rittal switch gear cabinets	
Item	Item no.
Set fixing rail, left / right (for Rittal cabinets MO84)	50.00.100
Set fixing rail, left / right (for Rittal cabinets MO86)	50.00.101

Power analyser with Ethernet connection and PQ analysis software		
Item		Item no.
UMG 508	With display, front panel mounting	52.21.001
UMG 604E	DIN rail mounting	52.16.002



See main catalogue chapter 02 "Energy and power quality measurement products" for other variants

Electronic circuit breaker (thyristor controller)

Main features

- Areas of application: dynamic compensation of rapid processes (presses, welding machines, lifts, power plants, wind turbines, etc.)
- Component for developing dynamic compensation systems
- Optimisation of switching behaviour by microprocessor-controlled adaptation to unchoked or choked capacitor branches
- No wearing parts
- Monitoring of voltage, phase, temperature
- Instant switching
- No mains feedback from switching operations (transients)
- No auxiliary voltage required
- Maintenance-free
- Long service life
- No switching noise
- Improved connection technology (connectors)
- Improved temperature management

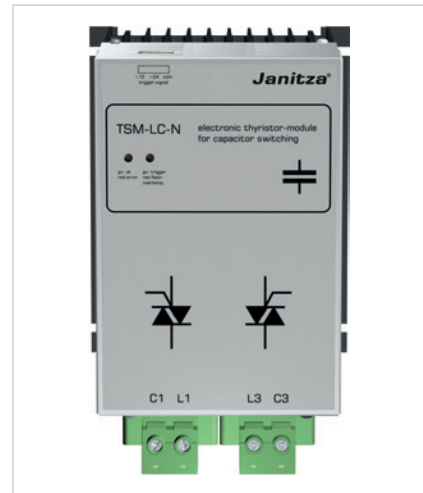

Dimension diagrams

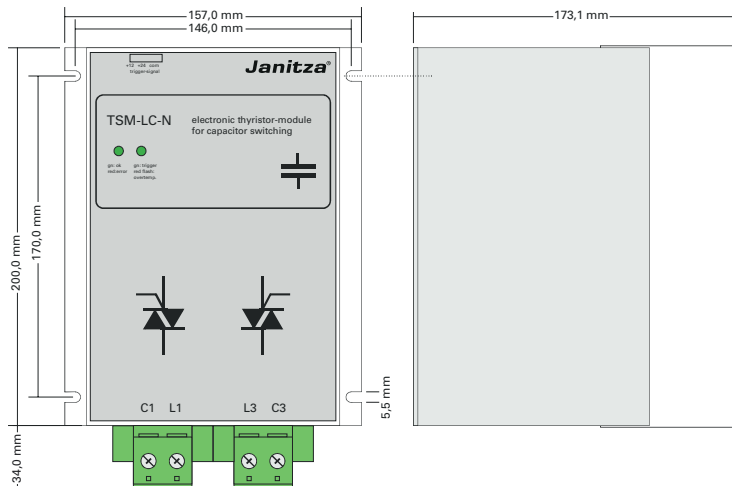

Technical data

Nominal output kvar	Nominal voltage V (50/60 Hz)	Control V DC	Type	Dimensions in mm (W x H x D)	Superfast fuse in A	Weight in kg	Item no.
12,5	400	10 – 24	TSM-LC 10 THY (400 V / 12,5 kvar)	162 x 150 x 75	35	1,75	01.02.504
25	400	10 – 24	TSM-LC-N 25 THY (400 V / bis 25 kvar)	157 x 200 x 173	63	4,80	01.02.516
50	400	10 – 24	TSM-LC-N 50 THY (400 V / bis 50 kvar)	157 x 200 x 173	125	4,80	01.02.515
50 – 85	400 – 690	10 – 24	TSM-LC-N690 THY (690 V / bis 50 kvar)	157 x 200 x 190	125	4,80	01.02.514