

ISOSCAN® EDS440/441

Insulation fault locators for localisation of insulation faults in unearthed DC, AC and three-phase power supply systems (IT systems)

From serial number: 1810...



ISOSCAN® EDS440/441

Insulation fault locators for localisation of insulation faults in unearthed DC, AC and three-phase power supply systems (IT systems)



Insulation fault locator EDS440-L

Device features

- Universal system concept
- Modular design, therefore easily adjustable to the given circumstances
- Measuring current transformers available in various sizes and versions
- CT connection monitoring
- 12 measuring channels for measuring current transformer series W..., WR..., WS...
- Optional extension by 12 relay channels
- Fault memory behaviour selectable
- Up to 50 EDS insulation fault locators in the system, 600 measuring channels
- Response sensitivity:
EDS440 2...10 mA, EDS441 0.2...1 mA
- AC residual current measurement with configurable response value
- Two alarm relays with one N/O contact each
- N/O or N/C operation selectable
- External test/reset
- Central indication of faulty outgoing circuits
- Serial interface RS-485, BS bus address range 2...79
- Connection to higher-level control and visualisation systems possible

Certifications



Product description

The insulation fault locators ISOSCAN® EDS44x are used in connection with the ISOMETER® iso685-D-P or the locating current injector PGH to locate insulation faults in unearthed power supply systems (IT systems).

They detect locating current signals generated by the insulation monitoring device iso685-D-P or IRDH575 or the locating current injector PGH and evaluate them correspondingly. Up to 12 measuring current transformers can be connected to an EDS44x. In total, up to 50 insulation fault locators can be connected via an RS-485 interface (BS bus protocol) and thereby up to 600 outgoing circuits can be monitored.

Application

- Insulation fault location in AC, 3AC and DC IT systems
- Main circuits and control circuits in industrial plants and ships
- Diode-decoupled DC IT systems in power plants
- Systems for medical locations

Function description

When an insulation monitoring device detects the occurrence of an insulation fault, it starts the insulation fault location.

In the event of a first insulation fault, a residual current flows in IT systems that is primarily defined by the system leakage capacitances. The basic idea of the fault location is therefore closing the fault current circuit for a short period of time via a defined resistance. Due to this principle, a locating current, which contains an evaluable signal, is driven through the system voltage.

The locating current is generated by the locating current injector at regular intervals. It is limited in amplitude and time. Thereby, the system conductors are alternately connected to earth via a defined resistance. The resulting locating current depends on the size of the existing insulation fault and the system voltage. It is limited depending on the settings. During project planning it is important to observe that, even in unfavourable cases, there is no system part on which this locating current may cause harmful reactions.

The locating current flows from the locating current injector via the live lines to the insulation fault position taking the shortest way. From there, it flows through the insulation fault and the PE back to the locating current injector. This locating current pulse is detected by the measuring current transformer on the insulation fault path and signalled by the connected insulation fault locator.

Device variants

EDS44...-L

Alarm messages are directly indicated on the device display

EDS44...-S

Alarm messages are displayed on the respective ISOMETER®

Option "W"

Devices with the suffix "W" feature increased shock and vibration resistance. The electronics is covered with a special varnish to provide increased protection against mechanical stress and moisture.

Standards

Observe the applicable national and international standards. The EDS44x series meets the device standards:

- DIN VDE 0100-410 (VDE 0100-410):2007-06
- DIN EN 61557-9 (VDE 0413-9):2015-10
- IEC 61557-9:2014-12
- DIN EN 50155 (VDE 0115-200):2010-11

System variants

The insulation fault locators EDS440 and EDS441 differ depending on their response sensitivity.

The EDS440 is suitable for main circuits. The EDS441 can be used in control circuits and in circuits in medical locations.

	-L	-S	-LAB-4
EDS440	<ul style="list-style-type: none"> • LED • BS bus • $I_{\Delta L} = 2 \dots 10$ mA • Main circuits • Digital inputs and outputs 	<ul style="list-style-type: none"> • No LED • BB bus • $I_{\Delta L} = 2 \dots 10$ mA • Main circuits • No internal voltage supply 	
EDS441	<ul style="list-style-type: none"> • LED • BS bus • $I_{\Delta L} = 0.2 \dots 1$ mA • Control circuits • Digital inputs and outputs 	<ul style="list-style-type: none"> • No LED • BB bus • $I_{\Delta L} = 0.2 \dots 1$ mA • Control circuits • No internal voltage supply 	<ul style="list-style-type: none"> • LED • BS bus • $I_{\Delta L} = 0.2 \dots 1$ mA* • Control circuits • W... AB measuring current transformer • Digital inputs and outputs

* High response sensitivity with large system leakage capacitances.

Operating and display elements EDS44x

EDS440-S

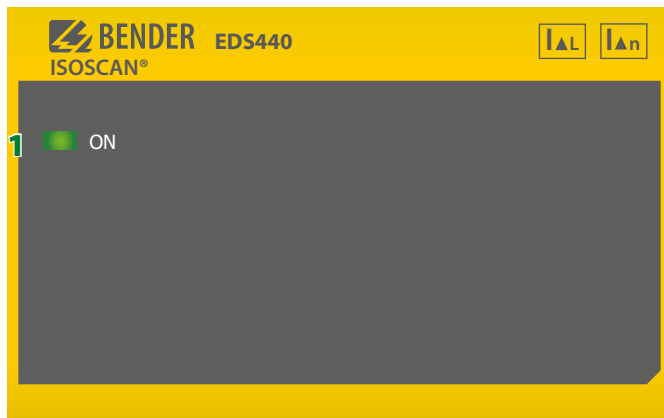

EDS440-L

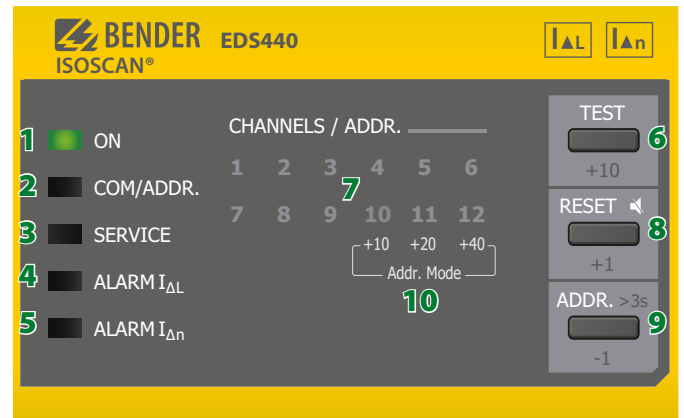

- 1 - The "ON" LED flashes until the device is ready for operation during power up. The "ON" LED lights up when the device is turned on. A current transformer connection test is carried out every hour. During the test, the "ON" LED flashes.
- 2 - The "COM/ADDR." LED flashes quickly while the device communicates via the RS-485 interface. During insulation fault location, the LED flashes to indicate that the locating current injector is sending out a pulse: During the pulse phase, the LED is lit; during the pause, it is not lit. In the LAB procedure, the pulse can last up to one minute. Therefore, no constant "flashing" of the COM LED can be seen. The LED lights up continuously for the pulse time of up to 1 minute.
- 3 - The "SERVICE" LED lights up either when there is a device error, a connection fault of the measuring current transformers or an error message e.g. due to low-frequency residual currents, external magnetic fields, etc.
- 4 - The "ALARM $I_{\Delta L}$ " LED signals the main alarm. The LED lights up when an insulation fault is detected (EDS function) on one of the measuring channels.
- 5 - The "ALARM $I_{\Delta n}$ " LED lights up if the set response value for residual currents is exceeded. The factory setting for the response value is 10 A for the EDS440 and 1 A for the EDS441.

- 6 - The channel LEDs "1"..."12" light up: A channel LED lights up if an insulation fault is detected on the respective measuring channel or if there is a residual current alarm. The channel LEDs "1"..."12" flash: If there is a connection fault of the measuring current transformer, the channel LED flashes slowly (1 Hz). If there is an interference during insulation fault location, the channel LED flashes quickly (2 Hz).
- 7 - Pressing the TEST button triggers the self test of the device. In the address assignment mode, the address can be set in steps of ten. (+10)
- 8 - You can reset the fault memory using the RESET button. The fault memory can only be reset if it is activated and the fault has been eliminated. In the address assignment mode, the address can be set in steps of one. (+1)
- 9 - Pressing the button for 3 seconds activates the address assignment mode. In the address assignment mode, the address can be set in steps of one (+1 and -1) and steps of ten (+10).
- 10 - Addr. Mode: Indication of the present tens counter by means of the channel LEDs 10, 11 and 12.

Connection to the voltage supply

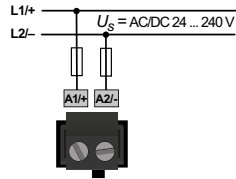
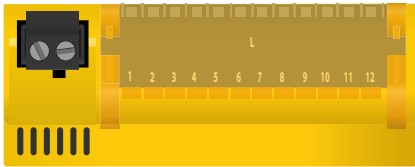

Connection to the X1 interface

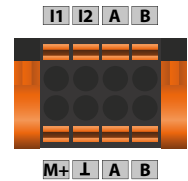
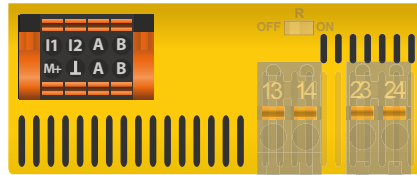

I1	Input 1	M+	Dig. current output
I2	Input 2	L	Ground
A	RS-485 A (input)	A	RS-485 A (output)
B	RS-485 B (input)	B	RS-485 B (output)

Connection of relays

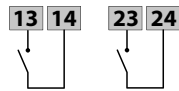
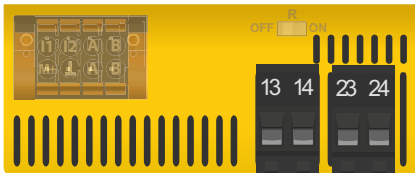

Alarm relay 1	13	N/O contact	Alarm relay 2	23	N/O contact
	14			24	

BS bus termination

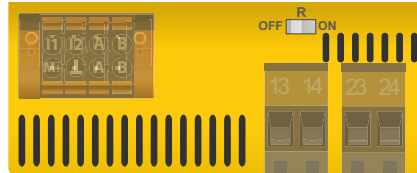

Activating a terminating resistor to define the first and the last device in the bus system.

ON	First and last device in a bus	OFF	All devices between the first and the last device in the bus
----	--------------------------------	-----	--

Connection to the k1-12/I1-12 interface

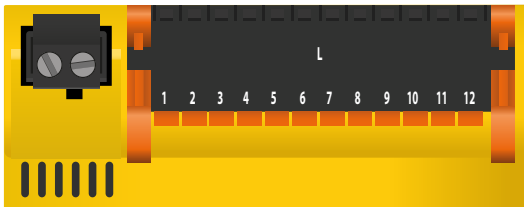

I1	Measuring CT 1	k1
I2	Measuring CT 2	k2
I3	Measuring CT 3	k3
I4	Measuring CT 4	k4
...
I12	Measuring CT 12	k12

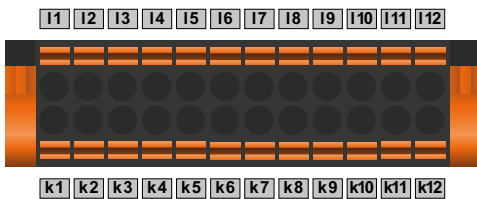

Connection measuring current transformer W..., WR..., WS... series

For insulation fault location, the measuring current transformers of the W... (closed), WR... (rectangular) and WS... (split-core) series are used.

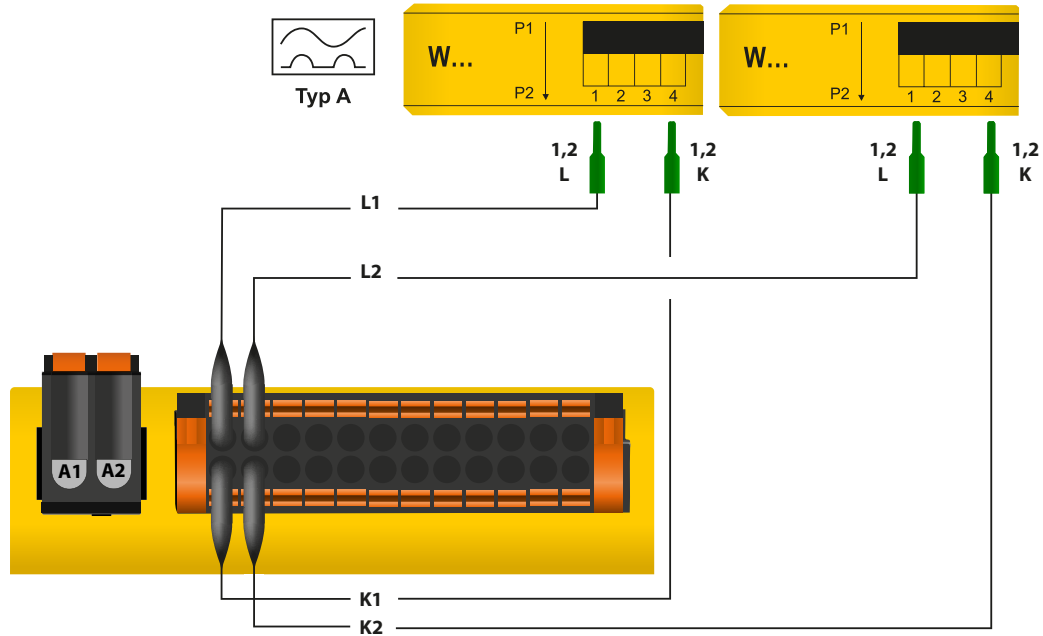

Connecting measuring current transformers of the W...AB series to EDS441-LAB

To use the EDS441-LAB with the maximum locating current of $\leq 1.8 \text{ mA}$, the closed measuring current transformers of the W...AB series are required. For every 6 measuring current transformers of the W...AB series, one power supply unit AN420 or AN110 is required.

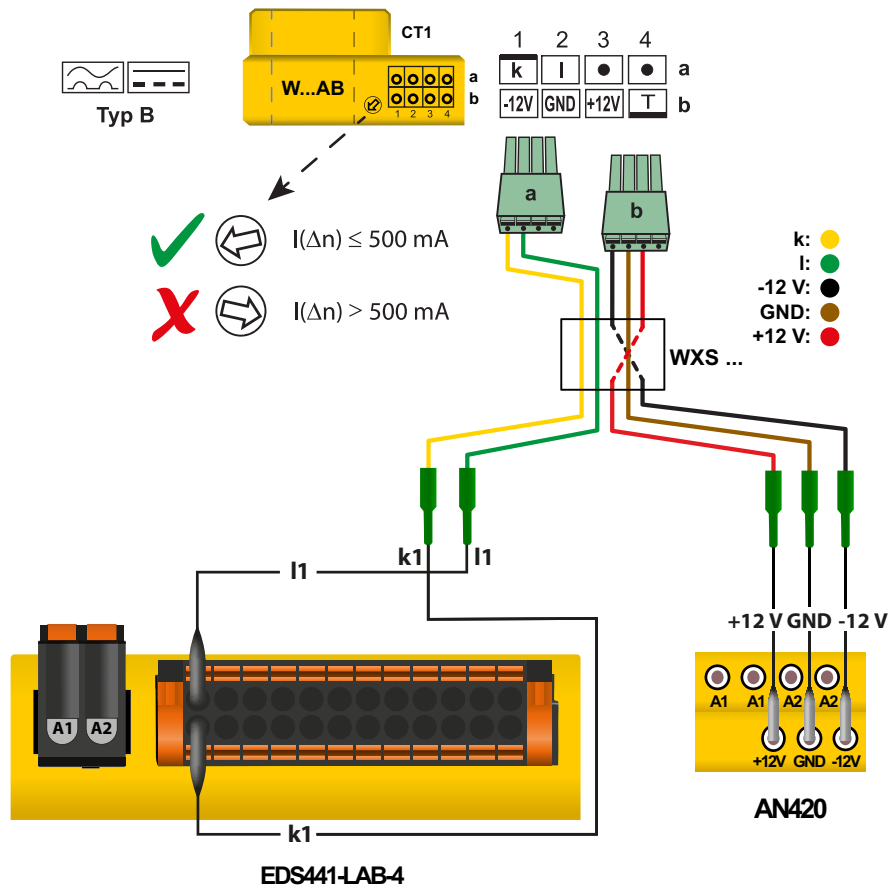

Wiring diagram to 3(N)AC system with iso685-D-P

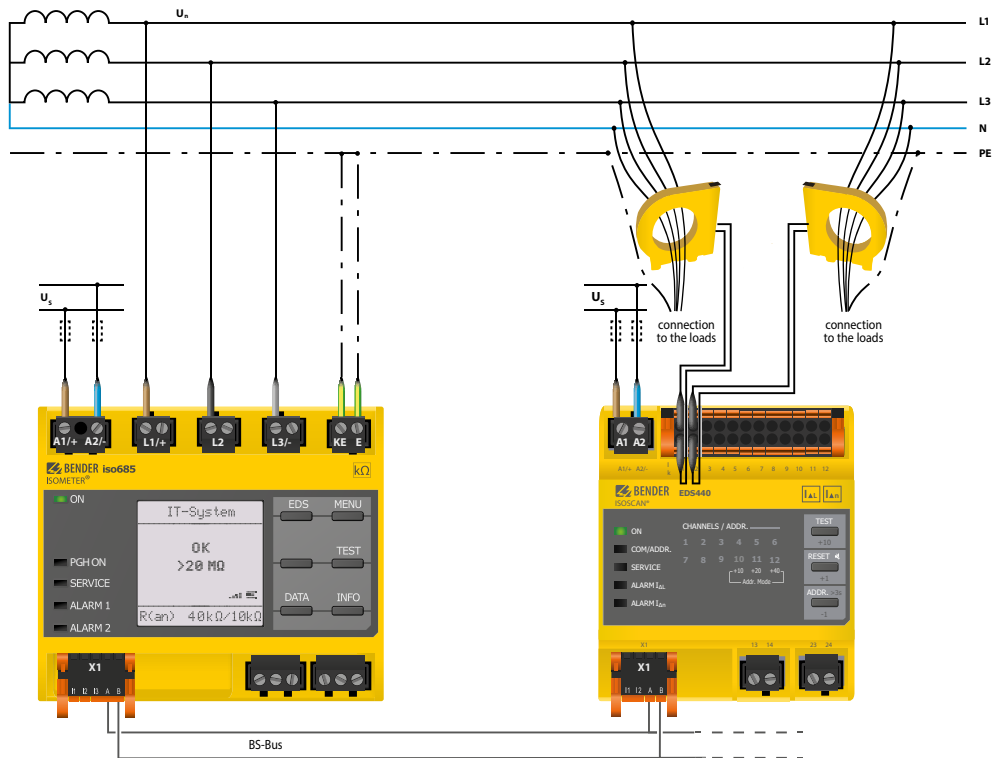

Wiring diagram to DC system with iso685-D-P

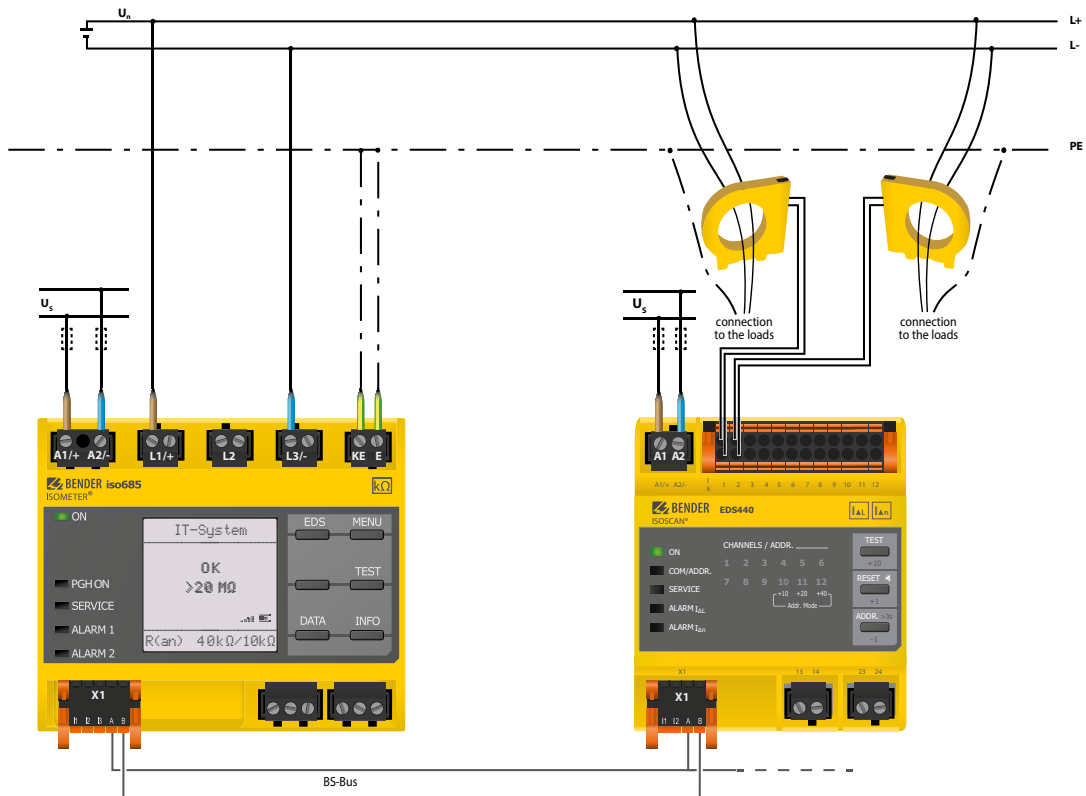

Wiring diagram to AC system with iso685-D-P

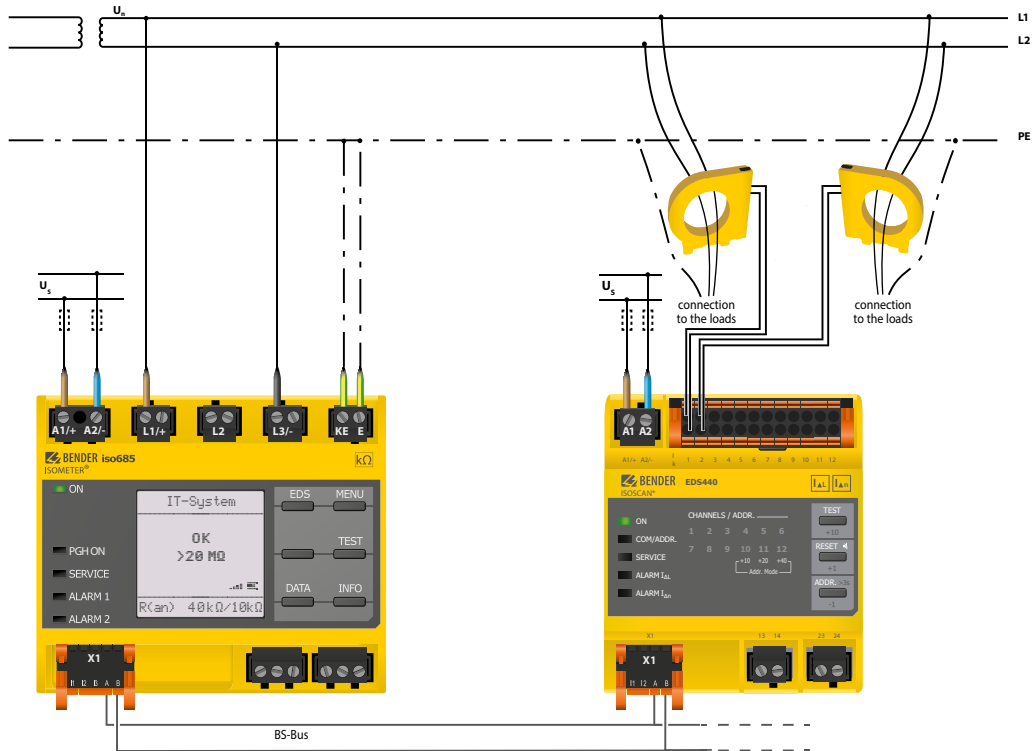

Connection example: iso685-D-P, EDS440-S and EDS440-L

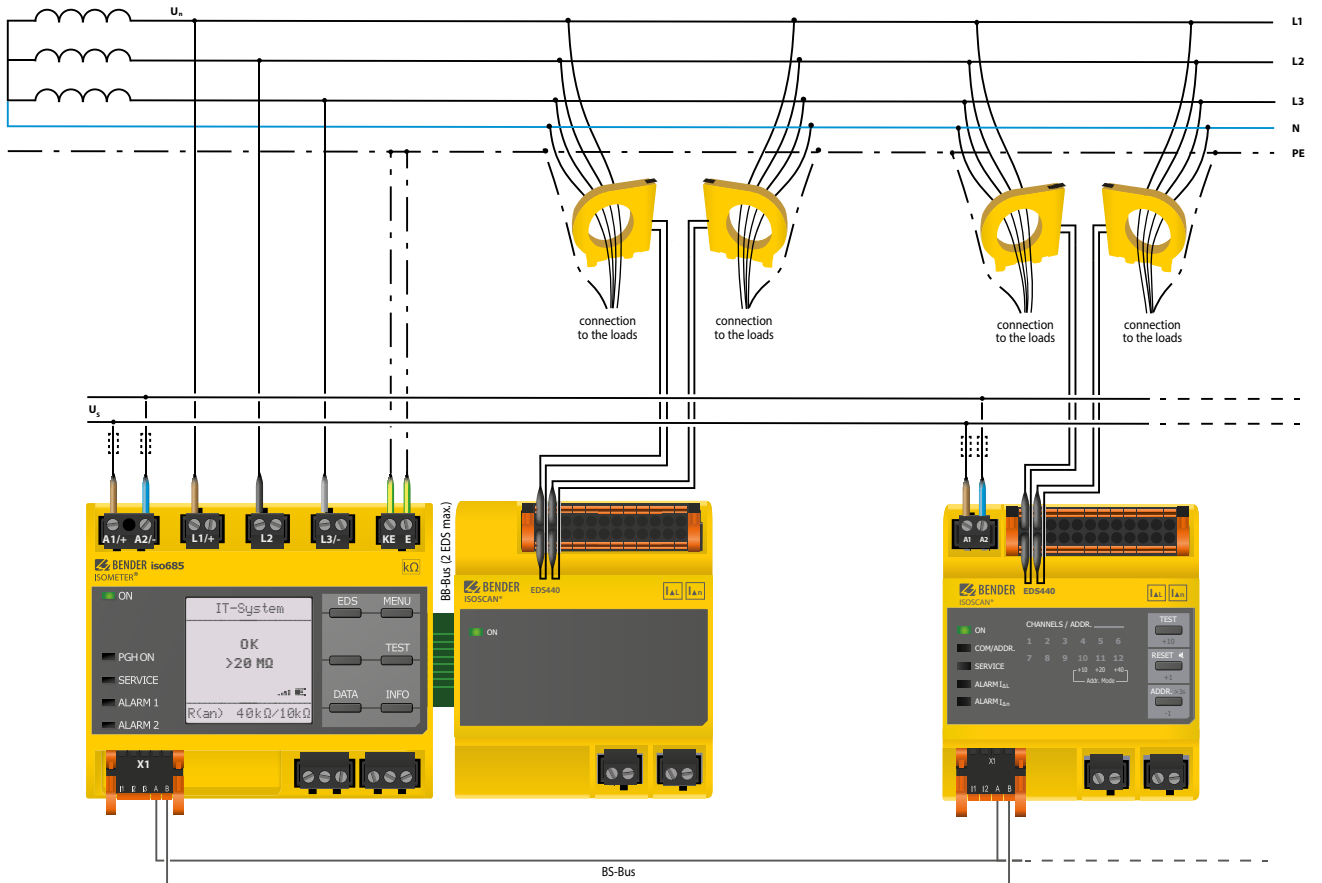

Technical data

Insulation coordination

Rated insulation voltage (IEC 60664-1)	AC 250 V
Rated impulse voltage (IEC 60664-1)	4 kV
Overvoltage category	III
Pollution degree	3
Protective separation (reinforced insulation) between	(A1,A2)-(13,14)-(23,24)-(X1,X2,X3)
Voltage test acc. to IEC 61010-1	2.2 kV

Supply voltage

Supply voltage range U_S	AC/DC 24...240 V
Tolerance of U_S	-20...+15%
Frequency range of U_S	DC, 50...400 Hz ¹⁾²⁾
Tolerance of the frequency range of U_S	-5...+15%
Power consumption, typically 50 Hz (400 Hz) EDS44...L	≤4 W/7 VA (≤4 W, 28 VA)
Power consumption, typically (DC via BB-Bus) EDS44...S	≤1 W

Response values

Response value insulation fault location ($I_{\Delta L}$) EDS440	2...10 mA
Response value insulation fault location ($I_{\Delta L}$) EDS441	0.2...1 mA
Relative uncertainty ($I_{\Delta L}$) EDS440	±30 %, ±2 mA ³⁾
Relative uncertainty ($I_{\Delta L}$) EDS441	±30 %, ±0.2 mA ³⁾
Response value residual current measurement ($I_{\Delta n}$) EDS440	100 mA...10 A
Response value residual current measurement ($I_{\Delta n}$) EDS441	100 mA...1 A
Relative uncertainty ($I_{\Delta n}$) EDS44x (42...60 Hz)	±5 %
Relative uncertainty ($I_{\Delta n}$) EDS44x (61...1000 Hz)	-20...0 %
Hysteresis	20 %

Time response

Scanning time for all channels insulation fault location ($I_{\Delta L}$)	profile-dependent, min. 6 s
Response time residual current measurement ($I_{\Delta n}$)	≤ 400 ms
Response time for measuring current transformer monitoring	max.18 min

Measuring circuit

Nominal system voltage U_n EDS440 refer to locating current injector (e.g. ISOMETER® iso685-D-P)	
Nominal system voltage U_n EDS441	AC 230 V, DC 220 V
Tolerance of U_n EDS441	AC +15 %, DC +40 %
Measuring current transformer external for EDS440 type	W..., WR..., WS...
Measuring current transformer external for EDS441 type	W.../8000, WS.../8000
Measuring current transformer external for EDS44x-LAB type	W...AB
Load EDS440	47 Ω
Load EDS441	1.5 Ω
Rated insulation voltage (measuring current transformer)	800 V

Connection EDS measuring current transformer

Single wire ≥ 0.75 mm ²	0...1 m
Single wire, twisted ≥ 0.75 mm ²	1...10 m
Shielded cable ≥ 0.5 mm ²	10...40 m
Recommended cable (shielded, shield connected to PE on one side)	J-Y (St) Y min. 2x0.8

Measuring ranges insulation fault location $I_{\Delta L}$

Rated frequency range	DC, 16.7...1000 Hz
Measuring range insulation fault location ($I_{\Delta L}$) EDS440	1.5...25 mA
Measuring range insulation fault location ($I_{\Delta L}$) EDS441	0.15...5 mA
Max. residual current	see diagrams in manual

Measuring ranges residual current measurement $I_{\Delta n}$

Measuring range residual current measurement ($I_{\Delta n}$) EDS440	100 mA...20 A
Rated frequency range EDS440	50...1000 Hz
Measuring range residual current measurement ($I_{\Delta n}$) EDS441	100 mA...2 A
Rated frequency range EDS441	50...60 Hz

LEDs

ON (operation LED)	green
COM	yellow
SERVICE	yellow
$I_{\Delta L}$ ALARM	yellow
$I_{\Delta n}$ ALARM	yellow
1...12 channel indication	yellow

Digital inputs

Number	2
Operating mode, adjustable	active high, active low
Function	none, test, reset
Voltage level	Low DC -5...5 V, High DC 11...32 V

Digital current output

Number	1
Function	none, $I_{\Delta L}$ alarm, $I_{\Delta n}$ alarm, device fault, transformer connection fault, common alarm
Current	0 mA DC inactive, 20 mA DC active
Tolerance	±10 %
Burden resistance	$R \leq 500 \Omega / P_R \geq 0,25 W$

Buzzer

Number	1
Function	none, $I_{\Delta L}$ alarm, $I_{\Delta n}$ alarm, device fault, transformer connection fault, insulation fault location active, common alarm

Interfaces

Interface/protocol	RS-485/BS
Data rate	9600 baud/s
Cable length	≤ 1200 m
Cable: twisted pair, one end of shield connected to PE	recommended: J-Y (St) Y min. 2x0.8
Connection	X1.A, X1.B
Terminating resistor	120 Ω, can be connected internally
Device address, BS bus	0, 2...79 (optional 0, 2...159)

Switching elements

Number	2 N/O contacts
Operating mode	N/C operation/N/O operation
Function contact 13,14	none, $I_{\Delta L}$ alarm, $I_{\Delta n}$ alarm, device fault, transformer connection fault, common alarm
Function contact 23,24	none, $I_{\Delta L}$ alarm, $I_{\Delta n}$ alarm, device fault, transformer connection fault, common alarm

Electrical endurance under rated operating conditions	30000
Rated operational voltage	250 VAC
Rated operational current	7 A
Rated insulation voltage	4 kV
Max. switching capacity	300 W/2770 VA
Max. switching capacity	30 VDC/277 VAC

Environment/EMC

EMC	IEC 61326-2-4
-----	---------------

Ambient temperatures:

Operating temperature	-25...+55 °C
Transport	-40...+85 °C
Storage	-25...+70 °C

Classification of climatic conditions acc. to IEC 60721:

Stationary use (IEC 60721-3-3)	3K5 (no condensation, no formation of ice)
Transport (IEC 60721-3-2)	2K3
Long-term storage (IEC 60721-3-1)	1K4

Classification of mechanical conditions acc. to IEC 60721:

Stationary use (IEC 60721-3-3)	3M4
Transport (IEC 60721-3-2)	2M2
Long-term storage (IEC 60721-3-1)	1M3
Range of use	≤ 2000 m above sea level

Technical data (continuation)

Connection

Connection type pluggable screw-type terminal or push-wire terminal

Screw-type terminal:

Tightening torque	0.5...0.6 Nm (5...7 lb-in)
Conductor sizes	AWG 24-12
Stripping length	7 mm
rigid/flexible	0.2...2.5 mm ²
flexible with ferrules, with/without plastic sleeve	0.25...2.5 mm ²
Multiple conductor, rigid	0.2...1 mm ²
Multiple conductor, flexible	0.2...1.5 mm ²
Multiple conductor, flexible with ferrule without plastic sleeve	0.25...1 mm ²
Multiple conductor, flexible with TWIN ferrule with plastic sleeve	0.5...1.5 mm ²

Push-wire terminals:

Conductor sizes	AWG 24-12
Stripping length	10 mm
rigid/flexible	0.2...2.5 mm ²
flexible with ferrules, with/without plastic sleeve	0.25...2.5 mm ²
Multiple conductor, flexible with TWIN ferrule with plastic sleeve	0.5...1.5 mm ²

Push-wire terminals X1, X2:

Conductor sizes	AWG 24-16
Stripping length	10 mm
rigid/flexible	0.2...1.5 mm ²
flexible with ferrule without plastic sleeve	0.25...1.5 mm ²
flexible with TWIN ferrule with plastic sleeve	0.25...0.75 mm ²

Other

Operating mode	continuous operation
Mounting	at an ambient temperature >55 °C vertical mounting required at an ambient temperature <55 °C mounting optional
Degree of protection internal components	IP40
Degree of protection terminals	IP20
DIN rail mounting acc. to	IEC 60715
Screw fixing	2 x M4 with mounting clip
Enclosure material	polycarbonate
Flammability class	UL 94V-0
Dimensions (W x H x D)	72 x 93 x 63
Documentation number	D00201
Weight	approx. 122 g (EDS44x-S) approx. 242 g (EDS44x-L)

Option "W" data different from the standard version

Devices with the suffix „W“ feature increased shock and vibration resistance. The electronics is covered with a special varnish to provide increased protection against mechanical stress and moisture.

Ambient temperatures:

Operating temperature	-40...+70 °C
Transport	-40...+85 °C
Long-term storage	-40...+70 °C

Classification of climatic conditions acc. to IEC 60721:

Stationary use (IEC 60721-3-3) 3K5 (condensation and formation of ice possible)

Classification of mechanical conditions acc. to IEC 60721:

Stationary use (IEC 60721-3-3) 3M7

- ¹⁾ = at a frequency >200 Hz, connection of X1 and k1-12/l1-12 must be insulated. Only permanently installed devices which at least have overvoltage category CAT2 (300V) may be connected.
- ²⁾ = only 50/60 Hz are permitted for UL applications.
- ³⁾ = effect of a residual current >100 mA results in a greater relative uncertainty.

Dimension diagram

Dimensions in mm

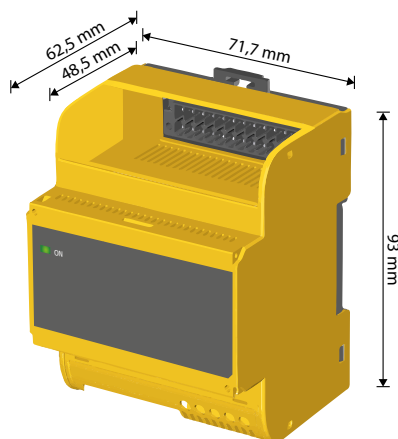

Ordering information

Supply voltage U_s ¹⁾	Response value	LED display	Option "W"	Type	Art. no.	
			-40...+70 °C, 3K5, 3M7			
AC/DC 24...240V	2...10 mA	-	-	EDS440-S-1	B91080201	
			■	EDS440W-S-1	B91080201W	
		■	-	EDS440-L-4	B91080202	
			■	EDS440W-L-4	B91080202W	
	0.2...1 mA	-	-	-	EDS441-S-1	B91080204
				■	EDS441W-S-1	B91080204W
			■	-	EDS441-L-4	B91080205
				■	EDS441W-L-4	B91080205W
		■	-	-	EDS441-LAB-4	B91080207
				■	EDS441W-LAB-4	B91080207W

¹⁾ Absolute values

Suitable system components

Supply voltage U_s	Type	Art. no.
AC/DC 24 V ± 20 %	DI-1PSM (RS-485 repeater)	B95012044
Supplied by USB interface	DI-2USB (interface converter RS-485/USB) with USB cable	B95012045
12-fold relay module	IOM441-S (input/output module)	B95012057
AC, 100...250 V 50/60 Hz, DC ±12 V DC, 100...250 V, DC ±12 V	AN420 (power supply unit for W...AB current transformers)	B74053100 B94053100
AC 230 V, 50/60 Hz AC, DC 20 V	AN471 (power supply unit for DI-1 or DI-2)	B924189
-	Snap-on mounting W20.../35...	B98080501
-	Snap-on mounting W60...	B98080502

Accessories

Description	Art. no.
Plug kit, screw terminals ¹⁾	B91080901
Plug kit, push-wire terminals	B91080902
Mechanical accessories (terminal cover, 2 mounting clips) ¹⁾	B91080903
BB bus 4TE Connector ²⁾	B98110002

¹⁾ included in the scope of delivery

²⁾ included in the scope of delivery of EDS44x-S-4

Measuring current transformer for EDS440

Design type	Internal diameter/mm	Type	Art. no.
circular	20	W20	B98080003
	35	W35	B98080010
	60	W60	B98080018
	120	W120	B98080028
	210	W210	B98080034
split-core	20 x 30	WS20x30	B98080601
	50 x 80	WS50x80	B98080603
	80 x 120	WS80x120	B98080606

Alternative measuring current transformer from the Bender program

Design type	Internal diameter/mm	Type	Art. no.	
circular	10	W10/600	B911761	
	20	W0-S20	B911787	
	35	W1-S35	B911731	
	70	W2-S70	B911732	
	105	W3-S105	B911733	
	140	W4-S140	B911734	
	210	W5-S210	B911735	
	rectangular	70x175	WR 70x175S	B911738
		115x305	WR 115x305S	B911739
		150x350	WR 150x350S	B911740
200x500		WR 200x500S	B911763	
split-core	50x80	WS 50x80S	B911741	
	80x80	WS 80x80S	B911742	
	80x120	WS 80x120S	B911743	
	80x160	WS 80x160S	B911755	

For further information regarding the measuring current transformers, refer to the respective data sheets.

Measuring current transformer for EDS441

Design type	Internal diameter/mm	Type	Art. no.
circular	20	W20-8000	B98080009
	35	W35-8000	B98080017
	60	W60-8000	B98080027
split-core	20 x 30	WS20x30-8000	B98080602
	50 x 80	WS50x80-8000	B98080604

Measuring current transformer for EDS441-LAB

Design type	Internal diameter/mm	Type	Art. no.
circular	20	W20AB	B98080008
	35	W35AB	B98080016
	60	W60AB	B98080026
	120	W120AB	B98080041
	210	W210AB	B98080040

Alternative measuring current transformer from the Bender program

Design type	Internal diameter/mm	Type	Art. no.
circular	10	W10/8000	B911759
	35	W1-35/8000	B911756
circular, 6-fold	10	W10/8000-6	B911900
split-core	20 x 30	WS20x30/8000	B911764
	50 x 80	WS50x80/8000	B911757

For further information regarding the measuring current transformers, refer to the respective data sheets.

Characteristic curve for response sensitivity

Network configuration, mains voltage, mains frequency, leakage capacitance and test current influence the responsiveness of the EDS system.

The resulting insulation resistance response value R_{an} is determined step by step using the formulas and diagrams.

- Evaluation of system types 3AC, AC or DC
 - 3AC or AC system: $U_n = 0.6 U_n$
 - DC system: $U_n = 1.0 U_n$
- Calculate the standardised response value $R_{an}(C_e = 0 \mu F)$ with an assumed leakage capacitance of $C_e = 0 \mu F$ and the EDS response value $I_{an} = 5 \text{ mA}$: $R_{an}(C_e = 0 \mu F) = U_n / I_{an}$

- Extract correction factor K from the diagram by forming the product with evaluated U_n and real leakage capacitance C_e .
- Calculate real response value:
 $R_{an} = K \times R_{an}(C_e = 0 \mu F)$

Example for a system with AC 230 V:

- to 1) = 138 V
- to 2) at 5 mA = 27.6 kΩ
- to 3) at 10 μF = 0.8
- to 4) = 22 kΩ

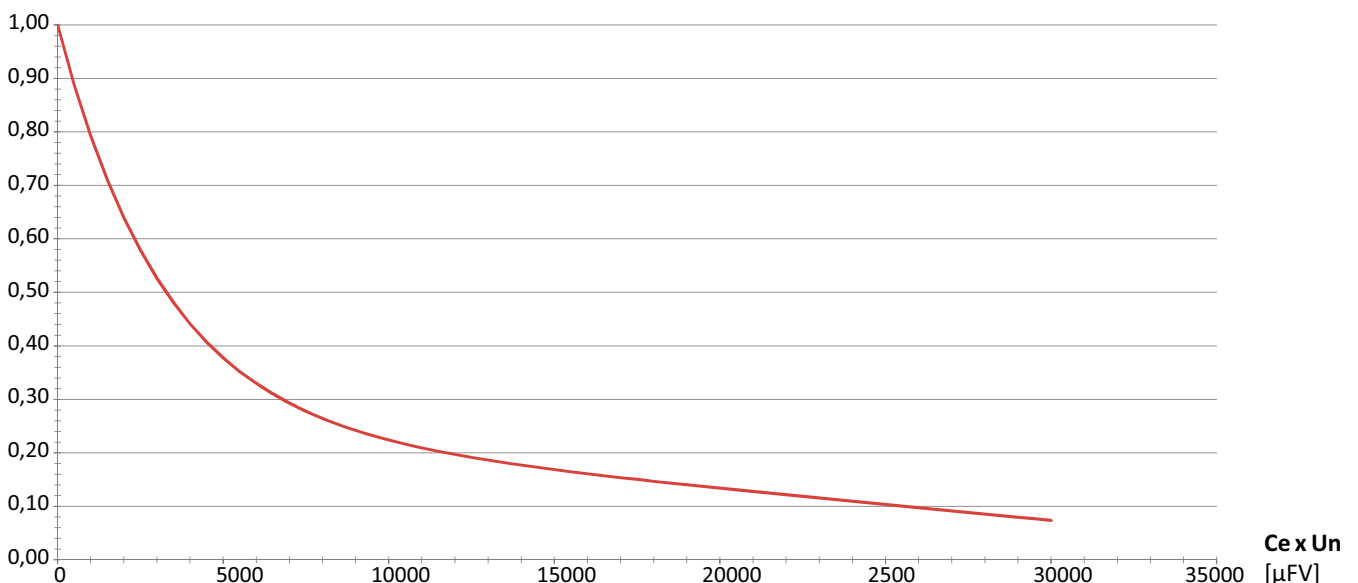

Fault curve EDS440.../EDS441...

An insulation fault location beyond the grey area causes an error message. The EDS44...-L indicates error messages via flashing LEDs. Use an EDS44...-S, then the fault messages are indicated via the ISOMETER®.

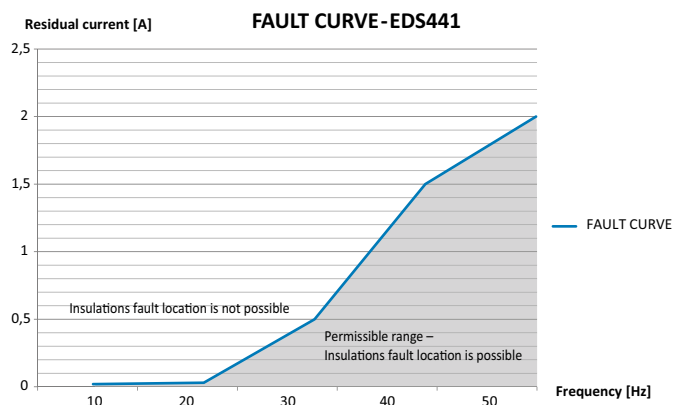
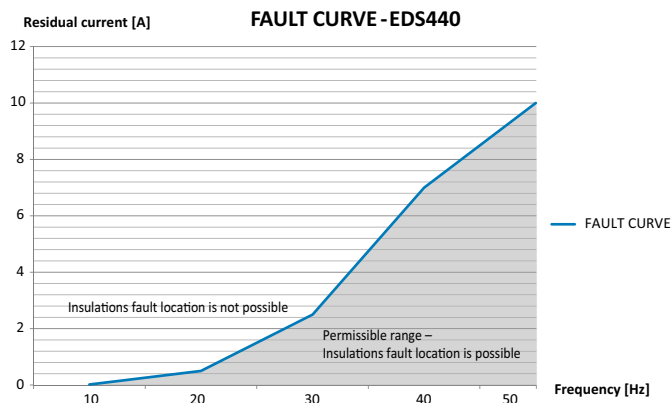

optec

energie ist messbar

Optec AG | Guyer-Zeller-Strasse 14 | CH-8620 Wetzikon ZH

Telefon: +41 44 933 07 70 | Telefax: +41 44 933 07 77

E-Mail: info@optec.ch | Internet: www.optec.ch



BENDER

The Power in Electrical Safety®

Bender GmbH & Co. KG

P.O. Box 1161 • 35301 Gruenberg • Germany

Londorfer Straße 65 • 35305 Gruenberg • Germany

Tel.: +49 6401 807-0 • Fax: +49 6401 807-259

E-Mail: info@bender.de • www.bender.de



BENDER Group