



# EDS460/490 and EDS461/491



## Insulation fault locator

**Software version: EDS4.0-D: D234 V3.1 / D256 V2.2**

**EDS4.0-L: D234 V3.1 / D216 V2.2**

**EDS4.1-D: D358 V3.1 / D256 V2.2**

**EDS4.1-L: D358 V3.1 / D216 V2.2**



**Bender GmbH & Co. KG**

Londorfer Str. 65 • 35305 Gruenberg • Germany  
Postfach 1161 • 35301 Gruenberg • Germany

Tel.: +49 6401 807-0

Fax: +49 6401 807-259

E-Mail: [info@bender.de](mailto:info@bender.de)

Web: <http://www.bender.de>

© Bender GmbH & Co. KG

All rights reserved.

Reprinting only with permission  
of the publisher.

Subject to change!

## Table of contents

<b>1. Making effective use of this document</b> .....	<b>7</b>
1.1 How to use this manual .....	7
1.2 Explanation of symbols and notes .....	8
<b>2. Safety instructions</b> .....	<b>9</b>
2.1 Intended use .....	9
2.2 Qualified personnel .....	10
2.3 Safety information .....	11
2.4 Delivery conditions, guarantee, warranty and liability .....	11
<b>3. System description</b> .....	<b>13</b>
3.1 Features .....	13
3.1.1 Areas of application .....	13
3.1.2 Standards .....	13
3.1.3 System versions .....	13
3.1.4 System features .....	13
3.2 Function of the EDS system .....	14
3.2.1 Block diagram EDS system .....	15
3.2.2 Test cycle .....	16
3.2.3 Currents in the EDS system .....	17
3.2.4 Requirements for reliable insulation fault location .....	18
<b>4. Installation and connection</b> .....	<b>21</b>
4.1 Unpacking .....	21
4.2 Fuses, max. voltage, cable lengths .....	22
4.3 Notes on mounting .....	22
4.3.1 Dimension diagram EDS460/461-D/-L .....	23
4.3.2 Dimension diagram EDS490/491-D/-L .....	23

4.4	Connection .....	24
4.4.1	Wiring diagram EDS460/461-D / -L .....	24
4.4.2	Wiring diagram EDS490/491-D / -L .....	26
4.4.3	Connection of W..., WR..., WS...-series measuring current transformers .....	28
4.4.4	Connection example EDS standard system with FTC4...XET .....	29
<b>5.</b>	<b>Commissioning .....</b>	<b>31</b>
5.1	Before switching on .....	31
5.2	Switching on .....	32
<b>6.</b>	<b>Operation .....</b>	<b>35</b>
6.1	EDS...-D operating and display elements .....	35
6.2	EDS...-L operating and display elements .....	36
6.3	Working in operating mode .....	37
6.3.1	Standard display .....	37
6.3.2	Alarms and their effects .....	37
6.3.3	Carrying out a test .....	39
6.3.4	Resetting saved alarm messages (RESET) .....	40
6.3.5	Displaying standard information .....	41
6.4	Setting the EDS...-L .....	42
6.5	Operating and setting the EDS...-D .....	42
6.5.1	Opening the main menu .....	43
6.5.2	Menu overview diagram .....	44
6.5.3	Main menu functions .....	45
6.6	The main menu .....	46
6.6.1	Menu 1: Alarm/meas. values .....	46
6.6.2	Menu 2: History .....	48
6.6.3	Menu 3: Settings .....	49
6.6.3.1	Settings menu 1: General .....	50
6.6.3.2	Settings menu 2: Channel .....	51
6.6.3.3	Settings menu 3: Relay .....	55
6.6.3.4	Settings menu 4: History .....	56

6.6.3.5	Settings menu 5: Language .....	56
6.6.3.6	Settings menu 6: Interface .....	56
6.6.3.7	Settings menu 7: Alarm addresses .....	57
6.6.3.8	Settings menu 8: Clock .....	57
6.6.3.9	Settings menu 9: Password .....	58
6.6.3.10	Settings menu 10: Factory settings .....	59
6.6.3.11	Settings menu 11: Service .....	59
6.6.4	Menu 4: Control .....	59
6.6.4.1	Control menu 1: TEST .....	59
6.6.4.2	Control menu 2: RESET .....	59
6.6.4.3	Control menu 3: Test communication .....	59
6.6.5	Menu 5: External devices .....	61
6.6.6	Menu 6: Info .....	64
<b>7.</b>	<b>Tests and service .....</b>	<b>65</b>
7.1	Periodic tests .....	65
7.2	Maintenance .....	65
7.3	Service .....	65
7.4	Troubleshooting .....	66
7.4.1	Display device error .....	66
7.4.2	Device error display (channel-related) .....	67
7.4.3	CT connection fault display (channel-related) .....	68
7.4.4	Display "peak" .....	68
7.4.5	External alarm .....	68
<b>8.</b>	<b>Data .....</b>	<b>69</b>
8.1	Standards .....	69
8.2	Approvals and certifications .....	69
8.3	Technical data EDS460/490/EDS461/491 .....	70
8.4	Response sensitivity characteristics .....	74
8.4.1	Characteristic curves EDS460/490 .....	77
8.4.1.1	EDS460/490 characteristics for 3AC systems .....	77
8.4.1.2	EDS460/490 characteristics for AC systems .....	80

8.4.1.3	EDS460/490 characteristics for DC systems .....	82
8.4.2	Characteristic curves EDS461/491 .....	84
8.4.2.1	EDS461/491 characteristics for AC systems .....	84
8.4.2.2	EDS461/491 characteristics for DC systems .....	87
8.5	Ordering information .....	89
<b>INDEX</b>	.....	<b>97</b>

# 1. Making effective use of this document

## 1.1 How to use this manual

This operating manual describes EDS460/490 resp. EDS461/491 insulation fault locators. It is designed for skilled persons working in electrical engineering and electronics and in particular for those designing, installing and operating electrical systems.

Before using the equipment, please read this operating manual, the supplement entitled "Important safety instructions for Bender products", the "BMS bus" instruction leaflet, as well as the instruction leaflets supplied with the individual system components. Please keep this documentation close at hand near to the equipment.

Should you have any questions, please do not hesitate to contact our technical sales team. We are also happy to provide on-site services. Please contact our Service Department for more information.

Service-Hotline: 0700-BenderHelp (Telephone and Fax)

Carl-Benz-Straße 8 • 35305 Grünberg • Germany

Tel: +49 6401 807-760 • Fax: +49 6401 807-629

E-Mail: [info@bender-service.com](mailto:info@bender-service.com) • [www.bender.de](http://www.bender.de)

Although great care has been taken in the drafting of this operating manual, it may nevertheless contain error and mistakes. The Bender group cannot accept any liability for injury to persons or damage to property resulting from errors or mistakes in this manual.

## 1.2 Explanation of symbols and notes

The following terms and symbols are used to denote hazards and instructions in Bender documentation:



This signal word indicates that there is a **high risk of danger** that will result in **electrocution** or **serious injury** if not avoided.



This signal word indicates a **potential risk of danger**. Failure to observe the associated instructions and take appropriate precautions may result in death, serious physical injury or substantial damage to property



This signal word indicates a **low level risk** that can result in **minor** or **moderate injury or damage to property** if not avoided.



This symbol denotes important information intended to assist the user in making **optimum use** of the product.



## 2. Safety instructions

### 2.1 Intended use

EDS... insulation fault locators are used for localisation of insulation faults in unearthed DC, AC and three-phase power supply systems (IT systems). Alternating and three-phase systems in the range of AC 24 to 690 V and DC systems in the range of DC 24 to 500 V can be monitored. The operating frequency is optionally DC, 50, 60 or 400 Hz. The nominal system voltage varies with the type of locating current injector (PGH47., IRDH575).



*If the locating current is too high, IRDH575 or PGH... may damage sensitive loads (e.g. in control circuits) or may accidentally activate switching operations. Therefore, it is recommended to use a PGH... with a low locating current or to set a low locating current at the IRDH575. The response sensitivity of EDS461/491 insulation fault locators is higher and hence they are capable of evaluating this low locating current.*

*In case of doubt, please contact a Bender product manager.*

An EDS system consists of the insulation fault locators EDS460/490 or EDS461/491 and either the A-ISOMETER® IRDH575 or locating current injector PGH. Using measuring current transformers, EDS460/490 or EDS461/491 insulation fault locators detect locating current signals generated by the IRDH575 insulation monitoring device or PGH... locating current injector and evaluate them.

Up to 12 measuring current transformers can be connected to one EDS.... Up to 90 EDS... insulation fault locators can be connected via a BMS bus (RS-485 interface with BMS protocol), thereby up to 1080 measuring channels (sub-circuits) can be monitored. The scanning time for all channels is

- for EDS460/EDS490 approx. 8...24 s
- for EDS461/EDS491 approx. 14...30 s

The individual parameterisation, necessary to adjust the insulation fault locator to the existing system and utilisation conditions, must be carried out at the place of utilisation in order to meet the requirements laid down in the standards.

Please take note of the limits for the application area specified in the technical data. Any other use, or use which goes beyond the foregoing is deemed to be use other than for the intended purpose.

#### **Use for the intended purpose also includes:**

- The observation of all information in this operating manual.
- and the compliance with test intervals.

## **2.2 Qualified personnel**

Only skilled persons may work on Bender devices. Personnel who are familiar with the assembly, commissioning and operation of the equipment and have undergone appropriate training are considered qualified. Such personnel must have read this manual and understood all instructions relating to safety.

## 2.3 Safety information

Bender devices are built in accordance with the state of the art and accepted rules in respect of technical safety. Nevertheless, the use of such devices may introduce risks to the life and limb of the user or third parties and/or result in damage to Bender devices or other property.

- Only use Bender devices:
  - for the purpose for which it is intended;
  - when it is in perfect condition as far as safety is concerned;
  - in compliance with the accident prevention regulations and guidelines applicable in the location of use.
- Any faults which may impair safety must be eliminated immediately.
- Do not make any unauthorised changes and only use replacement parts and optional accessories purchased from or recommended by the manufacturer of the equipment. Failure to observe this requirement can result in fire, electric shock and injury.
- Warning signs must always be easily legible. Damaged or illegible signs must be replaced immediately.

## 2.4 Delivery conditions, guarantee, warranty and liability

The conditions of sale and delivery set out by Bender shall apply. Conditions of sale and delivery can be obtained from Bender in printed or electronic format.



## 3. System description

### 3.1 Features

#### 3.1.1 Areas of application

- Insulation fault location in AC, AC / DC and DC IT systems
- Main and control circuits in industrial installations and ships
- Diode-decoupled DC IT systems in power stations
- Systems for medical locations

#### 3.1.2 Standards

The standard for unearthed power supply systems (IT systems) IEC 60364-4-41 requires that a first fault is to be eliminated with the shortest practicable delay. Fast insulation fault location is possible with EDS systems.

#### 3.1.3 System versions

EDS460, EDS461, EDS490 or EDS491 insulation fault locators differ in their response sensitivity and/or number of alarm relays.

#### 3.1.4 System features

- Universal system concept;
- Modular design, hence easily adaptable to the individual conditions of the system;
- Measuring current transformers in various sizes and types of construction;
- Communication between the components via BMS bus (two-wire);
- All measuring current transformers are scanned simultaneously;
- Central indication of faulty sub-circuits;
- Various setting options allow individual adjustments;
- Connection to higher level control and visualisation systems can easily be established.

## 3.2 Function of the EDS system

When an insulation fault is detected by the insulation monitoring device in the IT system, the insulation fault location process will be started.

On the occurrence of a first insulation fault, a fault current essentially determined by the system leakage capacitances flows in the IT system. The fundamental idea in fault location is therefore to close the fault current loop for a short period via a defined resistance. As a result of this principle, the system voltage itself drives a locating current containing a signal that can be evaluated.

The locating current signals are generated periodically by the IRDH575 respectively the PGH... . The locating current is limited in amplitude and time. As this happens, the system conductors are connected alternately to earth via a defined resistance. The locating current generated in this manner depends on the magnitude of the present insulation fault and the system voltage. It is limited according to the setting of the IRDH575 respectively the PGH... . For planning purposes, it should be noted that no system components are present in which this locating current can bring about a damaging reaction, even in unfavourable cases.

The locating current pulse flows from the locating current injector via the live parts, taking the shortest path to the location of the insulation fault. From there, it flows via the insulation fault and the PE back to the IRDH575 respectively PGH... . This locating current pulse is then detected by the measuring current transformers located in the insulation fault path, and is signalled by the connected insulation fault locator.

Additional information is available in the data sheet "Technical issues affecting the use of insulation fault location systems".

### 3.2.1 Block diagram EDS system

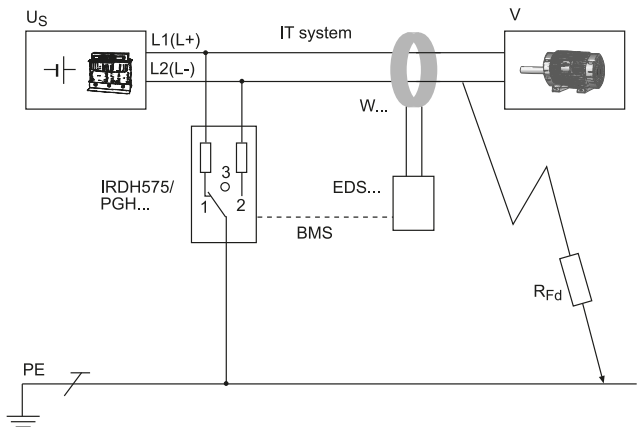

#### Legend

EDS...	Insulation fault locator
PGH...	Locating current injector
IRDH575	A-ISOMETER® IRDH575 with integrated locating current injector
$U_s$	Current source IT system
$W$	Measuring current transformer
$V$	Electrical load
$R_{Fd}$	Insulation fault downstream of the measuring current transformer
PE	Protective conductor respectively equipotential bonding conductor
BMS	BMS bus

### 3.2.2 Test cycle

The duration of a locating current pulse cycle is 6 seconds. The IRDH575 or PGH... alternatively sends positive or negative locating current pulses. The test cycle of the IRDH575 or PGH... is shown in different switch positions (1,2,3) in the block diagram below, („Block diagram EDS system“ on page 15).

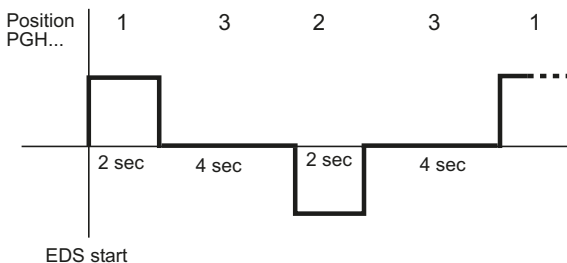



### 3.2.3 Currents in the EDS system

In addition to the block diagram on page 15, the path of the residual currents and the locating current is shown in the diagram below:

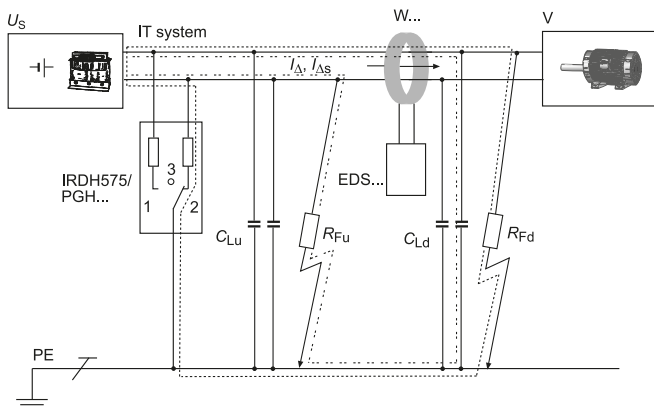

#### Legend

.....	Locating current loop $I_{\Delta S}$
.. . . .	Residual currents $I_{\Delta}$ (example)
$C_{Lu}$	Upstream capacitances, system leakage capacitances upstream the measuring current transformer.
$C_{Ld}$	Downstream capacitances, system leakage capacitances downstream the measuring current transformer.
$R_{Fu}$	Insulation fault upstream the measuring current transformer.
$R_{Fd}$	Insulation fault downstream the measuring current transformer.

The following residual currents flow through the measuring current transformer of the EDS... :

- The locating current  $I_{\Delta S}$  caused by the insulation fault  $R_{Fd}$
- Residual currents  $I_{\Delta}$  flowing through the system leakage capacitances  $C_{Lu}$ , and  $C_{Ld}$ , respectively which are caused by  $R_{Fu}$  and  $R_{Fd}$
- Transient leakage currents caused by switching and control activities in the system
- Low-frequency leakage currents caused by the use of converters

### 3.2.4 Requirements for reliable insulation fault location

The EDS... is intended to locate insulation faults downstream of the measuring current transformer  $R_{Fd}$ . For this purpose, the locating current caused by the insulation fault has to be detected reliably, subject to the condition that:

- The locating current  $I_{\Delta S}$  for the EDS460/490 is more than 1.5 mA and less than 50 mA.
- The locating current  $I_{\Delta S}$  for the EDS461/491 is more than 0.15 mA and less than 5 mA.
- The upstream capacitances  $C_{Lu}$  must be at least as large as the downstream capacitances  $C_{Ld}$ .
- The system leakage capacitance does not have to be too large (see „Response sensitivity characteristics“ on page 74).
- The total residual current through the measuring current transformer (locating current and residual currents etc.) may be a maximum of 10 A (EDS460/490) respectively 1 A (EDS461/491).
- Not only does the amplitude influence the reliable detection of the locating current but also the residual current frequency. This effect is illustrated in the following fault curve.

## Fault curve

Safe insulation fault location is only possible in the grey-shaded area.

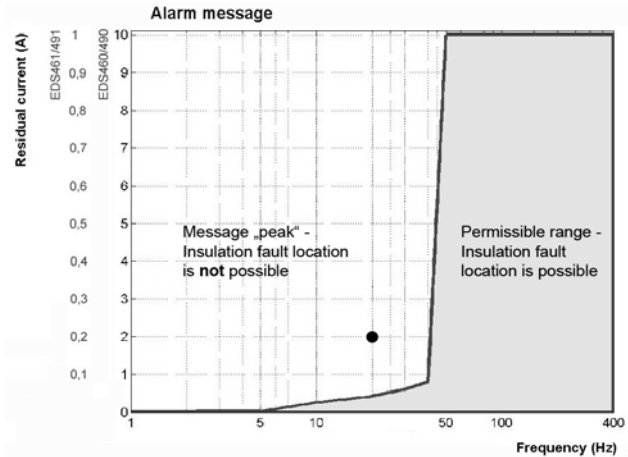

A measuring channel where insulation fault location is not possible is marked with "peak" in the "Alarm/meas. values" menu.

Example: A residual current of 2 A/20 Hz (marked with a point (•) in the diagram) would be outside the permissible range.



*Symmetrical insulation faults downstream of the measuring current transformer are not recognised under certain circumstances.*

*Low-frequency residual currents (caused by converters, for example) may have the effect that insulation faults cannot be found when their frequency is equal or nearly equal the test cycle frequency of the IRDH575 respectively PGH... .*



---

## 4. Installation and connection

### 4.1 Unpacking

- Unpack all the parts supplied with the system. Do not use tools with sharp edges which might damage the content of the package.
- Compare your order with our delivery note to check that you have received all products in full. The article numbers printed on the nameplates simplifies the identification of the devices.
- Check all parts supplied for any evidence of damage in transit. Equipment damaged in transit must not be used. If a device has sustained damage, please contact Bender. Details of who to contact are indicated on the delivery documents.
- When storing the devices in a cold environment as it is in winter the following is to be considered: Leave the devices to stand for 3 to 4 hours at room temperature before connecting the power supply. When the devices are moved from a cold to a warm environment, condensation will be evident on all parts. Putting damp devices into operation risks damaging electrical components and there is a danger of electric shock on contact.

## 4.2 Fuses, max. voltage, cable lengths

- Equip the supply voltage of all system components with fuses so that they are protected in the event of a short circuit. We recommend that you use 6 A fuses. **For UL and CSA applications, the use of 5 A fuses is mandatory.**
- Please note: The maximum voltage of the monitored system must not exceed the rated insulation voltage of the measuring current transformer used in the EDS system and the IRDH575 or PGH...
- Select the cables and cable lengths in accordance with the technical data on Seite 70. If you use cables that are longer than those specified here, Bender cannot guarantee that the equipment will function safely.

## 4.3 Notes on mounting



**DANGER**

*Before mounting the device and working on the device connections, make sure that the power supply voltage has been disconnected. Failure to comply with this requirement will expose personnel to the risk of electric shock. Furthermore, the electrical installation may sustain damage and the device may be destroyed beyond repair.*

The devices are suitable for the following types of installation:

- standard distribution panels according to DIN 43871 or
- DIN rail mounting according to IEC 60715 or
- screw mounting using M4 screws.

Mount the measuring current transformers in accordance with the notes in the "Transformer installation" technical information. When connecting the measuring current transformers, it is essential that you observe the maximum cable lengths.

### 4.3.1 Dimension diagram EDS460/461-D/-L

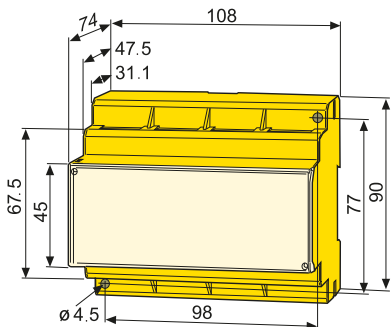

### 4.3.2 Dimension diagram EDS490/491-D/-L

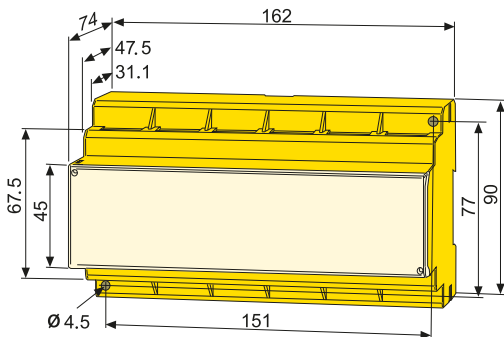

*Dimensions in mm*

## 4.4 Connection

### 4.4.1 Wiring diagram EDS460/461-D / -L

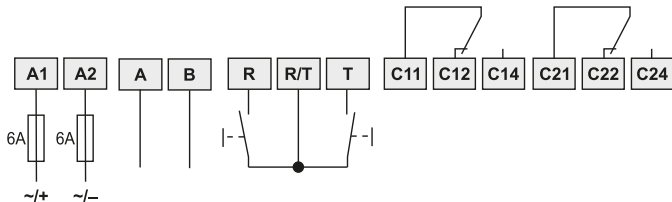
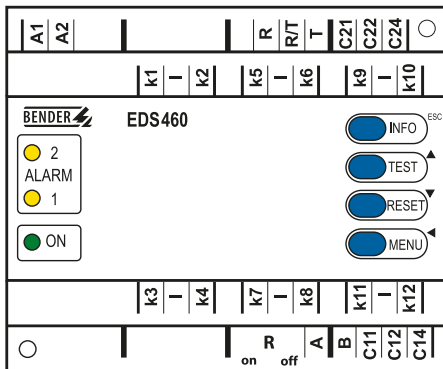
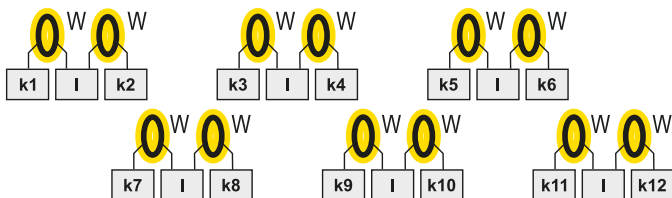



## Legend to wiring diagram

A1, A2	Supply voltage $U_5$ (see ordering information), 6 A fuse recommended; two-pole fuses should be used on IT systems. For UL and CSA applications, the use of 5 A fuses is mandatory.
k1, l ... k12, l	Connection of measuring current transformers 1...12
A, B	BMS bus (RS-485 interface with BMS protocol)
R, R/T	External reset button (N/O contact)*
T, R/T	External test button (N/O contact)*
C11, C12, C14	Common alarm relay K1: Alarm 1, common alarm for alarm or device error.
C21, C22, C24	Common alarm relay K2: Alarm 2, common alarm for alarm or device error.
$R_{on/off}$	Activate or deactivate the BMS bus terminating resistor (120 $\Omega$ ).
W	Measuring current transformer

\* *The external test/reset buttons of several devices must not be connected to one another.*



## Legend to wiring diagram

A1, A2	Supply voltage $U_S$ (see ordering information), 6 A fuse recommended; two-pole fuses should be used on IT systems. For UL and CSA applications, the use of 5 A fuses is mandatory.
k1, l ... k12, l	Connection of measuring current transformers 1...12
A, B	BMS bus (RS-485 interface with BMS protocol)
R, R/T	External reset button (N/O contact)*
T, R/T	External test button (N/O contact)*
C11, C12, C14	Common alarm relay K1: Alarm 1, common alarm for alarm or device error.
C21, C22, C24	Common alarm relay K2: Alarm 2, common alarm for alarm or device error.
$R_{on/off}$	Activate or deactivate the BMS bus terminating resistor (120 $\Omega$ ).
11, 14 ... 121, 124	Alarm relay per channel: One N/O contact per channel (e.g. N/O contacts 11,14 for channel 1).
W	Measuring current transformer

\* *The external test/reset buttons of several devices must not be connected to one another.*

### 4.4.3 Connection of W..., WR..., WS...-series measuring current transformers

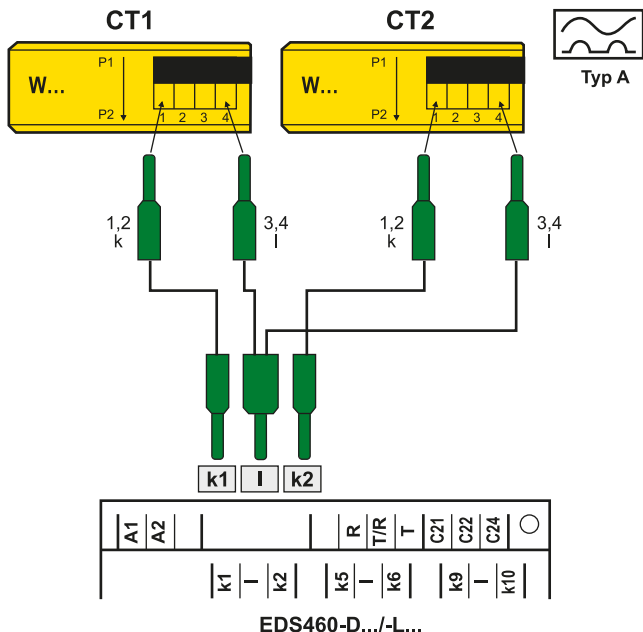

*Terminals 1 and 2 as well as terminals 3 and 4 are bridged internally.*

*The connections k and l at the EDS... must not be interchanged.*



*Ensure that all live conductors are routed through the measuring current transformer. Do not route any PE conductors or shields of shielded conductors through the measuring current transformer! Commercial measuring current transformers are not suitable for EDS460/461 or EDS490/491 systems and must not be used.*

*Only if these notes are observed will you obtain a true measurement result.*

*Additional information is available in our "Transformer installation" technical information.*

#### 4.4.4 Connection example EDS standard system with FTC4...XET

See the next page for this example.

##### Key for connection example:

IRDH575	Insulation monitoring device with integrated locating current injector.
EDS...	insulation fault locators
FTC4...XET	Protocol converter for connecting the BMS bus (Bender measuring device interface) with a TCP/IP (Transmission Control Protocol/Internet Protocol) network via Ethernet.

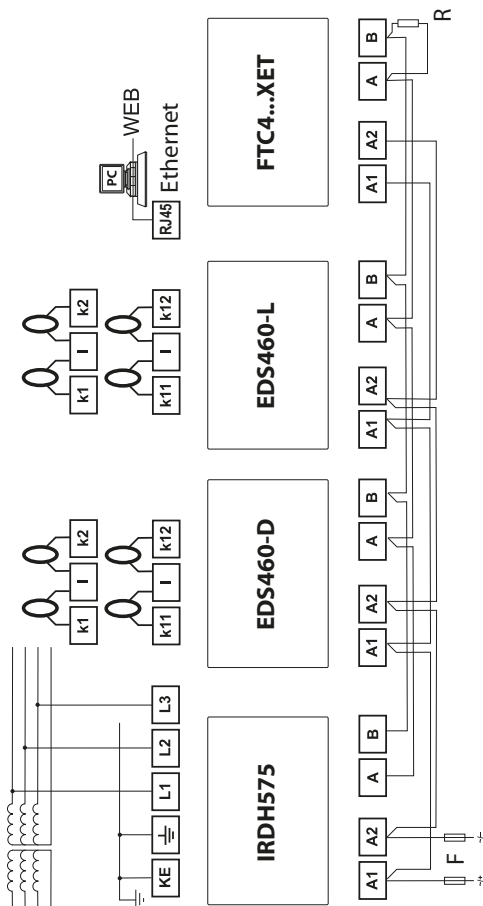
**Connection example**

## 5. Commissioning



*Note on opening the transparent front panel cover:  
Take hold of the cover at the bottom edge and swivel it upwards. The cover can also be removed completely. Once the adjustments have been completed, the front panel cover must be refitted.*

### 5.1 Before switching on

1. Does the connected supply voltage  $U_S$  match the information on the device nameplates?
2. Has the maximum permissible rated insulation voltage of the measuring current transformers and IRDH575 or PGH... been observed?
3. Are you sure that the PE conductor has not been routed through the measuring current transformer at any point?
4. In mounting the measuring current transformers, have any magnetic fields that are nearby and could cause interference been taken into account?
5. Has the maximum permissible cable length for the measuring current transformers been observed?
6. Is a 120  $\Omega$  resistor connected at the beginning and end of the BMS bus?
7. Have the maximum permissible interface cable length (1200 m) and number of BMS bus nodes (32) been observed?

8. In respect of the BMS bus node address settings, has each address only been assigned once? Is address 001 and therefore the master function, assigned?

## 5.2 Switching on

1. Connect the supply voltage of all devices connected to the BMS bus. Initially, the "ON" LED flashes on the EDS... and the EDS...-D graphic display shows the (Bender) welcome screen. The "ON" LED then lights up permanently.
2. Eliminate insulation and device errors. If a response value is exceeded or device error messages occur, this is indicated on the EDS... by means of the alarm LED lighting up and an associated message appearing on the graphic display (EDS...-D only).
  - You can find information about the alarms on the EDS...-D in the "Alarm/Meas. values" menu. Information on the EDS...-L can be displayed via the BMS master.
  - Eliminate the insulation faults detected by the EDS...
  - The EDS...-D indicates any device errors that have occurred on its display, the EDS...-L displays an error code.
  - Device errors may be caused by measuring current transformers not being connected. Check the measuring current transformer connections. Disable transformer monitoring for measuring channels that are not required (refer to Chapter 6.6.3.2 "Settings menu 2: Channel", submenu „2.CT“ on page 52).



*Due to the synchronisation processes on the BMS bus, current alarm messages may not be available for a short time. If however, the causes of the alarms are still present, the alarm messages will reappear after a few seconds.*



## Deactivation of the CT monitoring recommended

The connection and short-circuit monitoring of the measuring current transformer is deactivated ex works. It serves primarily used to facilitate the commissioning of the EDS system (it can be activated for this task). In the standard measurement mode, the monitoring function may cause false alarms due to interference signals occurring in the environment. Therefore, we recommend to deactivate the CT monitoring function after successful commissioning, see page 54.



## 6. Operation

### 6.1 EDS...-D operating and display elements

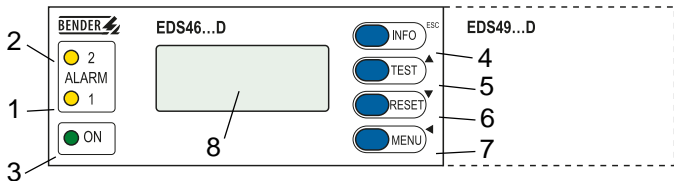

1	<p>Alarm LED 1 lights up in the event of the following types of device errors:</p> <ul style="list-style-type: none"> <li>- when the residual current is: &gt; 10 A for EDS460/490 or &gt; 1 A for EDS461/EDS491 (RCM function);</li> <li>- when there is a loss of power or short circuit in a measuring current transformer circuit (this function can be deactivated).</li> </ul>
2	Alarm LED 2 lights up if an insulation fault is detected on a measuring channel (EDS function).
3	The "ON" LED lights up when the device is switched on and flashes during power on until the device is ready for operation.
4	<p>INFO button: Calls up standard information.</p> <p>ESC button: Exits the menu function without changing parameters.</p>
5	<p>TEST button: Calls up the self test.</p> <p>UP button: Parameter change, scroll.</p>
6	<p>RESET button: Acknowledges alarm and fault messages.</p> <p>DOWN button: Parameter change, scroll.</p>
7	<p>MENU button: Toggles between the standard display, MENU and alarm display. ENTER button: Confirms parameter changes.</p>
8	Backlit graphical LC display ( refresh every 20 seconds)

## 6.2 EDS...-L operating and display elements

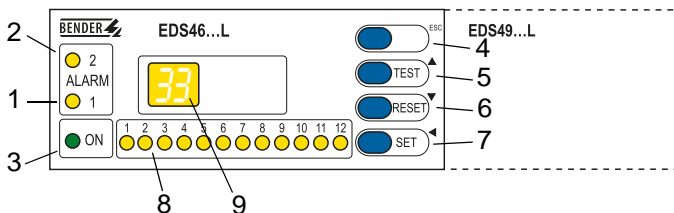

1	Alarm LED 1 lights up in the event of the following types of device error: <ul style="list-style-type: none"> <li>- when the residual current is: &gt; 10 A for EDS460/490 or &gt; 1 A for EDS461/EDS491 (RCM function);</li> <li>- when there is a loss of power or short circuit in a measuring current transformer circuit (this function can be deactivated).</li> </ul>
2	Alarm LED 2 lights up if an insulation fault is detected on a measuring channel (EDS function).
3	The "ON" LED lights up when the device is switched on and flashes during power on until the device is ready for operation.
4	ESC button: Exits the menu function without changing parameters.
5	TEST button: Calls up the self test. UP button: Parameter change, scroll.
6	RESET button: Acknowledges alarm and fault messages. DOWN button: Parameter change, scroll.
7	SET button: Sets the BMS address. ENTER button: Confirms parameter changes.
8	Alarm-LEDs "1...12" light up if an insulation fault has been detected in the relevant measuring channel. They flash in case of interruption of a CT circuit or in case of a short circuit in a CT circuit.
9	Digital display for device address and error codes.

## 6.3 Working in operating mode

### 6.3.1 Standard display

In operating mode, the EDS... waits for insulation fault location to begin. The schematic representation shows that no alarm message exist on all of the 12 channels(O).

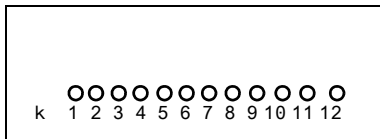

The EDS...-L displays its BMS bus address (e.g. 02). Only the green "Power ON" LED is lit.

### 6.3.2 Alarms and their effects

Possible causes of alarm messages include:

- Insulation faults or residual currents > 10 A (EDS460/490) or > 1A (EDS461/491).
- A measuring current transformer or measuring current transformer connection fault.
- Device error

The EDS... signals alarm or device error:

- "ALARM 1" LED lights up if the residual current is: > 10 A (EDS460/490) or > 1 A (EDS461/491) or in the event of a CT connection fault.
- "ALARM 2" LED lights up when an insulation fault is located.
- Assigned common alarm relays switch.
- An alarm message is being sent to the BMS bus.
- EDS...-D: An alarm message is shown on the display. An entry is made in the history memory.
- EDS...-L: The alarm LED of the affected measuring channel lights up or flashes.

- EDS...-D: An alarm message is shown on the display.

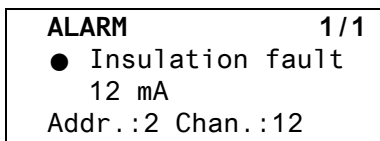

Line 1: ALARM,

Alarm 1 of 1 pending alarm

Line 2: Alarm status and alarm text

○ No alarm  
 ● ALARM

Line 3: Currently measured mean value of the locating current.

Line 4: BMS bus address of the EDS and measuring channel on which the alarm has occurred.

Press the "INFO" button to display the schematic representation for this alarm message. Channels where an alarm exists are marked with the ● symbol.

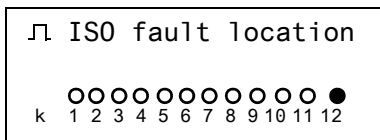

- EDS...-L: The alarm LED of the affected channel lights or flashes in case of a device error.

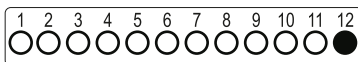

### 6.3.3 Carrying out a test

A test serves to check the device function (hardware components) of the EDS.

A test can be called in the following ways:

- Select the standard display, then press and hold down the "TEST" button on the EDS... front panel for at least one second
- Press an external test button connected to the EDS...
- Send a test command via the BMS bus
- EDS...-D only: Call the "TEST" function in the Control menu

The EDS... responds as follows:

- "ALARM 1" and "ALARM 2" LEDs light up.
- All alarm relays switch (function can be deactivated, see Seite 55).
- An alarm message is being sent to the BMS bus.
- An entry is made in the history memory with the suffix "TEST".
- EDS...-D: The progress of the test is shown on the display.

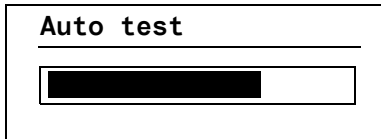

- EDS...-D: An alarm message is shown on the display.

The EDS...-D will now display the maximum measured value that can be detected (provided that the measuring channel is functioning correctly). Press the "▼" arrow button several times to show that the other channels are functioning correctly.

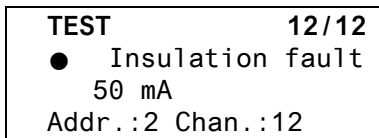

- EDS...-L: All alarm LEDs light up.

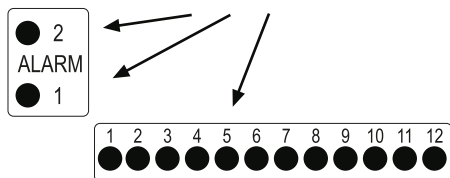

Once the test has been completed, all LEDs must go out again, with the exception of the "ON" LED.

### 6.3.4 Resetting saved alarm messages (RESET)

If the fault memory is enabled, the alarm status will remain, even after the cause of the fault has been eliminated, until a "RESET" is carried out. Press the "ESC" button to exit the display of the current alarm message. To carry out a RESET:

- Select the standard display, then press and hold down the "RESET" button on the EDS... front panel for at least one second
- Press the external reset button connected to the EDS...
- Send a reset command via the BMS bus
- EDS...-D only: Call the "RESET" function in the Control menu

Stored alarm messages that are no longer pending are reset, the alarm relay drops out, the ALARM LEDs go out and there are no longer any alarm messages on the BMS bus. The EDS...-D shows the progress of the reset operation.



### 6.3.5 Displaying standard information

This function is only available in EDS...-D. Press the "INFO" button. You will now see information relating to the device and software on the EDS...-D display. Press the "▼" arrow button several times to display all the information. Please have this information to hand if you should need to contact us for assistance by telephone.

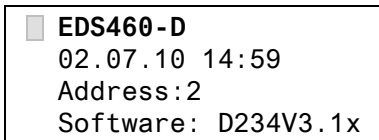

Line 1: Device type

Line 2: Date, time

Line 3: Address set on the BMS bus

Line 4: Software version of measurement technique

Line 5: Date of the measurement technique software version

Line 6: Communication software version

Line 7: Date of communication software version

Line 8...10: Bender address, homepage

Line 11: Exit. Exit standard information.

## 6.4 Setting the EDS...-L

EDS...-L has a 7-segment LED display only. It can be operated and set via an EDS...-D or via the following devices: IRDH575 (V1.5 or higher), MK800 or FTC4...XET. Only the BMS bus address can be set directly on the EDS...-L.

The following functions and settings are **not** included in the EDS...-L :

- Displaying standard information	- Time of day/ date
- Language	- Interface menu
- History memory	- Password

### Setting the BMS bus address of the EDS...-L

1. Press the "SET" button for approximately two seconds to open the main menu. The BMS bus address flashes.
2. Use the arrow buttons "▲, ▼" to select the required address.
3. Press the Enter button "↵" to confirm this setting.
4. If you wish to exit the setting without making a change, press the "ESC" button.

## 6.5 Operating and setting the EDS...-D

This chapter describes the EDS...-D menu mode.

The EDS...-L only has some of these functions available (see „Setting the EDS...-L“ on page 42). This also applies if an EDS...-D is used to operate and set an EDS...-L.

### 6.5.1 Opening the main menu

Press the "MENU" button to open the main menu.

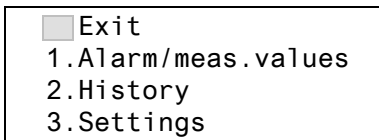

The following buttons are used in the main menu:

ESC Exit function or go up one menu level.

▲, ▼ Select menu items

↵ Confirm selected menu item (Enter)



*Menu mode is exited if no button is pressed for longer than five minutes. Exceptions: The "Test" and "Test communication" functions.*



*Settings can be password protected. When an attempt is made to change settings, the password entry screen appears automatically: For details see "Settings menu 9:*

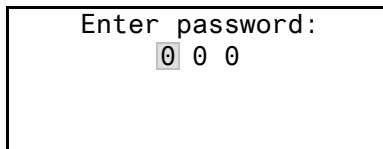

*Password" on page 58. If you can't remember your password, contact the Bender Service.*

## 6.5.2 Menu overview diagram

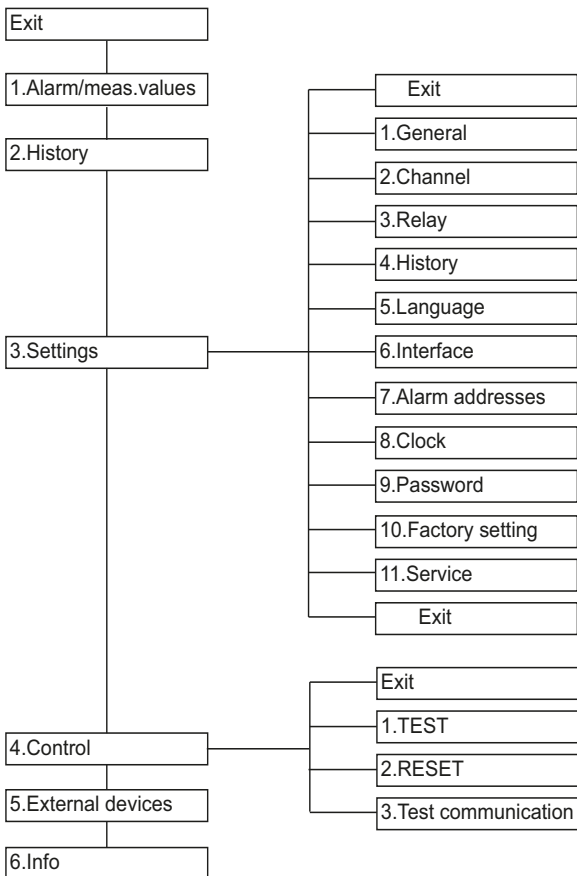

### 6.5.3 Main menu functions

Menu item	Function	Page
Exit	Exit menu mode	-
1. Alarm/meas. values	Displays the following for each measuring channel: Alarm status, locating current $I_{\Delta S}$ , residual current $I_{\Delta}$	46
2. History	Displays the history (300 data records) with information about messages, acknowledgements and associated times. Displays the minimum and maximum $I_{\Delta S}$ measured value, with address and channel.	48
3. Settings	Settings for EDS... are made here.	49
4. Control	This menu offers various control options, such as TEST, RESET, Test communication.	59
5. External devices	Settings on devices externally connected to the BMS bus (e.g. EDS460-D/-L, EDS490-D/-L).	61
6. Info	Information on the device. The same display is obtained by pressing the INFO button in the operating mode (refer to „Displaying standard information“ on page 41).	64

## 6.6 The main menu

### 6.6.1 Menu 1: Alarm/meas. values

EDS... displays the following for each measuring channel: Alarm status, locating current  $I_{\Delta s}$ , residual current  $I_{\Delta}$ .

	I (ds)	I (d)
1.	● 6mA	120mA
2.	○ --	<100mA
3.	○ Channel disabled	

Column 1: Channel number 1...12

Column 2: Alarm status:



No alarm



Alarm

Column 3: I(ds):

Currently measured locating current  $I_{\Delta s}$

Column 4: I(d):

Currently measured residual current  $I_{\Delta}$



*The accuracy of the displayed locating current depends on the system leakage capacitances.*

*The IRDH575/PGH... locating current is limited. Consequently, the insulation fault resistance may in fact be lower than the displayed locating current suggests.*

## Residual current

The residual current flowing through the measuring current transformer is continually measured and displayed.

- If the residual current exceeds 100 mA (EDS460/490) or 10 mA (EDS461/491), this information is displayed.
- If the residual current exceeds 10 A (EDS460/490) 1 A (EDS461/491), this information is displayed. Once the residual current reaches values of this magnitude, reliable insulation fault location becomes impossible.

<b>ALARM</b>	<b>1 / 1</b>
● Residual current	
> 10 A	
Addr.: 2	Chan.: 1

## 6.6.2 Menu 2: History

The non-volatile history memory saves up to 300 data records (alarms, device errors). If the history memory is full, the oldest entry will be deleted in the event of an alarm to create space for the new entry. For details about erasing the entire history memory refer to "Settings menu 4: History" on page 56.

```
History no. 297
Start: 21.06.2010 / 15:57:00
Quit:
End:   21.06.2010 / 16:07:03
```

Line 1: Event number (if applicable): TEST.

Line 2: Event start: Date/time

Line 3: Event acknowledgement (e.g. alarm deleted at IRDH575, MK800, FTC4...): Date/time

Line 4: Event end: Date/time

1. If you are searching for an event that occurred at a specific time, use the arrow buttons to scroll to the required entry.
2. Use the "↓" button to call up details about the current history memory entry.

```
History no. 297
● Insulation fault
Min. 2mA/Max. 50mA
Addr.: 2 Chan.: 1
```

Line 1: Event number (if applicable): TEST.

Line 2: Alarm/device error designation.

Line 3: Minimum and maximum measured value.

Line 4: Address and measuring channel of device sending the message



### 6.6.3 Menu 3: Settings

The following menu items are available for configuring the EDS...:

Menu item	Function	Page
Exit	Exit settings	-
1.General	Configure the fault memory, trigger, rated frequency and type of system.	50
2.Channel	Configure the following in respect of each measuring channel: Response value, measuring transformer type, response delay, delay on release, measuring transformer monitoring, filters for systems with inverters, and alarm when the residual current has been exceeded.	51
3.Relay	Set the relay mode of operation and type of fault that you wish to cause a switching operation for common alarm relay.	55
4.History	Erasing the history memory	56
5.Language	Select the language for menu and alarm texts	56
6.Interface	Configure the BMS bus address of the EDS...	56
7.Alarm-addresses	Setting of bus addresses for devices whose alarm messages are to be displayed on this EDS...-D.	57
8.Clock	Configure the time, date, date format and summer time changeover.	57
9.Password	Changing and activating the password.	58
10.Factory setting	Resets every setting to its factory setting.	59
11.Service	For Bender service staff only.	59



*Some settings are only available for specific EDS... versions (e.g. EDS460/490 only). The sequence of the submenus may deviate from the settings menu described below.*

### 6.6.3.1 Settings menu 1: General

Use this menu to make settings that apply to the whole device and therefore to all channels.

#### 1.Memory

Faults that only occur temporarily can be saved.

ON After the cause of fault has been eliminated, all alarm messages remain saved until a RESET is carried out. This function relates to alarm and device error messages.

OFF EDS... exits the alarm status as soon as the cause of the error is eliminated.

#### 2.Trigger (EDS460/490 only)

The IRDH575/PGH... locating current pulse is synchronised with the EDS... measurement technique. The EDS... is told when to expect a locating current pulse. This means that locating current pulses can still be reliably detected in the event of interference. Sources for interference include, for example, variable-speed drives, power converters, actuators, suppressor filters, PLCs or control electronics.

Select:

Com Synchronisation via BMS bus. The EDS... will begin searching for insulation faults as soon as insulation fault location is started. It knows when to expect the locating current pulse. Insulation fault location is performed more quickly than with the "auto" setting.

auto No synchronisation (e.g. if there is no BMS bus). The EDS searches continually for insulation faults.

### 3.Frequency

Select the rated frequency of the monitored system. This must be set correctly, otherwise the EDS... will not be able to evaluate the locating current pulse accurately.

Configurable values: DC, 50 Hz, 60 Hz, 400 Hz

### 4.System type

Select the type of distribution system for the system being monitored.

Configurable values: DC, AC, 3 AC.

#### 6.6.3.2 Settings menu 2: Channel

You make the measuring channel settings in this menu (either individually or for all channels simultaneously). Selecting a measuring channel:

1. Use the "▲" button to go to the measuring channel setting. Press "↵".
2. Use the UP/DOWN buttons to select a single measuring channel or all measuring channels (1...12). Press "↵" to confirm your selection.

Setting  
a single  
measuring channel:

Chan.:	1
<input type="checkbox"/> Exit	
1.Resp.value:	4mA
2.CT:	W/WR

Setting  
all measuring channels:

Chan.:	1..12
<input type="checkbox"/> Exit	
1.Resp.value:	4mA
2.CT:	W/WR



*If the measuring channel settings only differ slightly, we recommend to proceed as follows:*

- First set all the channels (1...12) to the same value.
- Then modify the settings of individual channels.

## 1. Response value

An alarm is output when the measured value reaches the response value. Response ranges:

EDS460/4902...10 mA

EDS461/4910.2...1 mA

Please also heed the characteristics for a reliable response on Seite 74.

## 2. CT

Set the transformer type.

W/WR Bender standard measuring current transformers, circular and rectangular W... and WR... series designs.

WS Split-core type WS... series measuring current transformers.

off measuring channel is deactivated

The following measuring current transformer types can be used:

EDS460, EDS490: W..., WR..., WS...

EDS461, EDS491: W.../8000, WS.../8000

## 3. Response delay $T(\text{on})$

This is the response delay before the alarm is activated. This time delay is necessary in cases where the monitored system is subject to interference. The duration of a locating current pulse cycle is 6 seconds. Consequently, the response delay can only be adjusted in increments of 6 seconds.

0s EDS4.0: An alarm is triggered when the second locating current pulse is detected.

EDS4.1: Three locating current pulses must be detected before an alarm is triggered.

6s EDS4.0: Three locating current pulses must be detected before an alarm is triggered.

EDS4.1: Four locating current pulses must be detected before an alarm is triggered.

- 12s EDS4.0: Four locating current pulses must be detected before an alarm is triggered.  
EDS4.1: Five locating current pulses must be detected before an alarm is triggered.
- Configurable values: 0s, 6s, 12s, 18s, 24s

#### 4.Delay on release $T(\text{off})$

This function is only effective when the fault memory is deactivated (see "1.Memory" on page 50).

If the status that triggered the alarm no longer applies, the EDS... will terminate its alarm once the delay on release has expired.

Configurable values: 0s, 6s, 12s, 18s, 24s

- 0s The alarm is terminated when the EDS4.0 has not recognised an insulation fault for the duration of two locating current pulses.  
The alarm is terminated when the EDS4.1 has not recognised an insulation fault for the duration of three locating current pulses.
- 6s The alarm is terminated when the EDS4.0 has not recognised an insulation fault for the duration of three locating current pulses.  
The alarm is terminated when the EDS4.1 has not recognised an insulation fault for the duration of four locating current pulses.
- 12s The alarm is terminated when the EDS4.0 has not recognised an insulation fault for the duration of four locating current pulses.  
The alarm is terminated when the EDS4.1 has not recognised an insulation fault for the duration of five locating current pulses.



*In the case of "DC" systems, "6 s" is preset. IRDH575/PGH... sends alternate positive and negative locating current pulses. However, in a DC system, locating current pulses must either be all positive or all negative. As only every second locating current pulse counts, the system must wait for a further locating current pulse to be sent before it can be certain that this measuring channel is free from insulation faults.*

## 5.CT monitor

Enable or disable monitoring of the measuring current transformers.

- ON Measuring current transformers are monitored.  
Open circuit, short circuit or missing measuring current transformers generate an alarm message. The "ALARM 1" LED lights up.
- OFF Measuring current transformers are not monitored.

## 6.Inverter (EDS460/490 only)

Inverters are a major source of interference for the monitored system.

- ON Channel is optimised for inverters. Insulation fault location takes longer in this sub-circuit.
- OFF Channel is not optimised for inverters. Insulation faults cannot be reliably detected in circuits containing inverters.

## 7.Alarm I(d)

If the residual current exceeds  $> 10$  A (EDS460/490) resp.  $> 1$  A (EDS461/491), an alarm message is displayed (Alarm 1). This alarm message can be deactivated.

- ON Alarm when the residual current response value is exceeded.
- OFF No alarm when the residual current response value is exceeded (for specific applications only).

## 8.Relay mode (EDS490/491 only)

The EDS490-D/-L resp. the EDS491-D/-L has an alarm relay for each measuring channel. Set the relay mode of operation for each relay.

- N/O-T N/O operation. Relay switches in the event of an alarm or a test.
- N/C-T N/C operation. Relay switches in the event of an alarm or a test.
- N/O N/O operation. Relay only switches in the event of an alarm.
- N/C N/C operation. Relay only switches in the event of an alarm.



*If the relay settings only differ slightly, we recommend the following procedure for the EDS490:*

- first set all the relays (1...12) to the same value;
- then modify the settings of individual relays.

### 6.6.3.3 Settings menu 3: Relay

You make the settings for the common alarm relays K1 and K2 in this menu (either individually or common to all alarm relays). Selecting a relay

1. Use the "▲" button to go to the relay channel setting. Press "↵".
2. Use the UP/DOWN buttons to select a relay (1, 2) or for both relays (1...2). Press "↵" to confirm your selection.

Setting  
a single relay:

Relay:	1
<input type="checkbox"/> Exit	
1. Relay mode:	N/O-T
2. Alarm:	on

Setting  
both relays:

Relay:	1...2
<input type="checkbox"/> Exit	
1. Relay mode:	N/O-T
2. Alarm:	on

#### 1. Relay mode

Set the relay mode of operation:

N/O-T N/O operation. Relay switches in the event of an alarm or a test.

N/C-T N/C operation. Relay switches in the event of an alarm or a test.

N/O N/O operation. Relay only switches in the event of an alarm.

N/C N/C operation. Relay only switches in the event of an alarm.

## 2.Alarm

- ON Relay switches in the event of an alarm.  
OFF Relay does not switch in the event of an alarm.

## 3.Device error

- on Relay switches in the event of a device error.  
off Relay does not switch in the event of a device error.

## 4.Ext. alarm (EDS...-D only)

- on Relay switches in the event of an internal alarm or an external alarm\*.  
off Relay does not switch in the event of an internal alarm or an external alarm\*.

\* Alarm on an external device the address of which has been set to "on" in the "Alarm addresses" menu. (see "Settings menu 7: Alarm addresses" on page 57).

### 6.6.3.4 Settings menu 4: History

Here the entire history memory can be deleted. Use the "↵" button to confirm that the memory is to be deleted.

### 6.6.3.5 Settings menu 5: Language

Select the language for menu and alarm texts.  
Setting options: English, Deutsch or Français.

### 6.6.3.6 Settings menu 6: Interface

Set the BMS bus address of the EDS... .

- |                |          |                |
|----------------|----------|----------------|
| Setting range: | EDS...-D | Address 1...90 |
|                | EDS...-L | Address 1...90 |



### 6.6.3.7 Settings menu 7: Alarm addresses

Setting of the bus addresses (1...150) externally connected to the BMS bus, the alarm messages of which are to be displayed on this EDS...-D. Set the addresses of devices whose messages are to be displayed to "on". Addresses set to "on" are monitored for presence on the BMS bus; if a device cannot be found on the bus, a corresponding message will appear. The address of this EDS is set to "on" automatically.

<input type="checkbox"/>	Exit	
1.Address:		on
2.Address:		off
3.Address:		off

on Messages of this device will be displayed.

off Messages of this device will not be displayed.

### 6.6.3.8 Settings menu 8: Clock

Set the date format, date, time, and summer time changeover.



*Set the time and date on the BMS bus master. All slaves adopt this setting. The setting is synchronised every hour. The "Clock" menu setting remain stored for approx. 2 h after power supply failure.*

#### 1.Format

Set the German or American format.

d.m.y German format (day.month.year)

m-d-y American format (month-day-year)

#### 2.Date

Set the date (e.g. 20.06.2010).

### 3.Time

Set the time (e.g. 16:44).

### 4.CEST

Setting for automatic switchover to Central European Summer Time.

AUTO Automatic switchover

OFF No switchover (winter time is retained)

### 6.6.3.9 Settings menu 9: Password

Change password, activate/deactivate password.

#### 1.Password

Change password. Factory setting: 000

#### 2.Status

Activate or deactivate password protection.



*Settings can be password protected. If the password is activated (enabled), all settings can be displayed. When an attempt is made to change settings, the password entry screen appears automatically:*

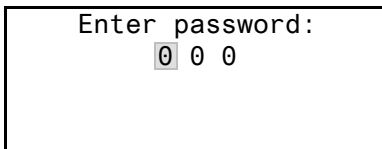

Enter password:  
0 0 0

*Once a valid password has been entered, access will be granted to settings in all menus (except the Service menu) until menu mode is exited.*

*If you can't remember your password, contact the Bender Service.*

### 6.6.3.10 Settings menu 10: Factory settings

Resets every setting to its factory setting. Factory settings are given in parentheses "( )\*" in the technical data.

### 6.6.3.11 Settings menu 11: Service

This menu is intended for Bender service employees only.

## 6.6.4 Menu 4: Control

This menu offers various options for controlling the EDS:

Exit	Exit Settings
1.TEST	Call up a test
2.RESET	Initiate a reset
3.Test communication	Test communication between the EDS... and other BMS devices.

### 6.6.4.1 Control menu 1: TEST

Call up a test (see also „Carrying out a test“ on page 39). To prevent this function being carried out inadvertently, the operator must once again confirm this entry.

### 6.6.4.2 Control menu 2: RESET

Call up a reset (see also „Resetting saved alarm messages (RESET)“ on page 40). To prevent this function being carried out inadvertently, the operator must once again confirm this entry.

### 6.6.4.3 Control menu 3: Test communication

This function enables you to test the communication between the EDS... and other BMS devices. This involves the EDS... sending an alarm message via the BMS bus until the "Test communication" function is exited. A connected evaluation device (IRDH575, MK800, COM460IP, FTC470...) must process this alarm. Select a channel for this alarm message.

Example: Alarm "insulation fault" on channel 1.

1. Select channel 1.

○ Channel disabled
Exit
1.Chan.: 1

2. Once the "↵" button is pressed, the alarm is transmitted on the BMS bus. This is indicated by the alarm display ●.

● Insulation fault
Exit
1.Chan.: 1

### 6.6.5 Menu 5: External devices

This menu can be used for setting and operating external devices connected via the BMS bus to this EDS...-D. In this way, settings at EDS...-L or other EDS...-D, for example, can be carried out.

The menu items of the external devices available via this function are displayed on the EDS...-D. Modifications of the settings of the external device are stored automatically in the external device.

After calling up this menu, the address and type of devices already stored will be displayed. The display will be updated every five minutes.

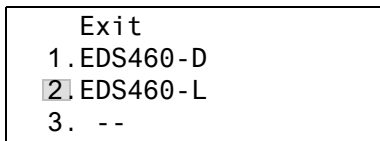

Use the Up/Down buttons to set the address of the external device and confirm with the "↵" button.



*External devices connected to the BMS bus or switched on for the first time are displayed by the EDS...-D not until a few minutes later in the external devices list. You don't need to wait for the list to appear. You can select and set the external device immediately via the address.*

The device is being searched:

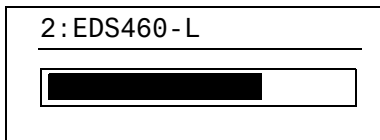

If "no access to the menu" appears, press the "ESC" button to exit the display.

Possible causes are:

- No device with this address available.
- Connected device does not support this programming function.
- Access not possible at the moment.



*The "External devices" menu is not suitable for programming this EDS... If you otherwise try to program it, the error message "Own address" will appear.*

When the device has been recognised, the EDS...-D reads the current settings of the connected device. The address and the device type will be displayed in the first line.

2:EDS460-L

Exit

1.Alarm/meas.values

2.Settings

The following menu items are displayed for the EDS...-L:

Menu item	Function	Page
Exit	Exit menu mode	-
1.Alarm/meas. values	Displays the following for each measuring channel: Alarm status, locating current $I_{\Delta S}$ , residual current $I_{\Delta}$	46
2.Settings	Settings for EDS... are made here.	49
3.Control	This menu offers various control options, such as TEST, RESET, Test communication.	59
4.Info	Information on the device. The same display is obtained by pressing the INFO button in the operating mode (refer to „Displaying standard information“ on page 41).	64

Use the Up/Down buttons to select the appropriate function or device setting and confirm with the "↵" button.

The "Settings" menu displays the following settings:

Menu item	Function	Page
Exit	Exit Settings	-
1.General	Configure the fault memory, trigger, rated frequency and type of system.	50
2.Channel	Configure the following in respect of each measuring channel: Response value, measuring transformer type, response delay, delay on release, measuring transformer monitoring, filters for systems with inverters, and alarm when the residual current has been exceeded.	51
3.Relay	Set the relay mode of operation and type of fault that you wish to cause a switching operation for the common alarm relay.	55
4.Factory setting	Resets every setting to its factory setting.	59
5.Service	For Bender service staff only.	59

### 6.6.6 Menu 6: Info

This menu displays standard information on the EDS...-D (for details refer to „Displaying standard information“ on page 41).



---

## 7. Tests and service

### 7.1 Periodic tests

The EDS system monitors itself during operation.

We recommend that the test function is called on each connected EDS... at regular intervals. A test can be called up in the following ways:

- Select the standard display, then press and hold down the "TEST" button on the EDS... front panel for at least one second
- Press an external test button connected to the EDS...
- Send a test command via the BMS bus
- EDS...-D only: Call the "TEST" function in the Control menu

Observe the applicable national and international standards which require regular testing of electrical equipment.

### 7.2 Maintenance

The EDS system does not contain any parts that require maintenance.

### 7.3 Service

Bender is happy to provide on-site service in respect of commissioning and periodic testing.

## 7.4 Troubleshooting

### 7.4.1 Display device error

An "error code" is displayed if a fault occurs. Please have this device information to hand if you should need to contact us for assistance by telephone.

Error code	Description
1	Measurement technique: Fault parameter memory (EEPROM/FLASH)
2	Measurement technique: Fault data memory (RAM)
4	Measurement technique: No boot loader available.
11	Measurement technique: Device not calibrated.
12	Measurement technique: Wrong measurement p.c.b., incorrect mounting
13	Measurement technique: Hardware error after performing a self test
71	BMS interface: No master available resp. has not been queried by a master for five minutes
72	BMS interface: Fault RS-485 interface

### Display in the event of a fault

EDS...-D	EDS...-L
Device error: xx	Er xx (alternately displayed)

xx = Error code

## 7.4.2 Device error display (channel-related)

LED "Alarm 1" lights up. The common alarm relay switches. The EDS...-D displays:

<b>Fault</b>	<b>1/1</b>
● Device error	
11	
Addr.:2	Chan.:4

Line 1: FAULT,

Alarm 1 of 1 pending alarm

Line 2: Alarm status and alarm text

○ No alarm

● Alarm

Line 3: Error code (refer to „Display device error“ on page 66)

Line 4: BMS bus address of the EDS and the measuring channel on which the alarm has occurred.

Possible causes:

- Incorrect basic programming of the EDS.
- Wrong p.c.b. assembly at four consecutive channels.
- Internal memory fault.
- Faulty channels after test.

### 7.4.3 CT connection fault display (channel-related)

LED "Alarm 1" lights up. The common alarm relay switches. The EDS...-D displays:

<b>Fault</b>	<b>1 / 1</b>
● CT fault	
Addr. : 2	Chan. : 4

The "CT fault" is displayed in the same way as „Display device error“ on page 66.

Possible causes:

- Measuring current transformer defective
- Power supply cable interrupted
- Power supply cable short-circuited

### 7.4.4 Display "peak"

System-related faults may impair the insulation fault location process. The EDS... marks the faulty channels in the "Alarm/meas.values" menu with "peak".

I (ds)	I (d)
1. Opeak	<100mA

### 7.4.5 External alarm

LED "Alarm 2" lights up. The common alarm relay switches.

Possible causes:

- Alarm message from an external device
- Device failure

## 8. Data

### 8.1 Standards

Observe the applicable national and international standards. The EDS... series meets the requirements of the following equipment standards:

- IEC 60364-4-41:2005-12:  
Low-voltage electrical installations - Part 4-41: Protection for safety - Protection against electric shock;
- IEC 61557-9:2009-01:  
Electrical safety in low voltage distribution systems up to 1000 V a.c. and 1500 V d.c. - Equipment for testing, measuring or monitoring of protective measures - Part 9: Equipment for insulation fault location in IT systems

The operating manuals for the individual system components provide you with information about the standards that apply to that particular device.

### 8.2 Approvals and certifications

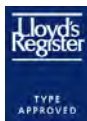

### 8.3 Technical data EDS460/490/EDS461/491

#### Insulation coordination acc. to IEC 60664-1/IEC 60664-3 for versions with a supply voltage of AC/DC 70...276 V AC 42...460 Hz

Rated insulation voltage .....	AC 250 V
Rated impulse voltage/pollution degree .....	6 kV/III
Protective separation (reinforced insulation) between .....	(A1, A2) - (k1, I... k12, R, T/R, T, A, B), (C11, C12, C14), (C21, C22, C24), (11,14), (21,24), (31,34), (41,44), (51,54), (61,64), (71,74), (81,84), (91,94), (101,104), (111,114), (121,124)
Protective separation (reinforced insulation) between .....	(C11, C12, C14) - (C21, C22, C24) - (11, 14, 21, 24, 31, 34) - (41, 44, 51, 54, 61, 64) - (71,74) - (81,84) - (91,94) - (101,104) - (111,114) - (121,124)
Dielectric test acc. to IEC 61010-1 .....	3.536 kV
Rated insulation voltage .....	AC 250 V
Rated impulse voltage/pollution degree .....	4 kV/III
Basic insulation between: .....	k1, I... k12, R, T/R, T, A, B) - (C11, C12, C14), (C21, C22, C24)
Basic insulation between: .....	(11, 14) - (21, 24) - (31, 34) - (41, 44) - (51, 54) - (61, 64)
Voltage test acc. to IEC 61010-1 .....	2.21 kV

#### Insulation coordination acc. to IEC 60664-1/IEC 60664-3 for versions with a supply voltage of DC 16...94 V, AC 42...460 Hz 16...72 V

Rated insulation voltage .....	AC 100 V
Rated impulse voltage/pollution degree .....	2,5 kV/III
Protective separation (reinforced insulation) between .....	(A1, A2) - (k1, I... k12, R, T/R, T, A, B)
Voltage test acc. to IEC 61010-1 .....	1.344 kV
Rated insulation voltage .....	AC 250 V
Rated impulse voltage/pollution degree .....	4 kV/III
Basic insulation between: .....	(A1, A2), (k1, I... k12, R, T/R, T, A, B) - (C11, C12, C14), (C21, C22, C24), (11,14), (21,24), (31,34), (41,44), (51,54), (61,64), (71,74), (81,84), (91,94), (101,104), (111,114), (121,124)
Basic insulation between: .....	(11, 14) - (21, 24) - (31, 34) - (41, 44) - (51, 54) - (61, 64)
Voltage test acc. to IEC 61010-1 .....	2.21 kV
Rated insulation voltage .....	AC 250 V
Rated impulse voltage/pollution degree .....	6 kV/III

Protective separation (reinforced insulation) between..... (C11, C12, C14) - (C21, C22, C24) - (11, 14, 21, 24, 31, 34) - (41, 44, 51, 54, 61, 64) - (71,74) - (81,84) - (91,94) - (101,104) - (111,114) - (121,124)  
 Voltage test acc. to IEC 61010-1 ..... 3.536 kV

### Supply voltage

Supply voltage  $U_S$  ..... see ordering information  
 Frequency range  $U_S$  ..... AC 42 ... 460 Hz  
 Power consumption .....  $\leq 10$  VA ( EDS460/461)  
 .....  $\leq 14$  VA (EDS490/491)

### Measuring circuit

Nominal system voltage  $U_n$  ..... see IRDH575, PGH (EDS460, EDS490)  
 ..... AC 20 ... 276 V, DC 20 ... 308 V (EDS461, EDS491)  
 External measuring current transformer type ..... W ... , WR ... , WS ... (EDS460, EDS490)  
 ..... W ... /8000, WS ... /8000 (EDS461, EDS491)  
 CT monitoring ..... on/off (off)\*  
 Load .....  $10 \Omega$  (EDS460/490),  $1.5 \text{ k}\Omega$  (EDS461/491)  
 Rated insulation voltage (measuring current transformer) ..... 800 V  
 Response sensitivity .....  $2 \dots 10$  mA (EDS460/EDS490)  
 .....  $0.2 \dots 1$  mA (EDS461/EDS491)  
 Rated frequency ..... DC, AC 50/60/400 Hz  
 EDS function measuring range .....  $1.5 \dots 50$  mA (EDS460/EDS490)  
 .....  $0.15 \dots 5$  mA (EDS461/EDS491)  
 RCM function measuring range .....  $100 \text{ mA} \dots 10$  A (EDS460/EDS490)  
 .....  $10 \text{ mA} \dots 1$  A (EDS461/EDS491)  
 Number of measuring channels (per device/system) ..... 12/1080

### Specified time

Response delay  $t_{on}$  .....  $0 \dots 24$  s  
 Delay on release  $t_{off}$  .....  $0 \dots 24$  s  
 Scanning time for all channels ..... approx.  $8 \dots 24$  s (EDS460/EDS490)  
 ..... approx.  $14 \dots 30$  s (EDS461/EDS491)  
 Response time for CT monitoring faults ..... max. 1 min.

### Displays, memory

LEDs ..... ON/ALARM (EDS4 ... -D)  
 ..... ON/ALARM/measuring channel 1 ... 12 (EDS4 ... -L)

LC display .....	backlit graphical display (EDS4...-D)
7-segment display .....	2 x 7.62 mm (EDS4...-L)
History memory .....	300 data records (EDS4...-D)
Password .....	off/0...999 (off)*
Language.....	D, GB, F (GB)*
Fault memory alarm relay .....	on/off (off)*

## Inputs/outputs

Test/reset button .....	internal/external
Cable length for external test/reset button.....	0...10 m

## Interface

Interface/protocol .....	RS-485/BMS
Baud rate .....	9.6 kbit/s
Cable length .....	0...1200 m
Recommended cable (shielded, shield on one side connected to PE) .....	J-Y(St)Y min. 2 x 0.8
Terminating resistor .....	120 Ω (0.25 W) can be connected via DIP switch
Device address, BMS bus .....	1...90 (2)*

## EDS - measuring current transformer connection

Single wire $\geq 0.75 \text{ mm}^2$ .....	0...1 m
Single wire, twisted $\geq 0.75 \text{ mm}^2$ .....	1...10 m
Shielded cable $\geq 0.5 \text{ mm}^2$ .....	10...40 m
Recommended cable (shielded, shield connected to L conductor, not earthed) .....	J-Y (St)Y min. 2 x 0.8

## Switching elements

Number .....	two relays, each with one changeover contact (EDS46.)				
.....	two relays, each with one changeover contact, 12 relays, each with one N/O contact (EDS49.)				
Operating principle .....	N/C operation/ N/O operation (N/O operation)*				
Electrical endurance under rated operating conditions, number of cycles .....	10.000				
Contact data acc. to IEC 60947-5-1					
Utilisation category .....	AC-13	AC-14	DC-12	DC-12	DC-12
Rated operational voltage.....	230 V	230 V	24 V	110 V	220 V
Rated operational current (common alarm relay).....	5 A	3 A	1 A	0.2 A	0.1 A
Rated operational current (alarm relay).....	2 A	0.5 A	5 A	0.2 A	0.1 A
Minimum contact rating.....	1 mA at AC/DC $\geq 10 \text{ V}$				



## Environment/EMC

EMC .....	IEC 61326-2-4:2006-06 Ed. 1.0
Operating temperature.....	-25 °C . . . + 55 °C
Climatic class acc. to IEC 60721	
Stationary use (IEC 60721-3-3) .....	3K5 (except condensation and formation of ice)
Transport (IEC 69721-3-2) .....	2K3 (except condensation and formation of ice)
Storage (IEC 60721-3-1) .....	1K4 (except condensation and formation of ice)
Classification of mechanical conditions acc. to IEC 60721:	
Stationary use (IEC 60721-3-3) .....	3M4
Transport (IEC 60721-3-2) .....	2M2
Storage (IEC 60721-3-1) .....	1M3

## Connection screw terminals

Connection properties:

rigid/ flexible.....	0.2 . . . 4 / 0.2 . . . 2.5 mm <sup>2</sup> /AWG 24 . . . 12
Multi-conductor connection (2 conductors with the same cross section):	
rigid, flexible .....	0.2 . . . 1.5 / 0.2 . . . 1.5 mm <sup>2</sup>
Stripping length .....	8 . . . 9 mm
Tightening torque .....	0.5 . . . 0.6 Nm

## Other

Operating mode .....	continuous operation
Position of normal use .....	any
Degree of protection DIN EN 60529, terminals.....	IP20
Enclosure material .....	polycarbonate
Flammability class .....	UL94V-0
Screw fixing.....	2 x M4
DIN rail mounting acc. to.....	IEC 60715
Weight .....	< 360 g (EDS460)
.....	< 530 g (EDS490)

( ) \* factory setting

## 8.4 Response sensitivity characteristics

The type of distribution system, system voltage, system frequency, leakage capacitance and locating current all affect the EDS system's response sensitivity.



*The value of the locating current can be set at the IRDH575 insulation monitoring device and at the PGH... locating current injector. Resulting from the type of supply system, the real locating current in AC systems is lower than the setting. The reduction factor is 0.5 in AC systems and 0.67 in 3AC systems.*

For application in AC and 3AC systems, the response value at the EDS... has to be set as follows:

<i>locating current</i>	<i>EDS</i>	<i>response value</i>
<i>10 mA</i>	<i>EDS460/490</i>	<i>&lt; 5 mA</i>
<i>1 mA</i>	<i>EDS461/491</i>	<i>&lt; 0.5 mA</i>

*For setting the response value refer to „Settings menu 2: Channel“ on page 51.*



*The response values are displayed as characteristic curves. The maximum deviation can be +/- 50 %, including the tolerances of the measuring current transformers. The characteristic curves apply to the respective nominal voltage indicated in the diagram. If the nominal voltage of the system being monitored is different from the nominal voltage shown in the diagram, the response values may change proportionally. Nominal voltages changing dynamically during operation or in case of superimposed alternating currents that deviate from the system frequency (e.g. caused by frequency converters) or superimposed direct currents may result in response values that are outside the range displayed in the diagram.*

The following characteristics are an easy way of determining a suitable response value for the insulation monitoring device and the EDS... Proceed as follows:

1. Select the characteristics (3 AC, AC, DC) that are appropriate for your type of distribution system.
2. From these, select the diagram that best matches the desired system voltage.
3. Calculate the anticipated leakage capacitance of the system being monitored. The IRDH575 displays the system leakage capacitance (press the INFO button). Apply this value to the diagram in the form of a vertical line.
4. The characteristics provided indicate the EDS system's response sensitivity when the EDS response value is set to 2 mA, 5 mA and 10 mA. Values above the relevant curve cannot be detected.
5. Select the middle characteristic for an EDS... response value of 5 mA (factory setting). Mark the system leakage capacitance  $C_e$  on the characteristic. Read off the relevant resistance  $R_e$  from the characteristic. The resistance  $R_e$  thus calculated indicates the maximum response value that can be set on the insulation monitoring device (e.g. IRDH575). If higher response values than this are set, insulation fault detection becomes unreliable. A reliable response on the part of the insulation monitoring device must be ensured before the EDS system can be started.
6. If you wish to set a higher or lower response value for the insulation monitoring device, you will need to calculate the resistance ( $R_e$ ) for the top and bottom characteristics as described under point 5. Values and characteristics that fall between the top and bottom characteristics can be roughly determined on the basis of those actually provided.
7. Set the calculated response values on the insulation monitoring device and the EDS... .

## 8.4.1 Characteristic curves EDS460/490

### 8.4.1.1 EDS460/490 characteristics for 3AC systems

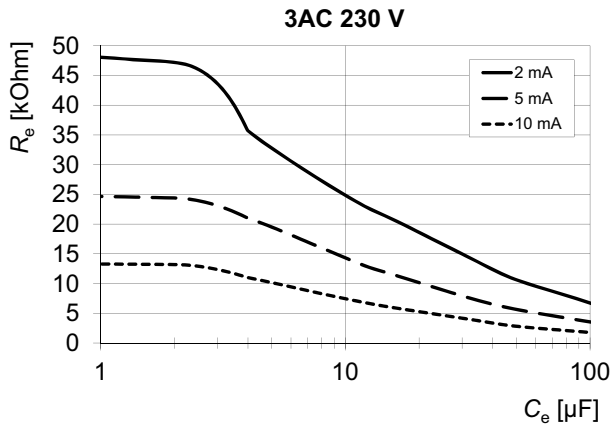

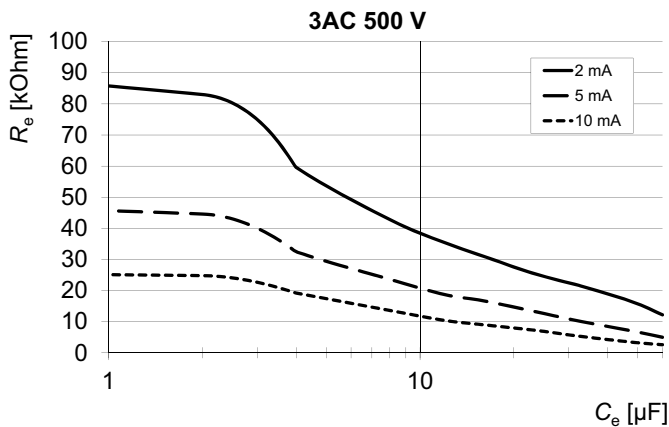
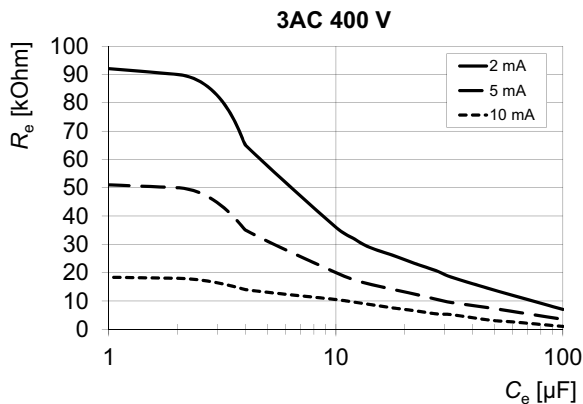

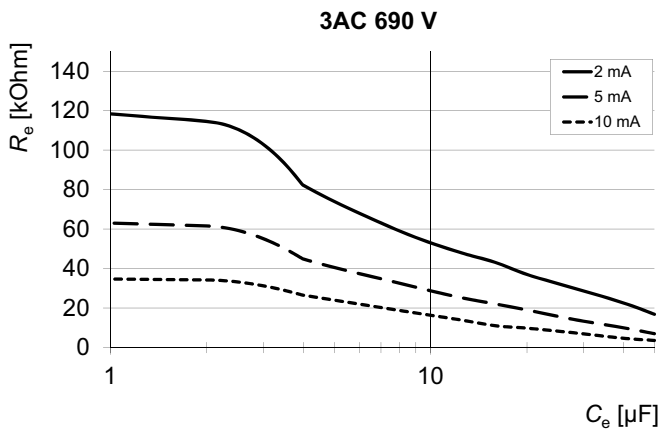

### 8.4.1.2 EDS460/490 characteristics for AC systems

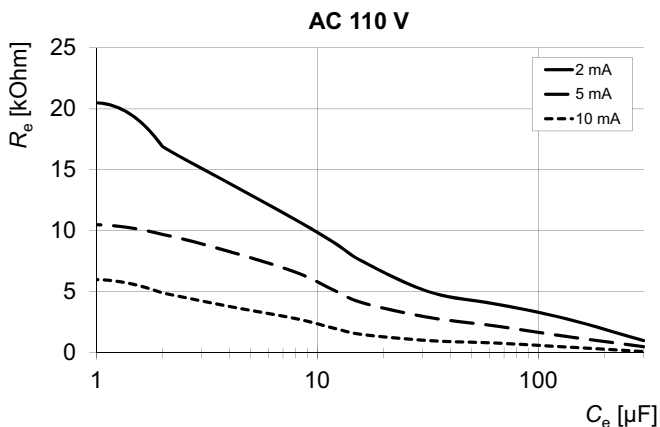
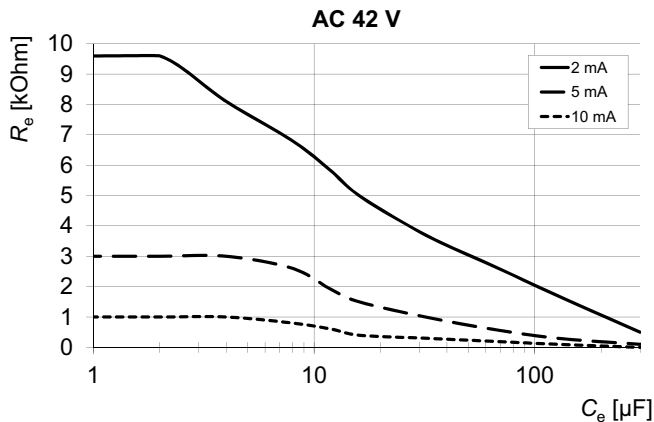



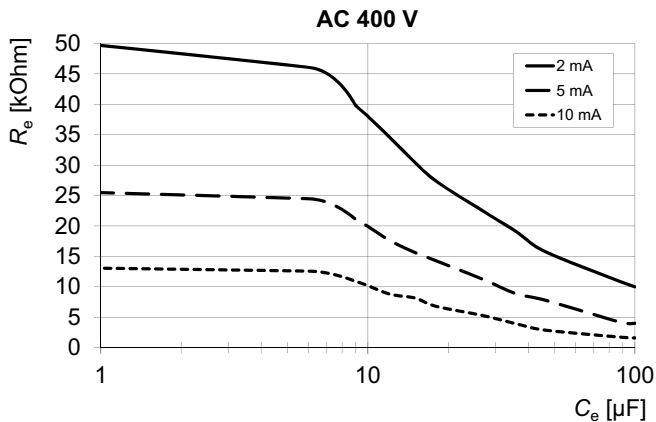
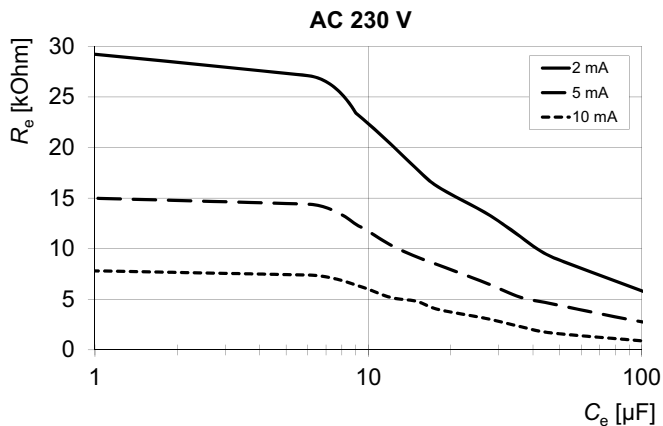

## 8.4.1.3 EDS460/490 characteristics for DC systems

## DC 24 V

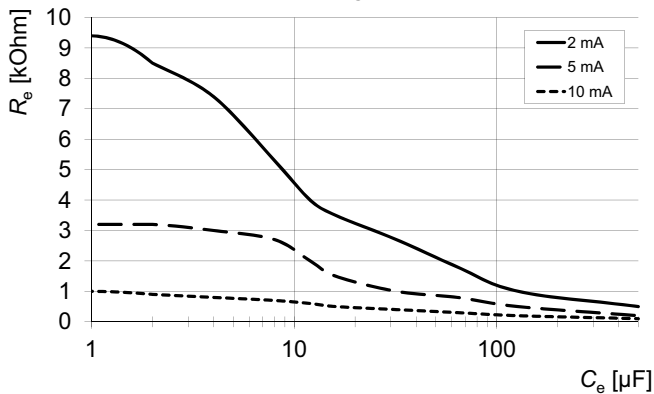

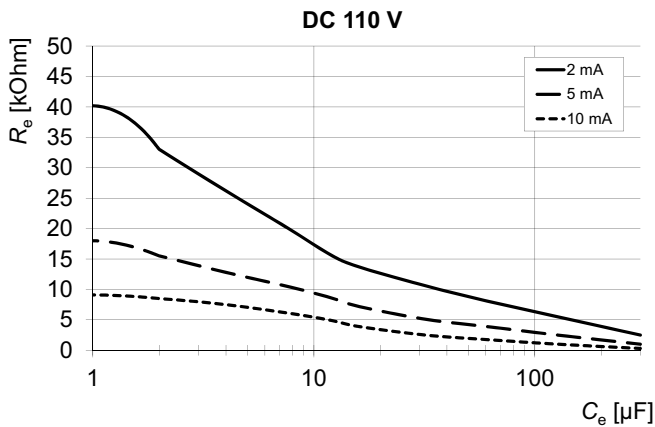
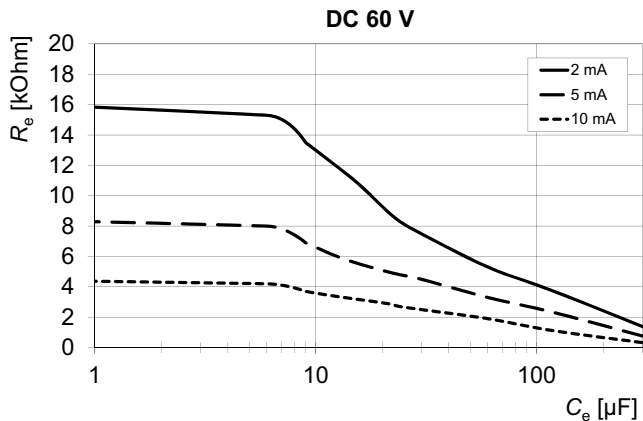

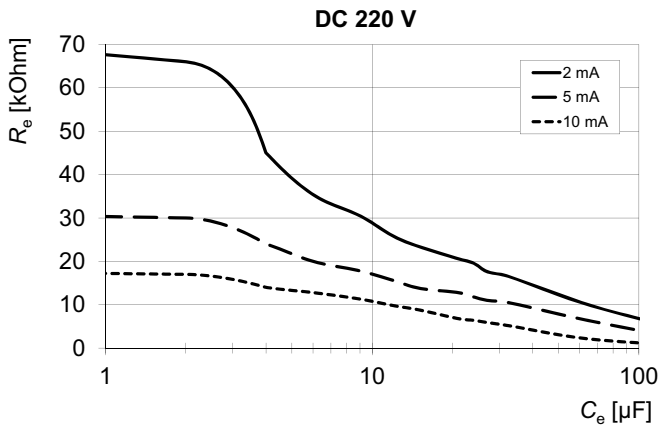

## 8.4.2 Characteristic curves EDS461/491

### 8.4.2.1 EDS461/491 characteristics for AC systems

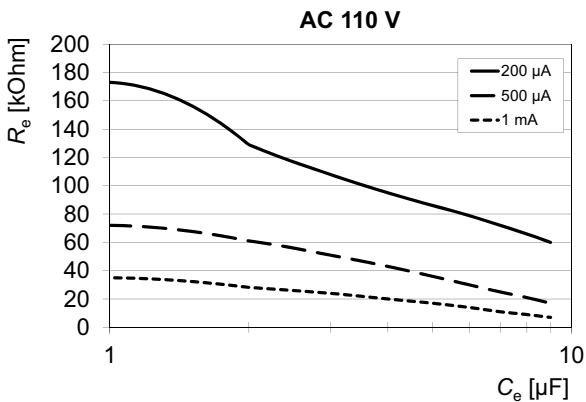
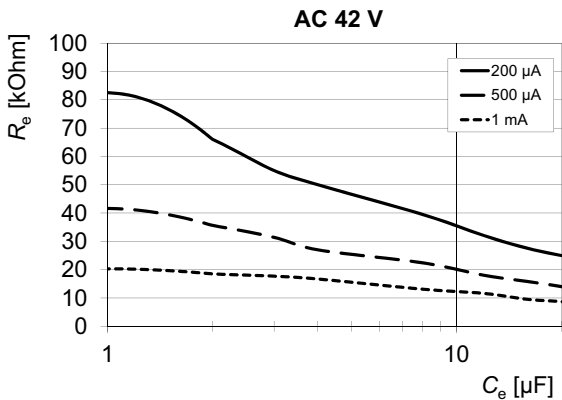

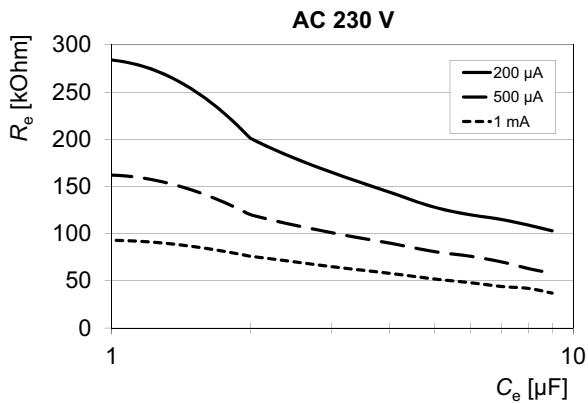

## 8.4.2.2 EDS461/491 characteristics for DC systems

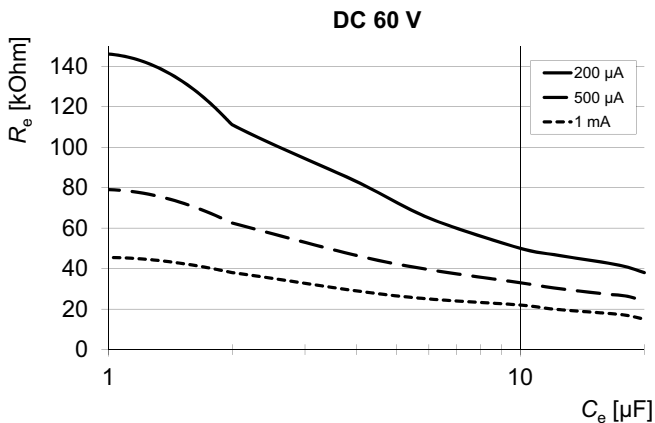
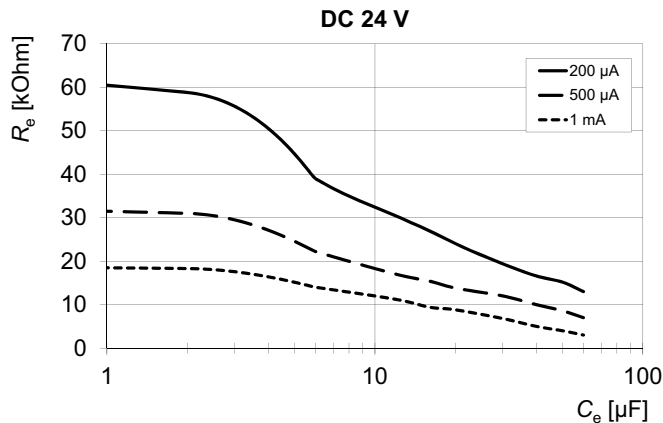

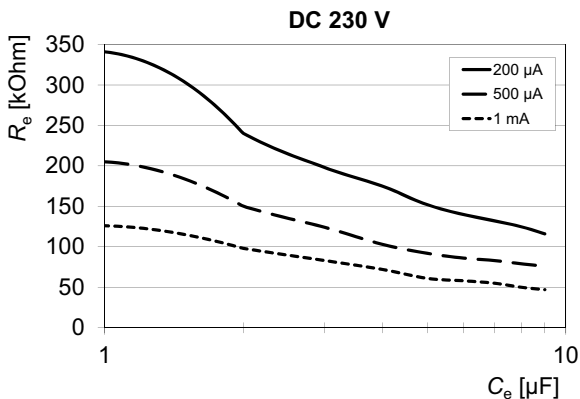
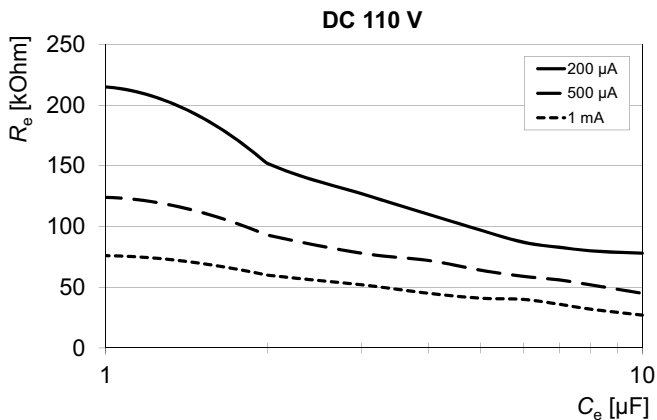



## 8.5 Ordering information

### insulation fault locators

Type	Supply voltage $U_S^*$	Response value	Art. No.
EDS460-D-1	DC 16...94 V AC 42...460 Hz 16...72 V	2...10 mA	B 9108 0001
EDS460-D-2	AC/DC 70...276 V AC 42...460 Hz	2...10 mA	B 9108 0002
EDS460-L-1	DC 16...94 V AC 42...460 Hz 16...72 V	2...10 mA	B 9108 0003
EDS460-L-2	AC/DC 70...276 V AC 42...460 Hz	2...10 mA	B 9108 0004
EDS461-D-1	DC 16...94 V AC 42...460 Hz 16...72 V	0,2...1 mA	B 9108 0005
EDS461-D-2	AC/DC 70...276 V AC 42...460 Hz	0.2...1 mA	B 9108 0006
EDS461-L-1	DC 16...94 V AC 42...460 Hz 16...72 V	0.2...1 mA	B 9108 0007
EDS461-L-2	AC/DC 70...276 V AC 42...460 Hz	0.2...1 mA	B 9108 0008
EDS490-D-1	DC 16...94 V AC 42...460 Hz 16...72 V	2...10 mA	B 9108 0009

Type	Supply voltage $U_5^*$	Response value	Art. No.
EDS490-D-2	AC/DC 70...276 V AC 42...460 Hz	2...10 mA	B 9108 0010
EDS490-L-1	DC 16...94 V AC 42...460 Hz 16...72 V	2...10 mA	B 9108 0011
EDS490-L-2	AC/DC 70...276 V AC 42...460 Hz	2...10 mA	B 9108 0012
EDS491-D-1	DC 16...94 V AC 42...460 Hz 16...72 V	0,2...1 mA	B 9108 0013
EDS491-D-2	AC/DC 70...276 V AC 42...460 Hz	0,2...1 mA	B 9108 0014
EDS491-L-1	DC 16...94 V AC 42...460 Hz 16...72 V	0,2...1 mA	B 9108 0015
EDS491-L-2	AC/DC 70...276 V AC 42...460 Hz	0,2...1 mA	B 9108 0016

\* Absolute values

## Accessories

Type	Supply voltage $U_S$	Art. No.
DI-1PSM (RS-485 interface repeater)	AC/DC 24 V $\pm 20\%$	B 9501 2044
DI-2USB (interface converter RS-485/USB) with USB cable	supplied by the USB port, no additional power supply required.	B 9501 2045
AN471 (power supply unit for DI-1 or DI-2)	AC 230 V 50/60 Hz/ AC, DC 20 V	B 924 189
Snap-on mounting W20.../35...		B 9808 0501
Snap-on mounting W60...		B 9808 0502

## Protocol converters

Type	Supply voltage $U_S^*$	Art. No.
FTC470XDP	DC 85...276 V/ AC 50...400 Hz 85...276 V	B 9506 1000
FTC470XMB	DC 85...276 V/ AC 50...400 Hz 85...276 V	B 9506 1002
FTC470XET	DC 85...276 V/ AC 50...400 Hz 85...276 V	B 9506 1001

\* Absolute values

## Measuring current transformers for EDS460/490

Bender measuring current transformers

Type	Inside diameter/mm	Type of construction	Art. No.
W20	20	circular-type	B 9808 0003
W35	35	circular-type	B 9808 0010
W60	60	circular-type	B 9808 0018
W120	120	circular-type	B 9808 0028
W210	210	circular-type	B 9808 0034
WR70x175	70 x 175	rectangular	B 9808 0609
WR115x305	115 x 305	rectangular	B 9808 0610
WS20x30	20 x 30	split-core	B 9808 0601
WS50x80	50 x 80	split-core	B 9808 0603
WS80x80	80 x 80	split-core	B 9808 0605
WS80x120	80 x 120	split-core	B 9808 0606
WS80x160	80 x 160	split-core	B 9808 0608

## Alternative measuring current transformers from the Bender range

Type	Inside diameter/mm	Type of construction	Art. No.
W10/600	10	circular-type	B 911 761
W0-S20	20	circular-type	B 911 787
W1-S35	35	circular-type	B 911 731
W2-S70	70	circular-type	B 911 732
W3-S105	105	circular-type	B 911 733
W4-S140	140	circular-type	B 911 734
W5-S210	210	circular-type	B 911 735
WR 70x175S	70x175	rectangular	B 911 738
WR 115x305S	115x305	rectangular	B 911 739
WR 150x350S	150x350	rectangular	B 911 740
WR 200x500S	200x500	rectangular	B 911 763
WS 50x80S	50x80	split-core	B 911 741
WS 80x80S	80x80	split-core	B 911 742
WS 80x120S	80x120	split-core	B 911 743
WS 80x160S	80x160	split-core	B 911 755

## Measuring current transformers for EDS461/491

Bender measuring current transformers

Type	Inside diameter/mm	Type of construction	Art. No.
W20-8000	20	circular-type	B 9808 0009
W35-8000	35	circular-type	B 9808 0017
W60-8000	60	circular-type	B 9808 0027
WS20x30-8000	20 x 30	split-core	B 9808 0602
WS50x80-8000	50 x 80	split-core	B 9808 0604

Alternative measuring current transformers from the Bender range

Type	Inside diameter/mm	Type of construction	Art. No.
W10/8000	10	circular-type	B 911 759
W1-35/8000	35	circular-type	B 911 756
WS20x30/8000	20 x 30	split-core	B 911 764
WS50x80/8000	50 x 80	split-core	B 911 757
W10/8000-6	10	circular, 6x	B 911 900







# INDEX

## A

- ALARM 37
- Alarm status 38, 46, 67
- Areas 13

## B

- Bender service 59
- Bus address 56

## C

- Checking the device function 39
- Commissioning 31, 65
- Connection example 29
- Control 59
- CT monitoring 54
- CT type 52

## D

- Damage in transit 21
- Date 57
- Delay on release 53

## E

- Environment, cold 21
- Error code 66

## F

- Factory settings 59
- Fault memory 50

- Fuses 22

## H

- History memory 48

## I

- Intended use 9

## L

- Language 56

## M

- Main menu 42, 43
- Maintenance 65
- Menu mode 42

## N

- Nominal insulation voltage 22

## O

- Operating mode 37
- Ordering information 89
- Overview diagram 44

## P

- Password 58
- Peak 68
- Personnel 10

## **R**

- Rated frequency 51
- Relay mode of operation 55
- RESET 40
- Residual current 46
- Response delay 52

## **S**

- Service 65
- Shielded conductors 29
- Standard information 41, 64
- Standards 65
- Summer time 58
- Switching on 31, 32
- System components 7

## **T**

- Test communication 59
- Test function 65
- Time 58

## **U**

- Unpacking 21

## **W**

- Wiring diagram 25, 27



**optec**  
energie ist messbar

Optec AG | Eichen-Zellen-Strasse 14 | 71482 Ditzingen | Germany

Telefon: +41 44 823 07 70 | Telefax: +41 44 823 07 77  
E-Mail: [info@optec.ch](mailto:info@optec.ch) | [www.optec.ch](http://www.optec.ch)



**Bender GmbH & Co. KG**

Londorfer Str. 65 • 35305 Gruenberg • Germany

Postfach 1161 • 35301 Gruenberg • Germany

Tel.: +49 6401 807-0

Fax: +49 6401 807-259

E-Mail: [info@bender.de](mailto:info@bender.de)

[www.bender.de](http://www.bender.de)



Photos: Bender archive

**BENDER Group**