



VME420

Voltage and frequency monitor

for monitoring AC/DC systems of 0...300 V, 15...460 Hz

for undervoltage, overvoltage, underfrequency, overfrequency





Bender GmbH & Co. KG

P.O. Box 1161 • 35301 Gruenberg • Germany

Londorfer Strasse 65 • 35305 Gruenberg • Germany

Tel.: +49 6401 807-0 • Fax: +49 6401 807-259

E-Mail: info@bender.de • www.bender.de

© Bender GmbH & Co. KG

All rights reserved.

Reprinting only with permission of the publisher.

Subject to change!

Photos: Bender archives

Table of Contents

1. Important information	5
1.1 How to use this manual	5
1.2 Technical support: service and support	6
1.2.1 First level support	6
1.2.2 Repair service	6
1.2.3 Field service	7
1.3 Training courses	8
1.4 Delivery conditions	8
1.5 Inspection, transport and storage	8
1.6 Warranty and liability	9
1.7 Disposal	10
2. Safety instructions	11
2.1 General safety instructions	11
2.2 Work activities on electrical installations	11
2.3 Intended use	12
3. Function	13
3.1 Device features	13
3.2 Fast commissioning for $U_n = 230\text{ V}$	14
3.3 Function	15
3.4 Preset function	15
3.5 Automatic self test	16
3.6 Manual self test	16
3.7 Functional fault	16
3.8 Fault memory	16
3.9 Assigning alarms to the alarm relays K/K2	17
3.10 Time delays t , t_{on} and t_{off}	17
3.11 Password protection (on, OFF)	17

3.12	Factory setting FAC	18
3.13	Erasable history memory	18
3.14	Alarm LEDs show which relay is in the alarm state	18
3.15	Starting a device using a simulated alarm S.AL	18
3.16	Frequency alarm in case of measuring voltage failure	20
4.	Installation and connection	21
5.	Operation and setting	23
5.1	Display elements in use	23
5.2	Function of the operating elements	24
5.3	Menu structure	25
5.4	Display in standard mode	27
5.5	Display in menu mode	28
5.5.1	Setting: response values for under-, overvoltage and hysteresis	30
5.5.2	Setting: response values for under-, overfrequency, hysteresis	32
5.5.3	Setting: fault memory and operating principle (alarm relays)	33
5.5.4	Assigning alarm categories to the alarm relays	35
5.5.5	Setting the time delays	37
5.5.6	Factory setting and password protection	38
5.5.7	Restoring factory settings	40
5.5.8	Manual activation of the preset function	40
5.5.9	Device information interrogation	41
5.5.10	History memory interrogation	41
5.6	Preset function/ factory setting	41
5.7	Commissioning	42
6.	Technical data VME420... ..	43
6.1	Data in tabular form	43
6.2	Standards, approvals and certifications	47
6.3	Ordering information	47
6.4	User settings (overview)	48
INDEX	49

1. Important information

1.1 How to use this manual



*This manual is intended for **qualified personnel** working in electrical engineering and electronics!*

Always keep this manual within easy reach for future reference.

To make it easier for you to understand and revisit certain sections in this manual, we have used symbols to identify important instructions and information. The meaning of these symbols is explained below:



DANGER

*This signal word indicates that there is a **high risk of danger** that will result in **electrocution** or **serious injury** if not avoided.*



WARNING

*This signal word indicates a **medium risk of danger** that can lead to **death** or **serious injury** if not avoided.*



CAUTION

*This signal word indicates a **low level risk** that can result in **minor** or **moderate injury or damage to property** if not avoided.*



*This symbol denotes information intended to assist the user in making **optimum use** of the product.*

This manual has been compiled with great care. It might nevertheless contain errors and mistakes. Bender cannot accept any liability for injury to persons or damage to property resulting from errors or mistakes in this manual.

1.2 Technical support: service and support

For commissioning and troubleshooting Bender offers you:

1.2.1 First level support

Technical support by phone or e-mail for all Bender products

- Questions concerning specific customer applications
- Commissioning
- Troubleshooting

Telephone: +49 6401 807-760*
Fax: +49 6401 807-259
In Germany only: 0700BenderHelp (Tel. and Fax)
E-mail: support@bender-service.de

1.2.2 Repair service

Repair, calibration, update and replacement service for Bender products

- Repairing, calibrating, testing and analysing Bender products
- Hardware and software update for Bender devices
- Delivery of replacement devices in the event of faulty or incorrectly delivered Bender devices
- Extended guarantee for Bender devices, which includes an in-house repair service or replacement devices at no extra cost

Telephone: +49 6401 807-780** (technical issues)
+49 6401 807-784**, -785** (sales)
Fax: +49 6401 807-789
E-mail: repair@bender-service.de

Please send the devices for **repair** to the following address:

Bender GmbH, Repair-Service,
Londorfer Str. 65,
35305 Gruenberg

1.2.3 Field service

On-site service for all Bender products

- Commissioning, configuring, maintenance, troubleshooting of Bender products
- Analysis of the electrical installation in the building (power quality test, EMC test, thermography)
- Training courses for customers

Telephone: +49 6401 807-752**, -762 **(technical issues)
+49 6401 807-753** (sales)

Fax: +49 6401 807-759

E-mail: fieldservice@bender-service.de

Internet: www.bender-de.com

*Available from 7.00 a.m. to 8.00 p.m. 365 days a year (CET/UTC+1)

**Mo-Thu 7.00 a.m. - 8.00 p.m., Fr 7.00 a.m. - 13.00 p.m

1.3 Training courses

Bender is happy to provide training regarding the use of test equipment. The dates of training courses and workshops can be found on the Internet at www.bender-de.com -> Know-how -> Seminars.

1.4 Delivery conditions

Bender sale and delivery conditions apply.

For software products the "Softwareklausel zur Überlassung von Standard-Software als Teil von Lieferungen, Ergänzung und Änderung der Allgemeinen Lieferbedingungen für Erzeugnisse und Leistungen der Elektroindustrie" (software clause in respect of the licensing of standard software as part of deliveries, modifications and changes to general delivery conditions for products and services in the electrical industry) set out by the ZVEI (Zentralverband Elektrotechnik- und Elektronikindustrie e. V.) (German Electrical and Electronic Manufacturer's Association) also applies.

Sale and delivery conditions can be obtained from Bender in printed or electronic format.

1.5 Inspection, transport and storage

Inspect the dispatch and equipment packaging for damage, and compare the contents of the package with the delivery documents. In the event of damage in transit, please contact Bender immediately.

The devices must only be stored in areas where they are protected from dust, damp, and spray and dripping water, and in which the specified storage temperatures can be ensured.

1.6 Warranty and liability

Warranty and liability claims in the event of injury to persons or damage to property are excluded if they can be attributed to one or more of the following causes:

- Improper use of the device.
- Incorrect mounting, commissioning, operation and maintenance of the device.
- Failure to observe the instructions in this operating manual regarding transport, commissioning, operation and maintenance of the device.
- Unauthorised changes to the device made by parties other than the manufacturer.
- Non-observance of technical data.
- Repairs carried out incorrectly and the use of replacement parts or accessories not approved by the manufacturer.
- Catastrophes caused by external influences and force majeure.
- Mounting and installation with device combinations not recommended by the manufacturer.

This operating manual, especially the safety instructions, must be observed by all personnel working on the device. Furthermore, the rules and regulations that apply for accident prevention at the place of use must be observed.

1.7 Disposal

Abide by the national regulations and laws governing the disposal of this device. Ask your supplier if you are not sure how to dispose of the old equipment.

The directive on waste electrical and electronic equipment (WEEE directive) and the directive on the restriction of certain hazardous substances in electrical and electronic equipment (RoHS directive) apply in the European Community. In Germany, these policies are implemented through the "Electrical and Electronic Equipment Act" (ElektroG). According to this, the following applies:

- Electrical and electronic equipment are not part of household waste.
- Batteries and accumulators are not part of household waste and must be disposed of in accordance with the regulations.
- Old electrical and electronic equipment from users other than private households which was introduced to the market after 13 August 2005 must be taken back by the manufacturer and disposed of properly.

For more information on the disposal of Bender devices, refer to our homepage at www.bender-de.com -> Service & support.

2. Safety instructions

2.1 General safety instructions

Part of the device documentation in addition to this manual is the enclosed "Safety instructions for Bender products".

2.2 Work activities on electrical installations



Only **qualified personnel** are permitted to carry out the work necessary to install, commission and run a device or system.



DANGER

Risk of electrocution due to electric shock!

Touching live parts of the system carries the risk of:

- An electric shock
- Damage to the electrical installation
- Destruction of the device

Before installing and connecting the device, make sure that the *installation* has been **de-energised. Observe the rules for working on electrical installations.**

If the device is used outside the Federal Republic of Germany, the applicable local standards and regulations must be complied with. The European standard EN 50110 can be used as a guide.

2.3 Intended use

The voltage monitor VME420 monitors AC/DC systems in the frequency range DC/15...460 Hz for undervoltage, overvoltage, underfrequency and overfrequency. The devices are designed for the nominal voltage range $U_n = 0 \dots 300$ V. Separate supply voltage U_s is required.

In order to meet the requirements of the applicable standards, customised parameter settings must be made on the equipment in order to adapt it to local equipment and operating conditions. Please heed the limits of the range of application indicated in the technical data.

Any use other than that described in this manual is regarded as improper.

3. Function

3.1 Device features

- Undervoltage and overvoltage monitoring of AC/DC systems 0...300 V in the frequency range DC/15...460 Hz
- Preset function: Automatic response value setting for undervoltage and overvoltage, $< U$ and $> U$ as well as for underfrequency and overfrequency $< f$ and $> f$.
- Voltage and frequency monitoring with window discriminator function, $< U$ and $> U$ as well as $< f$ and $> f$.
- Indication of the system frequency f
- Start-up delay, response delay and delay on release
- Adjustable switching hysteresis for U and f
- r.m.s. value measurement AC + DC
- Measured value display via multi-functional LC display
- Alarm indication via LEDs (AL1, AL2) and changeover contacts (K1, K2)
- N/C operation or N/O operation selectable
- Password protection against unauthorised parameter changing
- Fault memory can be deactivated. In the "con" mode, all alarm parameters remain stored on failure of the supply voltage.
- Start-up of the device with or without simulated alarm message
- Frequency alarm behaviour in case of measuring voltage failure can be parameterised

3.2 Fast commissioning for $U_n = 230\text{ V}$

If you are already familiar with voltage monitors, you can reduce the time for commissioning and connection using this brief description.

1. Check that the system being monitored is operated with a nominal voltage of $U_n = 230\text{ V}$ and 50 Hz. This is the precondition for an automatic setting of the response values (Preset) after the first connection to the nominal voltage.
2. Make sure that the voltage monitor is in the delivery status (factory setting has not been changed). In case of doubt, restore the factory setting (page 40).
3. When the conditions 1 and 2 are satisfied, you can connect the voltage monitor to the three-phase system to be monitored according to the wiring diagram (page 22). The following predefined response values will be set automatically:

VME420			
U_n, f_n	Preset operating range	Response value $< U, < f$	Response value $> U, > f$
230 V	196...253 V	196 V	253 V
50 Hz	47...53 Hz	49 Hz	51 Hz

4. The currently measured voltage between the terminals U1/+ and U2/- appears on the display. In addition, you can query the system frequency f using the Up and Down key when AC voltage is applied.

For detailed information about the preset function and other voltage ranges refer to page 15; page 41 provides a summary of all factory settings.

If you want to reset the voltage monitors to factory settings, refer to page 40.

3.3 Function

Once the supply voltage is applied, the start-up delay "t" begins. Measured values changing during this time do not influence the switching state of the alarm relays.

The devices provide two separately adjustable measuring channels (overvoltage/undervoltage). If the measured value drops below the response value Alarm 2 or exceeds the response value (Alarm 1), the set response delays "ton 1/2" start. Once the response delay has elapsed, the alarm relays switch and the alarm LEDs light up. If the measuring value exceeds or falls below the release value (response value plus hysteresis) after the alarm relays have switched, the selected delay on release "t_{off}" starts. Once "t_{off}" has elapsed, the alarm relays switch back to their initial position. If the fault memory is enabled, the alarm relays remain in alarm state until the reset button R is pressed.

3.4 Preset function

After connecting the system to be monitored for the first time, the response values for overvoltage and undervoltage (Alarm 1/2) are automatically set once to:

Response value overvoltage ($> U$): $1.1 U_n$

Response value undervoltage ($< U$): $0.85 U_n$

Response value overfrequency ($> f$) at 16.7 Hz, 50 Hz, 60 Hz: $f_n + 1$ Hz

Response value overfrequency ($> f$) at 400 Hz: $f_n + 1$ Hz

Response value underfrequency ($< f$) at 16.7 Hz, 50 Hz, 60 Hz: $f_n - 1$ Hz

Response value underfrequency ($< f$) at 400 Hz: $f_n - 1$ Hz

Preset VME420			
U_n	Preset operating range	Response value $< U$	Response value $> U$
230 V	196...253 V	196 V	253 V
120 V	102...132 V	102 V	132 V
60 V	51...66 V	51 V	66 V
24 V	20.4...26.4 V	20.4 V	26.4 V

If the measured voltage is not within the preset operating range listed in the table, the message "AL not Set" appears on the display. Therefore it is necessary to set the response values for Alarm 1 (AL1) and Alarm 2 (AL2) manually. A detailed description of the process is given in the chapter "parameter setting".

After restoring the factory settings, the preset function is automatically active again.

During operation, the preset function can be started manually via the menu SEt.

3.5 Automatic self test

The device automatically carries out a self test after connection to the system to be monitored and later every hour. During the self test internal functional faults are detected and appear in form of an error code on the display. The alarm relays are not checked during this test.

3.6 Manual self test

After pressing the internal test button for > 1.5 s, a self test is performed by the device. During this test, internal functional faults are determined and appear in form of an error code on the display. The alarm relays are not checked during this test.

While the test button T is pressed and held down, all device-related display elements appear on the display.

3.7 Functional fault

If there is an internal functional fault, all three LEDs flash. The display shows an error code (E01...E32). In such a case please contact the Bender Service.

3.8 Fault memory

The fault memory can be activated, deactivated or can be set to continuous mode (con). If the fault memory is set to "con" mode, the alarm parameters remain stored even on failure of the supply voltage.

3.9 Assigning alarms to the alarm relays K/K2

Different alarm categories can be assigned to the alarm relays K1/K2 via the menu "out".

3.10 Time delays t , t_{on} and t_{off}

The times t , t_{on} and t_{off} described below delay the output of alarms via LEDs and relays.

Start-up delay t

Once the supply voltage U_s has been switched on, the alarm indication is delayed by the preset time t (0...300 s).

Response delay t_{on}

When the value drops below or exceeds the response value, the voltage monitor requires the response time t_{an} until the alarm is activated.

A preset response delay t_{on} (0...300 s) adds up to the device-related operating time t_{ae} and delays alarm signalling (total delay time $t_{\text{an}} = t_{\text{ae}} + t_{\text{on}}$).

If the fault no longer exists during the response delay, the alarm signal drops out.

Delay on release t_{off}

If the alarm no longer exists during the response delay and the fault memory is deactivated, the alarm LEDs will go out and the alarm relays switch back to their initial position. The delay on release (0...300 s) serves to maintain the alarm state signal for the set duration.

3.11 Password protection (on, OFF)

With the password protection activated (on), settings are only possible after entering the correct password (0...999). If you cannot operate your device because you cannot remember your password, please contact info@Bender-service.com.

3.12 Factory setting FAC

After activating the factory setting, all settings previously changed are reset to delivery status. In addition, the preset function allows automatic adaptation of the response values in relation to the nominal voltage U_n .

3.13 Erasable history memory

The first alarm value that occurs will be stored in this memory. Subsequent alarms do not overwrite this "old" value. The memory can be cleared using the Clr key in the menu HiS.

3.14 Alarm LEDs show which relay is in the alarm state

When the menu item **LEd**  is activated, the alarm LED AL1 indicates that K1 is in the alarm state. When AL2 lights up, K2 is in the alarm state. An alarm relay cannot switch to the alarm state unless an alarm category has been assigned to it.

When the menu item **LEd**  is deactivated, AL1 signals overvoltage, AL2 signals undervoltage, both LEDs AL1 and AL2 light up in case of frequency alarm.

For details about alarm category assignment to the respective relays refer to the submenu out description on page 26.

3.15 Starting a device using a simulated alarm S.AL

If the menu item S.AL has been activated in the out menu, K1 resp. K2 switches back to the alarm state once the supply voltage is applied. This alarm state is maintained for the set duration $t + t_{on1}$. Once this time has elapsed, K1 resp. K2 switches back to the initial position provided that no fault is detected at the measuring input.

The following diagrams show the effect of a fault during a simulated alarm.

Faults at the measuring input and the resulting condition of the alarm relay K1 (K2) are shown as a hatched area.

The fault for K1 shown in the time diagram below, by way of example, has started during the S.AL phase:

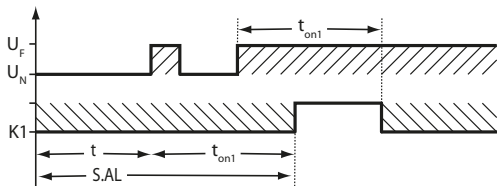

The fault for K1 shown in the time diagram below, by way of example, started when the S.AL phase has elapsed:

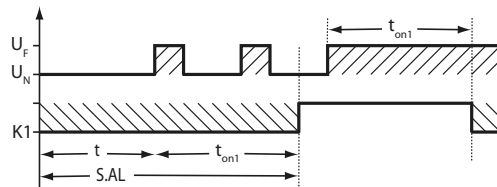

3.16 Frequency alarm in case of measuring voltage failure

(Menu -> AL -> <U Hz)

If the voltage of the monitored system falls to the point where the frequency can no longer be determined, this parameter is used to set how the frequency alarm should behave.

On: The device sets the underfrequency/overfrequency alarm (factory setting).

Off: The device does not set a frequency alarm.

Note for <U Hz = Off:



If there are **transients** (depending on circuit breakers and system parameters) when the voltage of the monitored system fails or returns, the device may still briefly output a frequency alarm.

To avoid this behaviour, the relay to which frequency alarms are assigned must be delayed by means of t_{on1} or t_{on2} and t_{off} .



If the frequency of the monitored system slowly returns (e.g. due to a starting generator), the frequency monitoring only becomes active when the frequency is within specified limits (≥ 10 Hz).

4. Installation and connection



Only **qualified personnel** are permitted to carry out the work necessary to install, commission and run a device or system.



DANGER

Risk of electrocution due to electric shock!

Touching live parts of the system carries the risk of:

- An electric shock
- Damage to the electrical installation
- Destruction of the device

Before installing and connecting the device, make sure that the installation has been de-energised. Observe the rules for working on electrical installations.

General dimension diagram and drawing for screw fixing

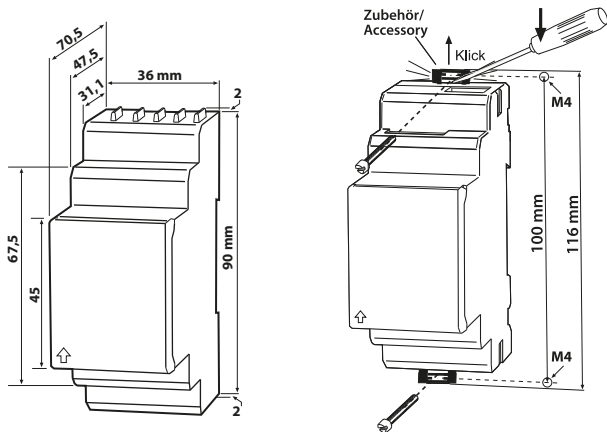

The front plate cover is easy to open at the lower part identified by an arrow.

1. DIN rail mounting:

Snap the rear mounting clip of the device into place in such a way that a safe and tight fit is ensured.

Screw fixing:

Use a tool to move the rear mounting clips (a second mounting clip is required, see ordering information) to a position that it projects beyond the enclosure. Then fix the device using two M4 screws.

2. Wiring

Connect the device according the wiring diagram.

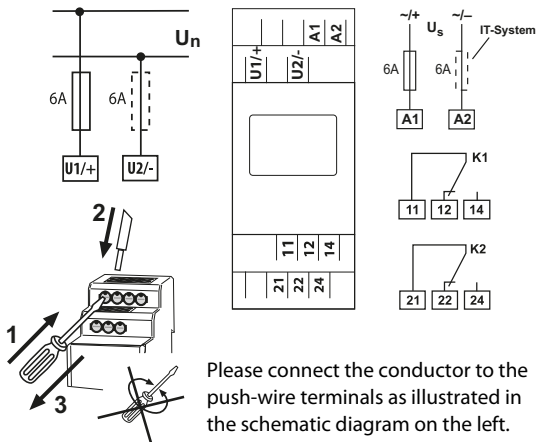



Terminal	Connections
A1, A2	Connection of supply voltage U_s
U1/+, U2/-	Connection to the system to be monitored
11, 12, 14	Alarm relay K1
21, 22, 24	Alarm relay K2



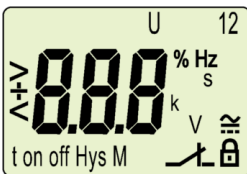

5. Operation and setting

5.1 Display elements in use

The meaning of the display elements in use is listed in detail in the table below.

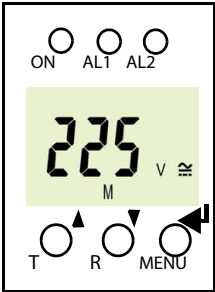
Display elements	Element	Function
	< U, > U	Undervoltage (Alarm 2), overvoltage (Alarm 1)
	R1, r1, R2, r2	Alarm relay K1, Alarm relay K2
	U Hys, %	Response value hysteresis as %
	< Hz, > Hz	Underfrequency (AL1 and AL2) Overfrequency (AL1 and AL2)
	Hz Hys	Frequency response value hysteresis as Hz
	ton1, ton2, T, toff	Response delay t_{on1} (K1), Response delay t_{on2} (K2) Start-up delay t , Delay on release t_{off} for K1, K2
	M	Fault memory active
		Operating mode of the relays K1, K2; resp. LEDs AL1/AL2 indicate the alarm state of K1/K2
		Password protection active

5.2 Function of the operating elements



Device front	Element	Function
	ON	Power On LED, green
	AL1, AL2	Menu item LED  deactivated: LED Alarm 1 lights (yellow): Response value > U reached LED Alarm 2 lights (yellow): Res- ponse value < U reached
	AL1 and AL2	Menu item LED  deactivated: Both LEDs light when the fre- quency response values > Hz or < Hz are reached.
	AL1, AL2	Menu item LED  activated: LED Alarm 1 lights (yellow): K1 signals an arbitrary alarm LED Alarm 2 lights (yellow): K2 signals an arbitrary alarm
	225 V, M	Display in standard mode: $U_n =$ 225 V; Fault memory active
	T, ▲	Test button (> 1.5 s): Indication of the useable display elements, starting a self test; Up key (< 1.5 s): Menu items/values
	R, ▼	Reset button (> 1.5 s): Deleting the fault memory; Down key (< 1.5 s): Menu items/values

Device front	Element	Function
	MENU, 	MENU key (> 1.5 s): Starting the menu mode; Enter key (< 1.5 s): Confirm menu item, submenu item and value. Enter key (> 1.5 s): Back to the next higher menu level.

5.3 Menu structure

All adjustable parameters are listed in the columns menu item and adjustable parameters. A display-like representation is used to illustrate the parameters in the column menu item. Different alarm categories can be assigned to the alarm relays K1, K2 via the submenus r1, r2. This is done by activation or deactivation of the respective function.

Menu	Sub Menu	Menu item	Activation	Adjustable parameter
AL (response - values)		< U	ON	Undervoltage (Alarm 2)
		> U	ON	overvoltage (Alarm 1)
		U Hys	-	Hysteresis < U / > U
		< Hz	OFF	Underfrequency
		> Hz	OFF	Overfrequency
		Hz Hys	-	Hysteresis, frequency
		<U Hz	ON	Frequency alarm behaviour in case of measuring voltage failure

Menu	Sub Menu	Menu item	Activation	Adjustable parameter	
out (output control)	→	M	ON	Fault memory (on, con, off)	
		 1	-	Operating mode K1 (n.o.)	
		 2	-	Operating mode K2 (n.c.)	
		 LED	OFF	LEDs signal relay in alarm state	
	r1 (K1: assignment alarm category)	1 Err	OFF	Device error at K1	
		r1 < U	OFF	Undervoltage K1	
		r1 > U	ON	Overvoltage K1	
		r1 < Hz	ON	Underfrequency K1	
		r1 > Hz	ON	Overfrequency K1	
		1 S.AL	OFF	Start with alarm during $t + t_{on1}$	
	r2 (K2: assignment alarm category)	2 Err	OFF	Device error K2	
		r2 < U	ON	Undervoltage K2	
		r2 > U	OFF	Overvoltage K2	
		r2 < Hz	ON	Underfrequency K2	
		r2 > Hz	ON	Overfrequency K2	
		2 S.AL	OFF	Start with alarm during $t + t_{on2}$	
	t (timing check)	→	ton1	-	Response delay K1
			ton2	-	Response delay K2
			T	-	Starting delay
			toff	-	Delay on release K1/K2

Menu	Sub Menu	Menu item	Activation	Adjustable parameter
Set (device control)	→		OFF	Parameter setting via password
		FAC	-	Re-establish factory settings
		PrE	-	Manual preset
		SYS	-	Function blocked
InF	→		-	Display hard / software version
HiS	→	Clr	-	History memory for the first alarm value, erasable

5.4 Display in standard mode

By default, the display indicates the voltage across the terminals U1/+ and U2/- . In order to change the default display, confirm your choice with Enter.



In the standard mode, the currently measured voltage or frequency can be displayed using the Up and Down keys.

5.5 Display in menu mode

Menu item	Adjustable parameter
AL	Interrogate and adjust response values: <ul style="list-style-type: none"> - Undervoltage: < U (AL2) - Overvoltage: > U (AL1) - Hysteresis of the response values: Hys U - Underfrequency: < Hz (AL1 and AL2) - Overfrequency: > Hz (AL1 and AL2) - Hysteresis of the frequency response values: Hys Hz - Frequency alarm behaviour in case of measuring voltage failure: <U Hz
out	Configuration of the fault memory and the alarm relays: <ul style="list-style-type: none"> - Activate/deactivate the fault memory or to set to con mode - Select N/O operation (n.o.) or N/C operation (n.c.) individually for each K1/K2 - Assign the alarm categories undercurrent, overcurrent, underfrequency, overfrequency or device error individually to each K1/K2 (1, r1 / 2, r2) - AL1/AL2 indicate that K1/K2 are in alarm state (LEd)
t	Delay setting: <ul style="list-style-type: none"> - Response delay t_{on1}/t_{on2} - Start-up delay t - Delay on release t_{off} (LED, relay)
Set	Parameter setting for device control: <ul style="list-style-type: none"> - Enabling/disabling password protection, changing the password - Restoring factory settings; - Activating preset function PrE; - Service menu SyS blocked
InF	Interrogate hard and software version
HiS	Interrogate the first stored alarm value
ESC	Move to the next higher menu level (back)

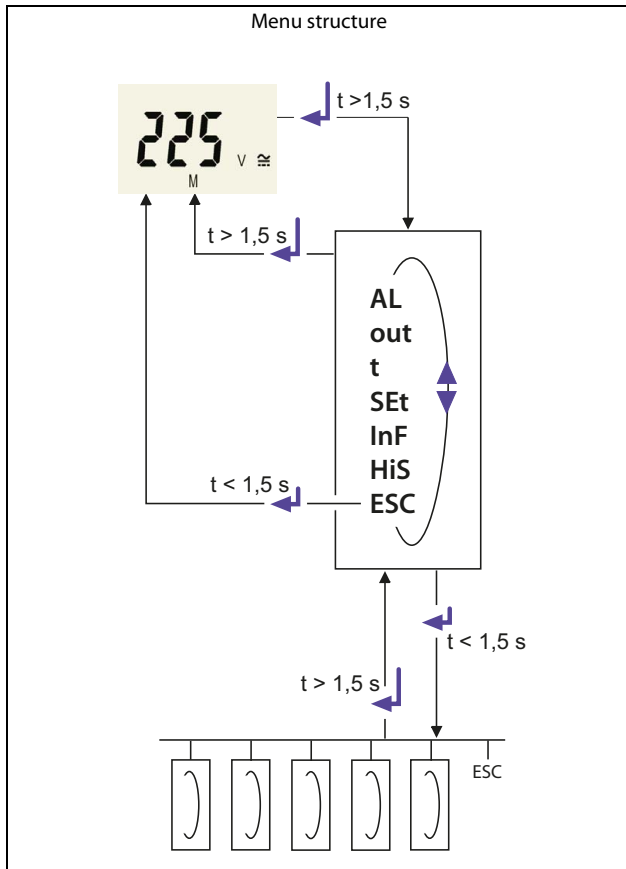

Parameter settings

An example is given below on how to change the alarm response value for overvoltage $> U$. Proceed as follows:

1. Press the MENU/Enter key for more than 1.5 seconds. The flashing short symbol AL appears on the display.
2. Confirm with Enter. The parameter undervoltage $< U$ is flashing.
3. Press the Down key to select the parameter overvoltage $> U$. The parameter $> U$ flashes.
4. Confirm with Enter. A flashing "on" indicates that the response value $> U$ is activated.
5. Confirm the activation of the response value with Enter. The associated value in V appears on a flashing display.
6. Use the Up or Down key to set the appropriate response value. Confirm with Enter. $> U$ flashes.
7. You can exit the menu by:
 - Pressing the Enter key for more than 1.5 seconds to reach the next higher level or
 - selecting the menu item ESC and confirming with Enter to reach the next higher level.



The currently active segments are flashing! In the figures below, the segments where device settings can be carried out are highlighted by an oval.

The menu mode can be reached by pressing the MENU key for more than 1.5 seconds.

5.5.1 Setting: response values for under-, overvoltage and hysteresis

Set the response value at which an alarm is to be issued.

Setting the undervoltage response value < U

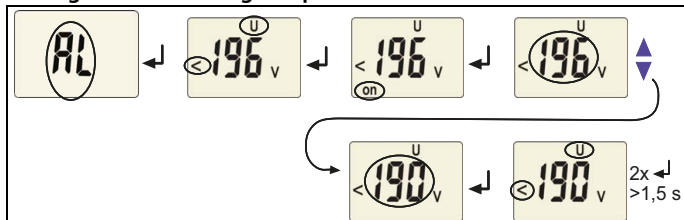

Setting the overvoltage response value > U

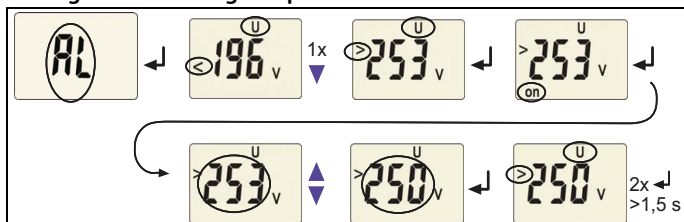

Setting the hysteresis of the voltage response values

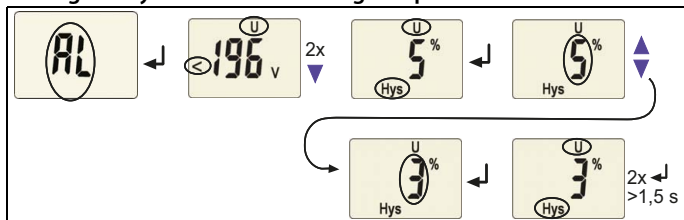

5.5.2 Setting: response values for under-, overfrequency, hysteresis

Setting the underfrequency response value < Hz

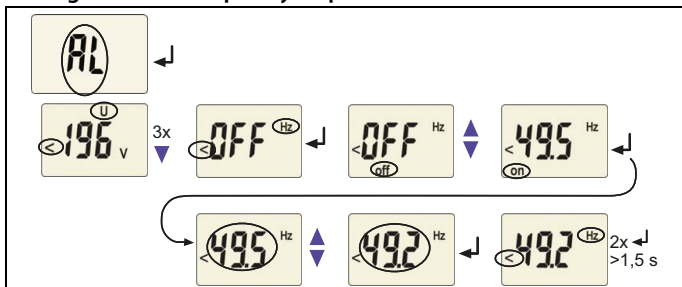

Setting the overfrequency response value > Hz

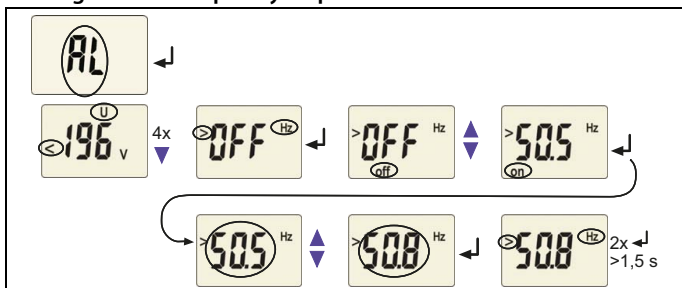

Setting the hysteresis of the frequency response values

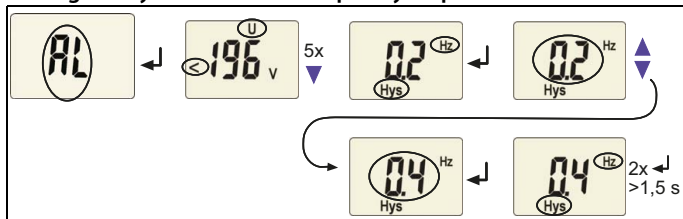

Switch off frequency alarm when the voltage is too low

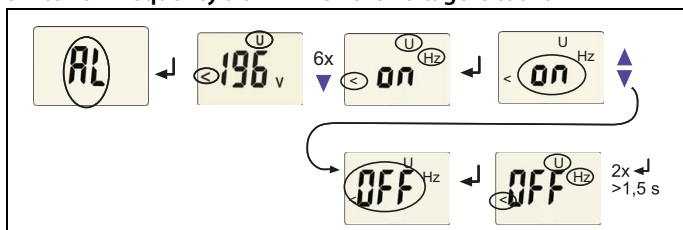

5.5.3 Setting: fault memory and operating principle (alarm relays)

Deactivating the fault memory

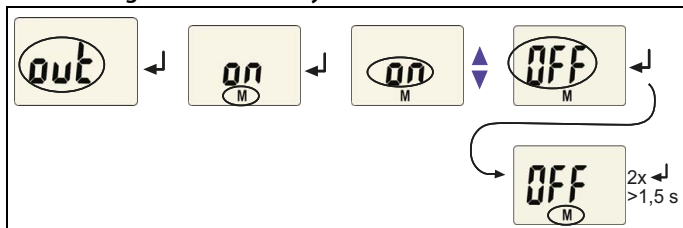

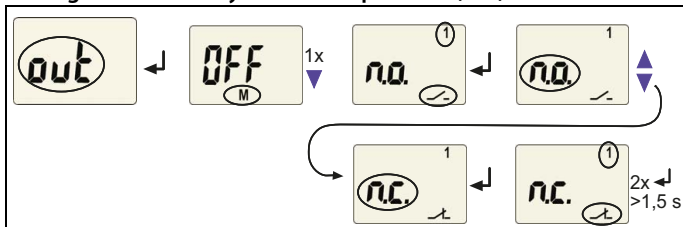
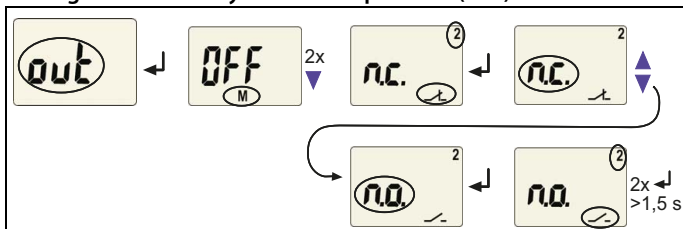
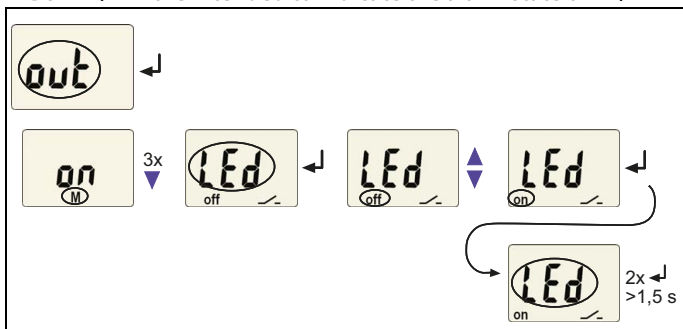
Setting the alarm relay K1 to N/C operation (n.c.)

Setting the alarm relay K2 to N/O operation (n.o.)

LEDs AL1/AL2 are intended to indicate the alarm state of K1/K2

5.5.4 Assigning alarm categories to the alarm relays

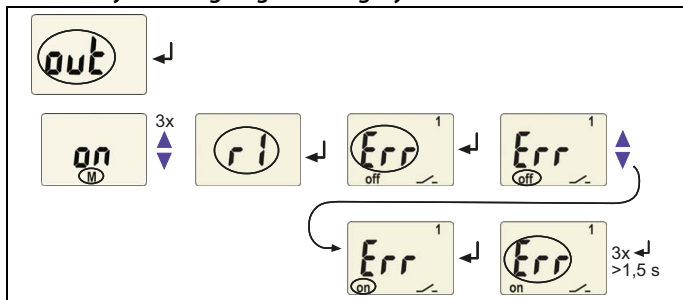
Undervoltage, overvoltage, underfrequency, overfrequency and device-related error messages of the voltage relay can be assigned to the alarm relays K1 (r1, 1) and K2 (r2, 2). K1 is set at the factory to signal an alarm in the event of overvoltage, and K2 is set to signal an alarm in the event of undervoltage. A few assignment examples for alarm relay K1 are illustrated below:

Alarm relay K1: Assigning the category device error



Alarm relay K1: Assigning the category undervoltage

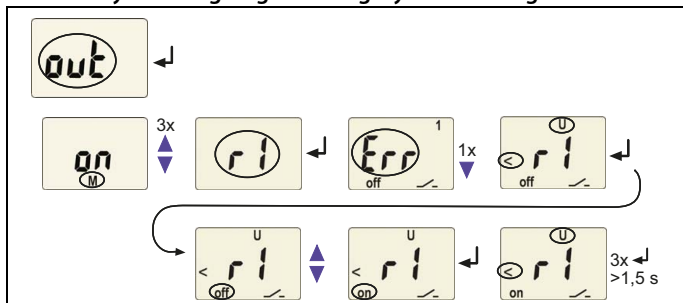

Alarm relay 1: Deactivating the category overvoltage

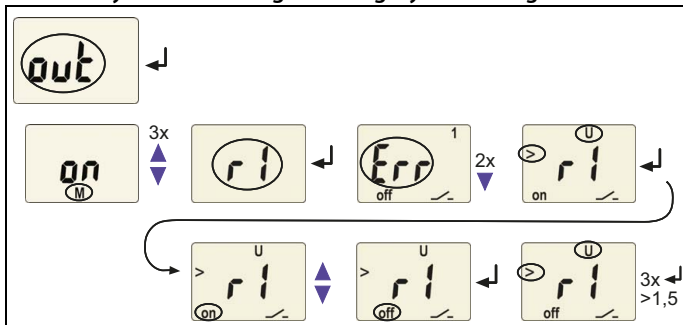

When an alarm relay (K1/K2) has been deactivated via the menu, an alarm will not be signalled by the respective changeover contact! An alarm will only be indicated by the respective alarm LED (AL1/AL2)!
 This only applies to the out menu setting LEd = off!

5.5.5 Setting the time delays

Setting range 0...300 s

- Response delay for K1 t_{on1}
- Response delay for K2 t_{on2}
- Start-up delay during device start t
- Common delay on release for K1 and K2: t_{off}
 (t_{off} is only relevant if fault memory M is deactivated)

The operating steps for the setting of the response delay t_{on1} and the start-up delay t are illustrated by way of example.

Setting the response delay t_{on1}

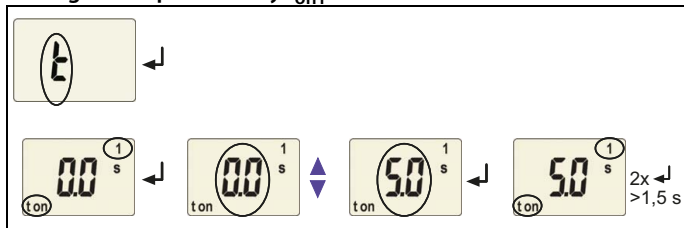

Setting the start-up delay t

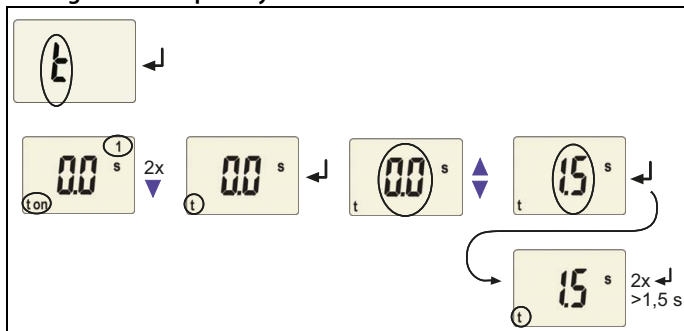

5.5.6 Factory setting and password protection

Use this menu to activate the password protection, to change the password or to deactivate the password protection. In addition, you can reset the device to its factory settings.

a) Activating the password protection

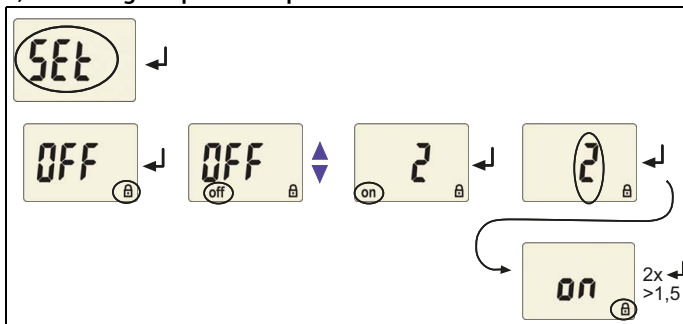

b) Changing the password

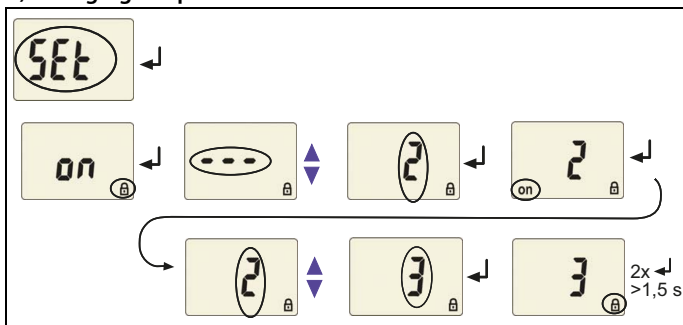

c) Deactivating the password protection

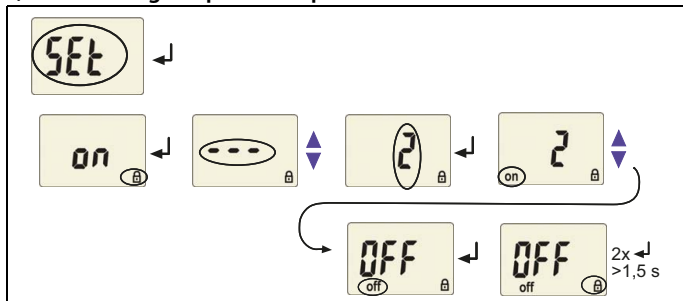

5.5.7 Restoring factory settings

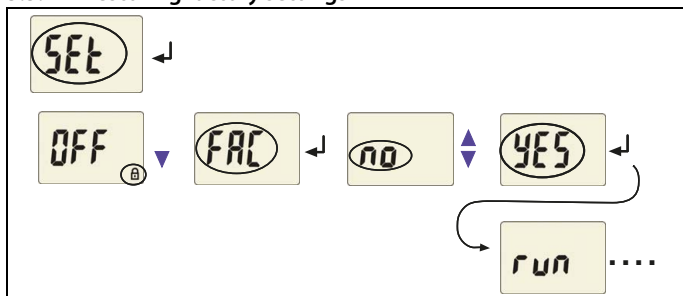

5.5.8 Manual activation of the preset function

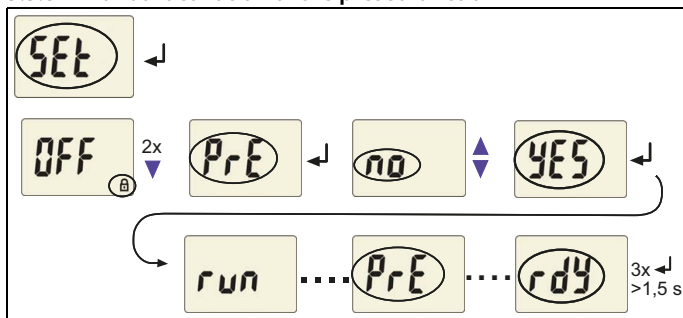

5.5.9 Device information interrogation

This function is used to interrogate the hardware (d...) and software (1.xx) versions. After activating this function, data will be displayed as a scrolling text. Once one pass is completed, you can select individual data sections using the Up/Down keys.

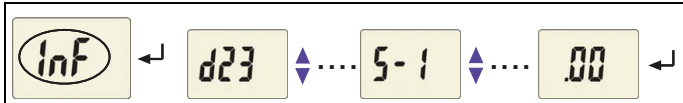

5.5.10 History memory interrogation

The history memory can be selected via the menu HiS. Use the Up and Down keys to view the next display. If Clr is flashing, the history memory can be cleared by pressing the Enter key.



5.6 Preset function/ factory setting

During the first start-up process the following response values are automatically set related to U_n :

Response value: overvoltage ($> U$): $1.1 U_n$

Response value: undervoltage ($< U$): $0.85 U_n$



<i>Hysteresis U</i>	5 %
<i>Underfrequency < Hz</i>	Off
<i>Overfrequency > Hz</i>	Off
<i>Hysteresis frequency (Hys Hz)</i>	0.2 Hz
<i>Frequency alarm <U_ Hz</i>	on
<i>Fault memory M</i>	ON
<i>Operating principle K1 (> U)</i>	N/O operation-(n.o.)
<i>Operating principle K2 (< U)</i>	N/C operation (n.c.)
<i>AL1/AL2 indicate the alarm state of K1/K2 (LEd)</i>	Off
<i>Alarm to K1/K2 (S.AL) when the device is started</i>	Off
<i>Start-up delay</i>	$t = 0 \text{ s}$
<i>Response delay</i>	$t_{on1} = 0 \text{ s},$ $t_{on2} = 0 \text{ s}$
<i>Delay on release</i>	$t_{off} = 0.5 \text{ s}$
<i>Password</i>	0, Off

5.7 Commissioning

Prior to commissioning, check proper connection of the voltage monitor.



After connecting a brand-new VME420 to a standard system of $U_n = 230 \text{ V } 50 \text{ Hz}$, the response values are automatically set by the internal preset function:

Overvoltage = 253 V (230 V + 10 %) (50 Hz + 1 Hz)

Undervoltage = 196 V (230 V - 15 %) (50 Hz - 1 Hz)

Other operating ranges of the preset function are given in the technical data "response values" and in the description of the function.

6. Technical data VME420...

6.1 Data in tabular form

(*) = factory setting

Insulation coordination acc. to IEC 60664-1/IEC 60664-3

Rated insulation voltage	250 V
Rated impulse voltage/overvoltage category.....	4 kV / III
Pollution degree.....	3
Protective separation (reinforced insulation) between:.....	(A1, A2) - (U1/+, U2/-) - (11-12-14) - (21-22-24)
Voltage test acc. to IEC 61010-1	2.21 kV

Supply voltage

VME420-D-1:

Supply voltage U_S	AC 16...72 V / DC 9.6...94 V
Frequency range U_S	15...460 Hz

VME420-D-2:

Supply voltage U_S	AC/DC 70...300 V
Frequency range U_S	15...460 Hz

Power consumption

≤ 4 VA

Measuring circuit

Measuring range (r.m.s.)	AC / DC 0...300 V
Rated frequency f_n	DC, 15...460 Hz
Display, frequency range	10...500 Hz**

Response values

Undervoltage < U (Alarm 2)	AC / DC 6...300 V
Overvoltage > U (Alarm 1)	AC / DC 6...300 V
Resolution of setting U 6.0...49.9 V	0.1 V
Resolution of setting U 50...300 V	1 V
Preset function:	
Undervoltage < U = (0.85 U_n):*	
for $U_n = 230\text{ V} / 120\text{ V} / 60\text{ V} / 24\text{ V}$	196 V / 102 V / 51 V / 20.4 V
Overvoltage > U = (1.1 U_n):*	
for $U_n = 230\text{ V} / 120\text{ V} / 60\text{ V} / 24\text{ V}$	253 V / 132 V / 66 V / 26.4 V

Relative uncertainty voltage at 50/60 Hz	$\pm 1.5\%$, ± 2 digit
Relative uncertainty voltage in the range of 15...460 Hz	$\pm 3\%$, ± 2 digit
Hysteresis U	1...40% (5%)*
Underfrequency < Hz	10...500 Hz**
Overfrequency > Hz	10...500 Hz**
Resolution of setting f 10.0...99.9 Hz.....	0.1 Hz
Resolution of setting f 100...500 Hz	1 Hz
Preset function:	
Underfrequency for $f_n = 16.7\text{ Hz} / 50\text{ Hz} / 60\text{ Hz} / 400\text{ Hz}$	15.7 Hz / 49 Hz / 59 Hz / 399 Hz
Overfrequency for $f_n = 16.7\text{ Hz} / 50\text{ Hz} / 60\text{ Hz} / 400\text{ Hz}$	17.7 Hz / 51 Hz / 61 Hz / 401 Hz
Hysteresis frequency Hys Hz	0.1...2 Hz (0.2 Hz)*
Relative uncertainty frequency in the range of 15...460 Hz	$\pm 0.2\%$, ± 1 digit

Specified time

Start-up delay	0...300 s (0 s)*
Response delay $t_{on1/2}$	0...300 s (0 s)*
Delay on release t_{off}	0...300 s (0.5 s)*
Resolution of setting $t, t_{on1/2}, t_{off}$ (0...10 s).....	0.1 s
Resolution of setting $t, t_{on1/2}, t_{off}$ (10...99 s)	1 s
Resolution of setting $t, t_{on1/2}, t_{off}$ (100...300 s)	10 s
Operating time voltage t_{ae}	DC/AC 16.7 Hz: $\leq 130\text{ ms}$, AC 42...460 Hz: $\leq 70\text{ ms}$
Operating time, frequency t_{ae}	AC 15...460 Hz: $\leq 310\text{ ms}$
Response time t_{an}	$t_{an} = t_{ae} + t_{on1/2}$
Recovery time t_b	$\leq 300\text{ ms}$

Displays, memory

Display	LC display, multi-functional, not illuminated
Display range, measured value	AC/DC 0...300 V
Operating uncertainty at 50/60 Hz	$\pm 1.5\%$, ± 2 digits
Operating uncertainty voltage in the range of 15...460 Hz	$\pm 3\%$, ± 2 digits
Operating uncertainty in the frequency range 15...460 Hz	$\pm 0.2\%$, ± 1 digit
History memory (HiS) for the first alarm value.....	data record measured values
Password	Off / 0...999 (OFF)*
Fault memory (M) alarm relay	on / off / con (on)*

Switching elements

Number of changeover contacts	2 x 1 (K1, K2)
Operating principle	N/C operation / N/O operation
..... K2: Err, < U, > U, < Hz, > Hz, S.AL (undervoltage < U: N/C operation n.c.)*	
..... K1: Err, < U, > U, < Hz, > Hz, S.AL (overvoltage > U: N/O operation n.o.)*	
Electrical endurance.....	10 000 switching operations
Contact data acc. to IEC 60947-5-1:	
Utilisation category	AC 13..... AC 14 DC-12 DC-12..... DC-12
Rated operational voltage	230 V..... 230 V 24 V 110 V..... 220 V
Rated operational current.....	5 A..... 3 A 1 A 0.2 A..... 0.1 A
Minimum contact rating	1 mA at AC/DC ≥ 10 V

Environment/EMC

EMC	IEC 61326
Operating temperature	-25 °C. . . +55 °C
Classification of climatic conditions acc. to IEC 60721:	
Stationary use (IEC 60721-3-3)	3K5 (except condensation and formation of ice)
Transportation (IEC 60721-3-2)	2K11 (except condensation and formation of ice)
Storage (IEC 60721-3-1)	1K22(except condensation and formation of ice)
Classification of mechanical conditions acc. to IEC 60721:	
Stationary use (IEC 60721-3-3)	3M4
Transportation (IEC 60721-3-2)	2M4
Storage (IEC 60721-3-1)	1M12

Option "W" data different from the standard version

Classification of climatic conditions acc. to IEC 60721:	
Stationary use (IEC 60721-3-3)	3K5 (condensation and formation of ice is possible)
Classification of mechanical conditions acc. to IEC 60721:	
Stationary use (IEC 60721-3-3)	3M7

Connection

Connection **screw-type terminals**

Connection properties:

rigid/ flexible 0.2...4/0.2...2.5 mm² / AWG 24...12

Multi-conductor connection (2 conductors with the same cross section):

rigid/ flexible 0.2...1.5 mm² / 0.2...1.5 mm²

Stripping length 8...9 mm

Tightening torque 0.5...0.6 Nm

Connection type **push-wire terminals**

Connection properties:

rigid 0.2...2.5 mm² (AWG 24...14)

Flexible without ferrules 0.75...2.5 mm² (AWG 19...14)

Flexible with ferrules 0.2...1.5 mm² (AWG 24...16)

Stripping length 10 mm

Opening force 50 N

Test opening, diameter 2.1 mm

Other

Operating mode continuous operation

Position any position

Degree of protection DIN EN 60529, internal components IP30

Degree of protection DIN EN 60529, terminals IP20

Enclosure material polycarbonate

Flammability class UL94 V-0

DIN rail mounting acc. to IEC 60715

Screw mounting 2 x M4 with mounting clip

Software version D235 V2.3x

Weight ≤150 g

() * = factory setting

** = The technical data applies to the operating range of the rated frequency (15...460 Hz) only.







6.2 Standards, approvals and certifications



6.3 Ordering information

Device type	Nominal voltage U_n^*	Supply voltage U_s^*	Art. No.
VME420-D-1 (push-wire terminals)	AC/DC 0...300 V 15...460 Hz	DC 9.6 V...94 V / AC 15...460 Hz, 16...72 V	B73010001 B7300001W
VME420-D-1	AC/DC 0...300 V 15...460 Hz	DC 9.6 V...94 V / AC 15...460 Hz, 16...72 V	B93010001 B9300001W
VME420-D-2 (push-wire terminals)	AC/DC 0...300 V 15...460 Hz	DC 70...300 V / AC 15...460 Hz, 70...300 V	B73010002 B7300002W
VME420-D-2	AC/DC 0...300 V 15...460 Hz	DC 70...300 V / AC 15...460 Hz, 70...300 V	B93010002 B93010002W
*Absolute values of the voltage range			
Mounting clip for screw mounting (1 piece per device, accessories)			B98060008

6.4 User settings (overview)

Menu	Parameter	FAC	User setting	Setting range	AL-LED	
AL	U<	ON		V PRESET or	2 *	
	U>	ON		V 6...300V	1 *	
	U Hys	5 %		% 1... 40 %		
	Hz <	OFF		Hz PRESET or	1+2 *	
	Hz >	OFF		Hz 10...500 Hz	1+2 *	
	Hz Hys	0.2 Hz		Hz 0.1... 2.0 Hz		
	<U_Hz	ON		ON / OFF		
out	M	ON		ON / OFF / CON		
	 1	n.o.		n.o. or n.c.		
	 2	n.c.				
	 LEd	OFF			1/2 **	
	r1	 1 Err	OFF			
		r1 U<	OFF			
		r1 U>	ON			
		r1 Hz<	ON			
		r1 Hz>	ON			
		 1 S.AL	OFF		ON / OFF	***
	r2	 2 Err	OFF			
		r2 U<	ON			
		r2 U>	OFF			
		r2 Hz<	ON			
		r2 Hz>	ON			
 2 S.AL		OFF			***	
t	ton 1	0 s		s	0... 300 s	
	ton 2			s		
	t			s		
	toff			s		
Set	Lock	OFF		0...999		

* only when LEd = off, ** only when LEd = on, *** depending on LEd setting

INDEX

A

Adjustable parameters, list 25, 26, 27

Automatic self test 16

C

currently measured values

- nominal voltage 27

- rated frequency 27

D

Delay on release toff 17

Deleting the fault alarms 24

Device features 13

Display elements in use 23

Display in menu mode 28

Display in standard mode 27

E

Enter key 25

Example of parameter setting 30

F

factory 41

factory setting 18, 41

Fast commissioning for $U_n = 230\text{ V}$ 13

Fault memory in the operating mode on, off
or con 13, 16

Function 15

Functional fault 16

H

How to use this manual 5

I

Indication of the alarm state of K1/K2 18

Intended use 12

K

K1: assignment alarm category 26

K2: assignment alarm category 26

L

LED Alarm 1 lights 24

LED Alarm 2 lights 24

M

Manual self test 16

Menu

- AL (response values) 25

- HiS (history memory for the first
alarm value) 27

- InF (hard and software version) 27

- out (output control) 26

- Set (device control) 27

- t (timing check) 26

Menu item Led 18

Menu structure 25

Mounting clip for screw mounting 47

O

Operating elements, function 24

Operation and setting 23

Ordering information 47

P

Parameter query and setting

- 28

Parameter setting

- Activating or deactivating the password protection 38

- Assigning alarm categories to the alarm relays 35

- Deactivating the fault memory 33

- Response value setting 30

- Setting the operating principle of the alarm relays 33

- Setting the time delays 37

Password protection 17

Preset function 15

R

Reset button 24

Response delay ton 17, 37

Response value setting

- Hysteresis frequency 33

- Hysteresis U 31

- Overfrequency (> Hz) 32

- Overvoltage (> U) 31

- Underfrequency (< Hz) 32

- Undervoltage (< U) 31

S

Service 6

Simulated alarm 18

Starting a device using a simulated alarm

S.AL 18

Starting the menu mode 25

Start-up delay t 17, 37

Support 6

T

Technical data 43

Test button 24

Time delays 15, 17

Training courses 8

V

Voltage timing diagram 47

W

Wiring diagram 22

Work activities on electrical installations 11
workshops 8

optec

energie ist messbar

Optec AG | Guyer-Zeller-Strasse 14 | CH-8620 Wetzikon ZH

Telefon: +41 44 933 07 70 | Telefax: +41 44 933 07 77

E-Mail: info@optec.ch | Internet: www.optec.ch



Bender GmbH & Co. KG

P.O. Box 1161 • 35301 Gruenberg • Germany

Londorfer Strasse 65 • 35305 Gruenberg • Germany

Tel.: +49 6401 807-0 • Fax: +49 6401 807-259

E-Mail: info@bender.de • www.bender.de

Photos: Bender archives



BENDER Group