

www.janitza.com

Janitza electronics GmbH
Vor dem Polstück 1
D-35633 Lahnau
Support tel. 0049 6441 9642-22
Fax 0049 6441 9642-30
E-mail: info@janitza.com
Internet: <http://www.janitza.com>

Datalogger ProData 2

Operating instructions and technical data

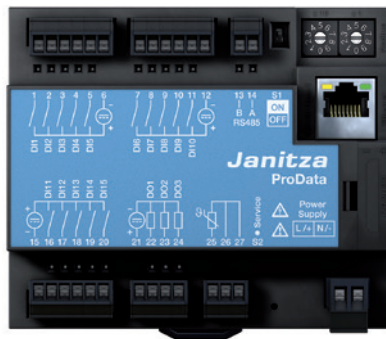

Janitza[®]

Table of contents

General	3	Pulse counters	31
Inspection on receipt	6	Events	33
Scope of delivery of ProData 2	7	Clock	34
Available accessories	7	Timer	34
Product description	8	Recordings	35
Proper use	8	Data memory	35
ProData 2 features	9	Rate conversion	36
GridVis network analysis software	10	Temperature measurement input	38
Connection variants	12	Ethernet	39
Installation	14	Modbus gateway	40
Position of installation	14	Service and maintenance	42
Installation	14	Service	42
Supply voltage	14	Device calibration	42
RS485 interface	16	Calibration	42
Ethernet interface	19	Battery	43
Digital outputs	20	Replacing the battery	44
Digital inputs	22	Firmware update	45
Temperature measurement input	25	Procedure in the event of faults	46
Device address (RS485)	26	Technical data	48
DIP switch S1	27	Dimension diagrams	52
Service button S2	27	Declaration of conformity	54
LED device status	27	Connection example	56
Configuration and commissioning	28		
Connecting the supply voltage	28		
RS485 interface	28		
Digital inputs	30		

General

Copyright

This operating manual is subject to the legal requirements for copyright protection and may not be, either in whole or in part, photocopied, reprinted, or reproduced by mechanical or electronic means, or in any other manner be duplicated or redistributed without the legally binding, written agreement of

Janitza electronics GmbH, Vor dem Polstück 1,
D 35633 Lahnau, Germany.

Trademarks

All trademarks and their resulting rights belong to the respective holders of these rights.

Disclaimer

Janitza electronics GmbH takes no responsibility for errors or defects within this operating manual and takes no responsibility for keeping the contents of this operating manual up to date.

Comments on the operating manual

We welcome your comments. In the event that anything in this operating manual seems unclear, please let us know and send us an EMAIL at: info@janitza.de

Meaning of the symbols

The following pictograms are used in this manual:



Dangerous voltage!

Danger to life or risk of serious injury. Disconnect the system and device from the power supply before beginning work.



Caution!

Please follow the documentation. This symbol warns of possible dangers that can arise during installation, commissioning and use.



Note!

Instructions for use

Please read the operating manual included in the delivery as well as all other publications that must be referred to for working with this product (in particular for the installation, operation or maintenance).

Follow all safety regulations and warning information. If you do not follow the information, it can result in bodily injury and/or damage to the product.

Any unauthorised changes or use of this device, which go beyond the mechanical, electrical or otherwise stated operating limitations, can result in bodily injury or/and damage to the product.

Any such unauthorised changes constitute "misuse" and/or "negligence" in terms of the warranty for the product and, therefore, invalidate the warranty for covering any potential damage that result.

This device is to be operated and maintained exclusively by specialised personnel. Specialised personnel are persons who, based on their respective training and experience, are qualified to recognise risks and prevent potential dangers that can be caused by the operation or maintenance of the device.

Additional legal and safety regulations required for the respective application are to be followed when using the device.



If the device is not operated according to the operating manual, protection is no longer ensured and hazards can be presented by the device.



Conductors made from single wires must be fitted with wire-end ferrules.



Only pluggable screw terminals with the same number of poles and the same type of construction are permitted to be connected together.

Concerning these operating instructions

These operating instructions are part of the product.

- Read the operating instructions before using the device.
- Keep the operating instructions throughout the entire service life of the product and have them readily available for reference.
- Pass the operating instructions on to each subsequent owner or user of the product.



All screw-type terminals included in the scope of delivery are attached to the device.

Inspection on receipt

The prerequisites of faultless, safe operation of this device are proper transport and proper storage, set-up and assembly, as well as careful operation and maintenance. If it can be assumed that risk-free operation is no longer possible, the unit must be immediately put out of operation and secured against being put back into operation again.

Packing and unpacking must be carried out with customary care without the use of force and only using suitable tools. The devices should be visually checked for flawless mechanical condition.

It can be assumed that risk-free operation is no longer possible if the device, for example,

- has visible damage,
- no longer works despite being connected to the mains power supply,
- has been exposed to prolonged adverse conditions (e.g. storage outside the permissible climate limits without being adapted to the room climate, condensation, etc.) or rough handling during transportation (e.g. falling from a height, even if there is no visible external damage, etc.)
- Please check the delivered items for completeness before you start installing the device.

Scope of delivery of ProData 2

Number	Part no.	Description
1	52.24.001	ProData 2
1	33.03.168	Operating instructions
1	51.00.116	CD with following content - GridVis programming software - GridVis functional description
1	10.01.855	Screw-type terminal, pluggable, 2-pin (supply voltage)
3	10.01.873	Screw-type terminal, pluggable, 6-pin (digital/pulse inputs)
1	10.01.861	Screw-type terminal, pluggable, 4-pin (digital outputs)
1	10.01.857	Screw-type terminal, pluggable, 2-pin (RS 485)
1	10.01.859	Screw-type terminal, pluggable, 3-pin (temperature input)
1	08.01.505	Patch cable 2 m, coiled, grey (ProData/switch connection)

Available accessories

Part no.	Description
21.01.058	Battery 3 V, TYPE CR2032 (approved in acc. with UL1642)
52.24.111	S0 module for a group of S0 inputs, equipped with 1.3 kOhm resistors

Product description

Proper use

The ProData 2 is designed for fixed installation (mounting rail assembly) in low voltage switchgear and is suitable for recording and saving counter values and process data.

The data can be used to evaluate the energy consumption and operating hours, or to monitor switching states and faults in buildings, production facilities, etc.

The auxiliary voltage, the digital inputs, the interfaces, etc. are connected via intrinsically safe plug-in terminals and via an Ethernet plug.

ProData 2 features

- 15 digital/pulse inputs
- 3 digital outputs, switchable via Modbus, weekly timer, boundary value and temperature monitoring
- Temperature measurement input
- Ethernet interface (Modbus TCP)
- RS485 (Modbus RTU, slave, up to 115 kbps)
- 32 MB flash memory (29 MB usable for recordings)
- Assembly on mounting rails (35 mm)
- Connection via pluggable screw terminals
- Clock and battery function
- Weekly timer
- Threshold value monitoring
- Modbus gateway functionality^{*1}
- Working temperature range -40 °C .. +55 °C
- Saving minimum and maximum values (with time stamp)
- Configurable records, can be read out via RS485 and Ethernet

^{*1} Use as a Modbus RTU slave is not possible in this mode. The ProData 2 can only forward queries to a Modbus slave device; it cannot query Modbus slave devices independently.

Parameterisation

The parameterisation of all device functions takes place via the RS485 serial interface or via Ethernet and with the GridVis programming software.

The Modbus protocol can be used to change and retrieve data using the Modbus address list (available on the Internet or the enclosed CD).

GridVis network analysis software

The ProData 2 can be programmed and read out using the GridVis network analysis software included in the scope of delivery. For this, a PC must be connected to the ProData 2 via a serial interface (RS485) or via Ethernet (see the connection variants).

GridVis features

- Programming the ProData 2
- Graphical representation of measured values



Additional components that are not included in the scope of deliverables will be required for parameterisation via the RS485 interface.

Connection variants

Connection of a ProData 2 to a PC via an interface converter:

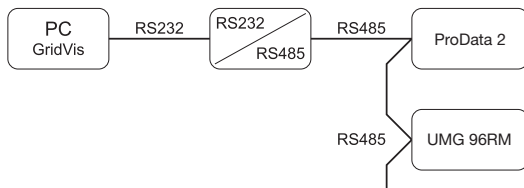

Direct connection of a ProData 2 to a PC via Ethernet.



Connection of a ProData 2 via a UMG 604 as a gateway.

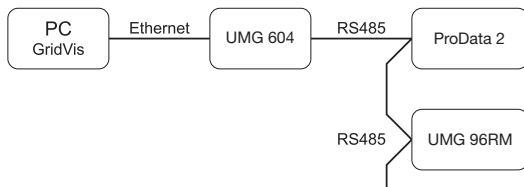

Connection of a ProData 2 to a PC via Ethernet.

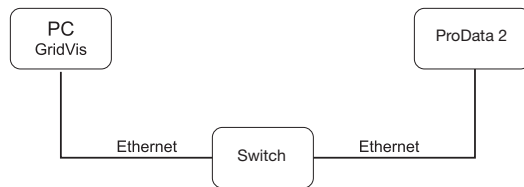

Connection of a ProData 2 with gateway function to a PC via Ethernet.

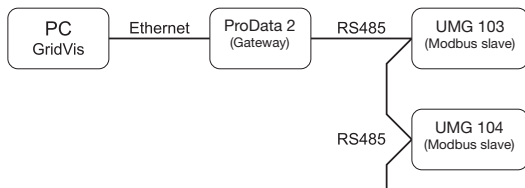

In this installation, the ProData 2 can forward queries (e.g. from the GridVis software) to a Modbus slave device. However, it CANNOT query Modbus slave devices independently!

RS485 mode: Gateway; address 3=1

Connecting a ProData 2 as a Modbus slave device.

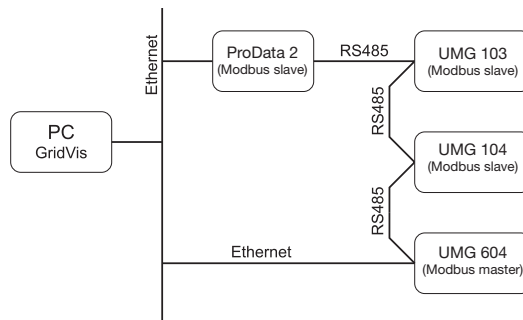

The ProData 2 is configured as a Modbus slave. Communication to the ProData 2 can take place directly via Ethernet or via the Modbus master.

The ProData 2 cannot forward any Ethernet queries to a Modbus slave device!

RS485 mode: Slave; address 3=0

Installation

Position of installation

The ProData 2 is designed for fixed installation in low voltage switching devices. It is assembled on a 35 mm mounting rail in accordance with DIN EN 60715. Can be installed in any mounting position.

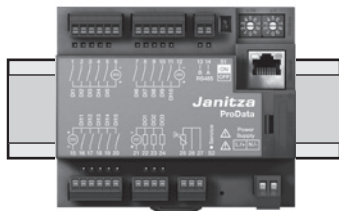

Installation

Supply voltage

The ProData 2 requires a supply voltage to operate. The supply voltage is connected to the front side of the device via a 2-pin plug-in terminal.

Before connecting the supply voltage, make sure that the voltage and frequency correspond to the details on the ratings plate.

The supply voltage must be connected through a UL/IEC approved fuse (6 A, type CC) or a circuit breaker (6 A, C.Char).



- If installed in a building, a disconnect or circuit breaker must be provided for the supply voltage.
- The disconnect must be installed near the device and easily accessible to the user.
- The switch must be marked as the circuit breaker for this device.
- Voltages which are over the permitted voltage range can destroy the device.

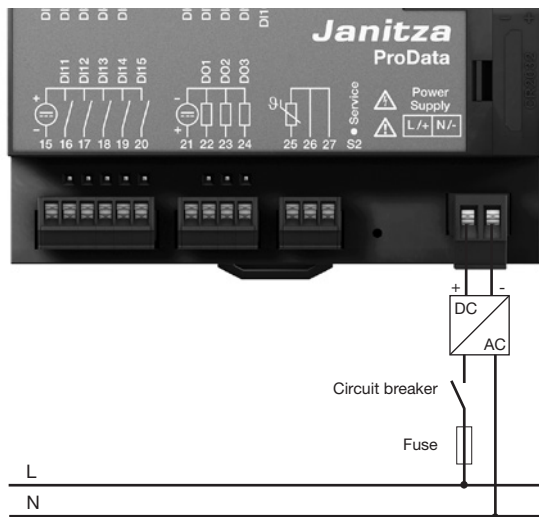

Fig. Connection example of the supply voltage to a ProData 2 via an external mains supply.

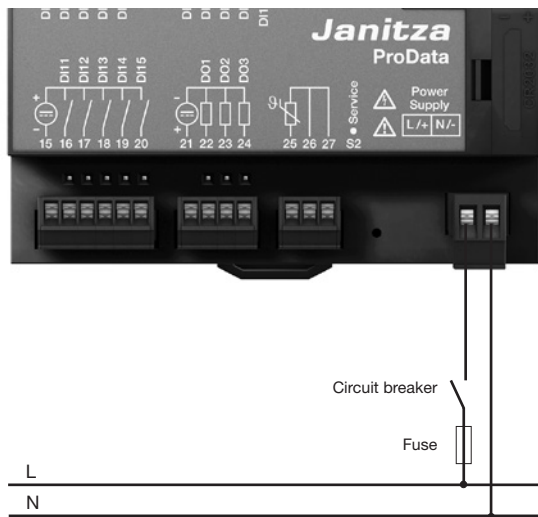

Fig. Connection example of the supply voltage to a ProData 2.

RS485 interface

In the ProData 2, the RS485 interface is designed as a 2-pin plug contact, which communicates via the Modbus RTU protocol (also see Parameter programming).

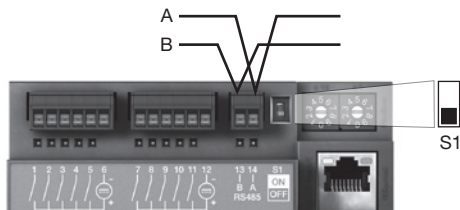

Fig.: Placement in the middle of the segment; termination via DIP switch S1 deactivated (OFF)

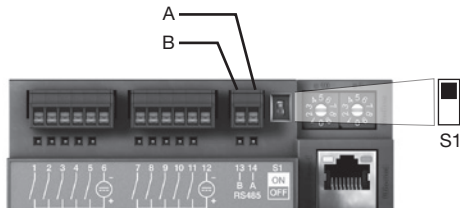

Fig.: Placement at the end of the segment; termination via DIP switch S1 activated (ON)

Termination resistors

The cable is terminated with resistors (120 Ohm, 1/4 W) at the beginning and at the end of a segment.

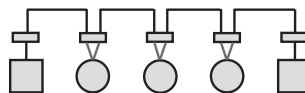

Termination within the device is possible via the S1 DIP switch of the ProData 2.

Correct

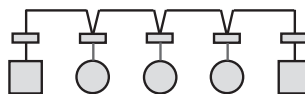

Incorrect



-  Terminal strip in the cabinet.
-  Device with RS485 interface (without terminating resistor).
-  Device with RS485 interface (with terminating resistor on the device).

Screening

Twisted screened cable should be used for connections via the RS485 interface.

- Earth the screens of all cables that lead to the cabinet upon entering the cabinet.
- Connect the screens over a generous area and in a manner that will conduct well to a low-noise earth.
- Gather the cables mechanically above the earthing clamp in order to avoid damage due to cable movements.
- Use suitable cable glands to feed the cables into the cabinet - e.g. armoured conduit couplings.

Cable type

The cable used must be suitable for an environmental temperature of at least 80 °C.

Recommended cable types:

Unitronic Li2YCY(TP) 2x2x0.22 (from Lapp Kabel)

Unitronic BUS L2/FIP 1x2x0.64 (from Lapp Kabel)

Maximum cable length

1200 m at a baud rate of 38.4 kbits.

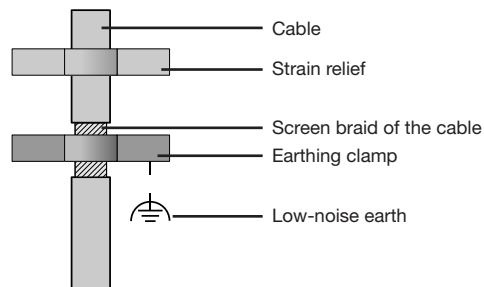

Fig. Screening procedure at cabinet entry.

Bus structure

- All devices are connected in a bus structure (line) and each device has its own address within the bus (see also Parameter programming).
- Up to 32 subscribers can be connected together in a single segment.
- The cable is terminated with resistors (bus termination 120Ohm, 1/4W) at the beginning and at the end of a segment.
- With more than 32 subscribers, repeaters (amplifiers) must be used to connect the individual segments.
- Devices for which the bus connection is switched on must be under current.
- It is recommended that the master be placed at the end of a segment.
- If the master is replaced with a bus connection, the bus must be switched off.
- Replacing a slave with a bus connection that is either switched on or de-energised can destabilise the bus.
- Devices that are not connected to the bus can be replaced without destabilising the bus.

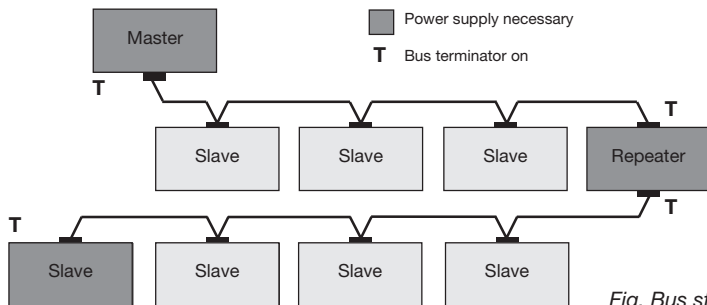
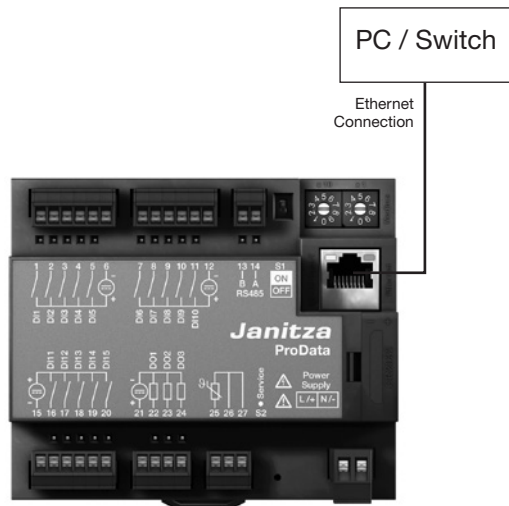

Fig. Bus structure

Ethernet interface

The Ethernet network settings should be specified by the network administrator and set accordingly on the ProData 2 using the GridVis software.

If the network settings are not known, the ProData 2 may not be integrated into the network via the patch cable.



LEDs of the Ethernet interface

LED	Function
Yellow	Illuminates when a connection (LINK) is present.
Green	Illuminates sporadically when a network activity occurs.



Caution!

Connection of the ProData 2 to the Ethernet may only be carried out after discussion with the network administrator.



Caution!

The ProData 2 is factory-set to the fixed IP address **10.10.10.200** (subnet mask 255.0.0.0). The allocation of a dynamic IP address is disabled.

The settings can be changed via a suitable Ethernet connection using the GridVis software.

Digital outputs

The ProData 2 features three digital outputs that have a joint reference. The status of each of the outputs is shown by the corresponding LED. The corresponding LED illuminates red when the output is set to active, regardless of whether there is a continuing connection to this interface.

Digital output 1 can also be configured to monitor the temperature. This can be switched via the temperature measurement input and using a comparator.

- The digital outputs can be controlled via Modbus and the weekly timer.
- An external auxiliary voltage is required.
- The digital outputs can switch AC and DC loads.
- The digital outputs are **not** short-circuit proof.
- Connected cables that are longer than 30 m must be shielded when laid.

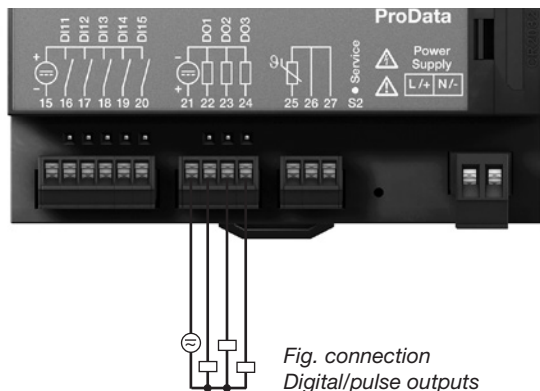

*Fig. connection
Digital/pulse outputs*

DC connection example

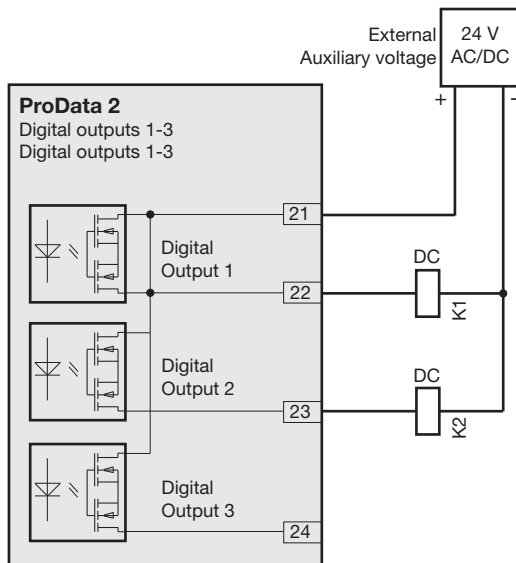

Fig. Example of two relays connected to the digital outputs

**Caution!**

Digital outputs are not short-circuit proof.



Functions for the digital outputs can be adjusted clearly in the GridVis software provided in the scope of delivery. A connection between the ProData 2 and the PC via an interface is required to use the GridVis software.



When using the digital outputs as pulse outputs, the auxiliary voltage (DC) must have a maximum residual ripple of 5%.

Digital inputs

The ProData 2 features 15 digital inputs, which are subdivided into three groups of 5 inputs, each with a joint earth.

The status of each of the inputs is shown by the corresponding LED. The corresponding LED illuminates green if there is a signal on this interface.

An input signal is recognised (signal "1") if a voltage of at least 18 V is applied (typically 4 mA at 24 V). If the voltage is lower than 5 V DC, no input signal exists (signal "0").

Wiring longer than 30 m must be screened.

Correct polarity of the supply voltage (20 ... 30 V DC) must be ensured!

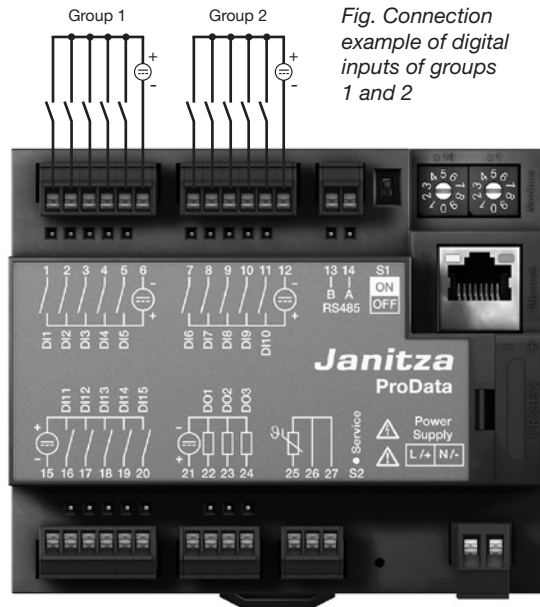

Caution!

Correct polarity of the supply voltage for the digital inputs must be ensured.

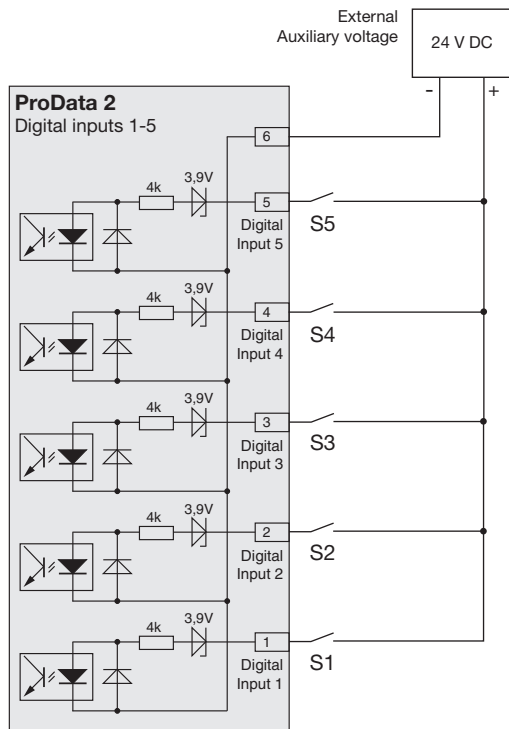

Fig. Example of the connection of external switch contacts S1 to S5 to digital inputs 1 to 5.

S0 pulse input

You can connect an S0 pulse transducer per DIN EN62053-31 to any digital input.

This requires an auxiliary voltage with an output voltage in the range 20 .. 27 V DC and a resistor of 1.3 kOhm/1 W.

S0 plug-in module

(optional, article number 52.24.111)

- Enables simple and fast connection of S0 pulse transducers.
- Module for a group of 5 inputs with integrated resistors.

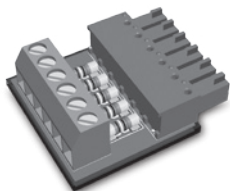
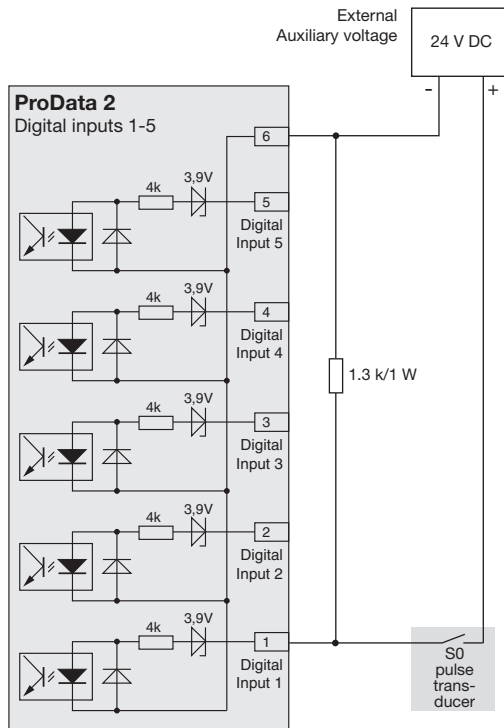

Fig.: S0 plug-in module to connect S0 pulse transducers



Temperature measurement input

Temperature sensors with a resistance region of between 60 Ohm and 2.6 kOhm can be connected to the temperature measurement input. Do not exceed the total resistance load (sensor + cable) of 4 kOhm.

The temperature measurement value is determined once per second. The sensor type and the desired temperature offset can be set using the GridVis software or a Modbus.

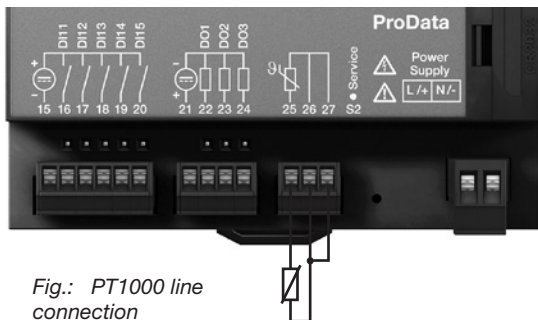
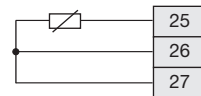
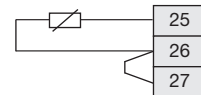

Fig.: PT1000 line connection

Example:
3-line connection PT100



Example:
2-line connection PT1000



Example:
2-line connection KTY83

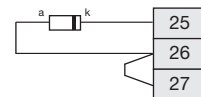

When connecting the KTY83/84 sensor, correct polarity must be ensured. The negative connection (indicated with a black ring) must be connected to terminal 25.

Device address (RS485)

If multiple devices are connected to each other via the RS485 interface, a master device can only identify the devices by their device address. Within a network, each device must have its own device address.

The device address can be configured via the rotary switch that is available on the ProData 2. In this way addresses can be set in the range of 1 to 99.

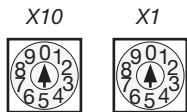

The device address 0 0 is reserved and may not be assigned for operation with Modbus communication.

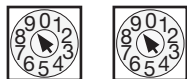

The device address 99 is reached by setting the rotary switch X10 to 9 and X1 to 9. A device address with a higher value cannot be set for the ProData 2.

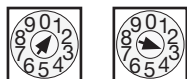

Example: Setting the device address to 13.



Factory setting:
Device address 1.

Setting options for the device address via the rotary switch

DIP switch S1
(device termination)

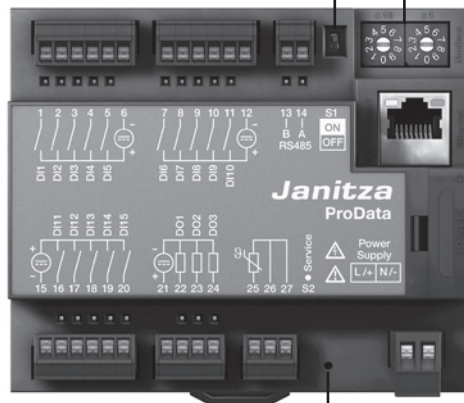

Service button S2

DIP switch S1

If the ProData 2 is integrated into a bus via the RS485 interface, a termination resistor has to be set (see the RS485 interface, termination resistors chapter) depending on the placement of the ProData within the segment.

Termination within the device is possible via the S1 DIP switch of the ProData 2.

Service button S2

The service button is only to be used by instructed service employees and must not be pressed by those who are not acquainted with it.

LED device status

The status LEDs below the RS485 interface show different states of the device. During the start process, the red and the green LEDs illuminate at the same time. Once the start process is complete (approximately 15 seconds), the red LED illuminates; the green LED indicates flawless operation of the device.

LED	Function
Red/Green	Shows the initialisation process during the start phase (approx. 15 seconds)
Green	Device is operational
Red	Device error
Red/Green	If the start process is complete and both LEDs are still illuminated, the initialisation process was interrupted. Perform a device update (firmware) via the software.

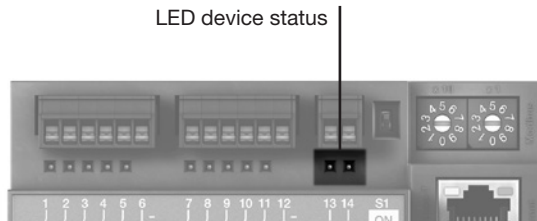

Configuration and commissioning

Connecting the supply voltage

The supply voltage must be connected to configure and commission the ProData 2.

The supply voltage level for the ProData 2 is specified on the rating plate.

RS485 interface

The following parameters must be set to operate the RS485 interface:

- Device termination (termination resistor)
- Device address (see the device address chapter)
- Baud rate
- Stop bits

The factory settings and the setting area for the baud rate are specified in the parameter list.

Device termination (termination resistor)

For fault-free operation of the devices within a bus structure, termination resistors must be set at the start and the end of a segment. If the ProData 2 is at the start or the end of a segment, a termination can be switched via the DIP switch S1.

S1	
<input type="checkbox"/> ON	ON: Device termination active (120 Ohm)
<input type="checkbox"/> OFF	OFF: Device termination inactive

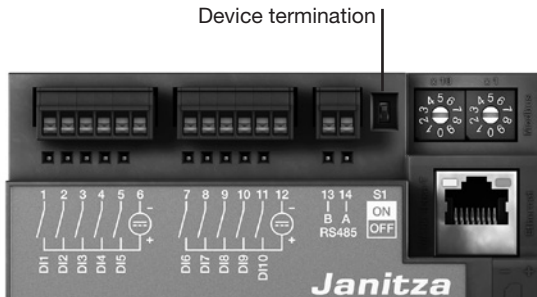

Baud rate

A common baud rate can be adjusted for the RS485 interface. The baud rate must be selected consistently in the grid and set via address 002.

Address 004 can be used to set the number of stop bits where 0=1 bit (factory setting) and 1=2 bits. Data bits (8) and parity (none) are fixed default values.

Setting	Baud rate
0	9.6kbps
1	19.2kbps
2	38.4kbps
3	57.6kbps
4	115.2kbps (factory setting)

Digital inputs

The ProData 2 features 15 digital inputs, which are subdivided into three groups of 5 inputs:

- The status of each of the inputs is shown by the corresponding LED. The corresponding LED illuminates green if there is a signal on this interface.
- The GridVis software can be used to assign a name, unit and description to each digital input.
- The states of the digital inputs are each located on their own Modbus address.
- The last 16 switches (events) are logged with a time stamp for each digital input.
- Digital inputs 1-10 can be configured as functional inputs. Operating these inputs as pulse counters is not possible in this configuration.
- A tariff selection can be assigned to each digital input where only the highest activated tariff runs.

Functional attributes

Specific functions can be assigned to digital inputs 1 - 10. In this function mode, operating these inputs as pulse counters is not possible.

Digital input 1 to 8:

Configuration as tariff converter

Digital input 9:

Synchronisation of the internal clock; choosing between minute or hour synchronisation is possible. However, synchronisation is also possible via a Modbus address.

Digital input 10:

Reset for the synchronisation values (see notes). You also have the option of resetting the mean values via a Modbus address.

Pulse counters

All digital inputs can be operated with a frequency of 25 Hz. Here, the pulse duration and the pulse interval must be greater than 20 ms. The typical pulse duration for S0 pulses is 30 ms.



The maximum number of pulses per hour is based on the minimum pulse duration and the minimum pulse interval:

Pulse length	Pulse interval	Max. pulse/h
20 ms	20 ms	90 000 pulse/h
30 ms	30 ms	60 000 pulse/h
50 ms	50 ms	36 000 pulse/h
100 ms	100 ms	18 000 pulse/h
500 ms	500 ms	3600 pulse/h
1 s	1 s	1800 pulse/h
10 s	10 s	180 pulse/h

Examples of the maximum possible number of pulses per hour.

The pulse counters can be configured with a simultaneous measurement value or power calculation. The pulses are counted as 64-bit numbers and overflow after approximately 1.17×10^{10} years of continuous operation (25 Hz).

Pulse value:

A pulse value can be assigned to each digital input. Use the impulse value to specify the measurement value or power value (e.g. energy) to which a pulse should correspond.

Measurement value calculation:

$$\text{Measurement value} = \text{pulse} \times \text{pulse value}$$

Power value calculation:

$$\text{Power value} = \frac{\text{pulse} \times \text{pulse value}}{\text{Time [sec]}}$$

S0 power values

Since the pulse interval may be very large, continual calculation of the measurement or power values is not possible. For this reason, only the mean values are calculated. For measurement value calculation, the mean values are calculated from the number of pulses per period multiplied by the pulse value. For power value calculation, this value must be divided by the amount of time that can be set.



The calculation result for the S0-power value is not until the end of the cycle available.

The period is assigned to the digital input and can be set in a region of 1 to 60 minutes. After the period ends, the value can be called via the Modbus.

For each digital input, an external synchronisation can be triggered; in this case, a synchronisation pulse completes one period and starts a new period. A fixed capture period of 30 seconds is preset for external synchronisation. If no synchronisation pulse exists after the period expires, a maximum of 30 seconds is waited and the software then carries out the synchronisation. All further periods are synchronised by the software.

A period of 15 min is the factory setting.

Events

Events are status changes of the relevant digital inputs that are logged in a ring buffer.

Status changes (events):

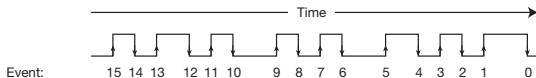

The ring buffer saves the last 16 events for each digital input and specifies the time stamp and the current status. Within the ring buffer, the event field with the index 0 always describes the current status of the relevant digital input.

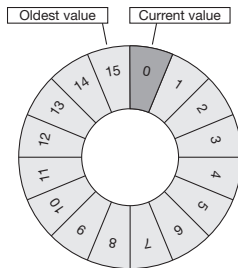

Fig.: Ring buffer for 16 field elements

Clock

The internal device clock is recorded in UTC (Universal Time Coordinated) format with a resolution of 1 second and converted into the local time via a possible configuration of the time zone and the switch between daylight saving time and standard time.

The time can be read and set via a Modbus address. The GridVis software can be used as a user-friendly way to set the clock.

A minute or hour synchronisation of the time takes place via digital input 9.

Example:

Current device time	Time after minute pulse
15:05:51	15:06:00
15:05:11	15:05:00
Current device time	Time after hour pulse
15:05:11	15:00:00

When synchronising the time via Ethernet (NTP), the external clock is only set and is read during a restart. The NTP service can receive broadcasts (passive) or send queries to an NTP server (active). In active mode, an NTP server with the IP address must be set. A name resolution is not possible.

Timer

In the ProData 2, 64 independent weekly timers can be set; here, the resolution is 1 minute. The weekly timer defines an active period within a day; the active day must be released within a week.

Example of an active period:

From 9:25 to 11:45 am Sunday, Monday and Friday

The weekly timers can be configured as tariff converters (1..8), setting digital outputs 1-3, but also as "inoperable". The status can always be queried via the Modbus. The states of the timer are linked via an OR operator to the digital output.

The weekly timer must be set using the GridVis software.

Recordings

Recordings in the data flash (for GridVis software):

- Up to 8 recordings with up to 29 values can be stored in the ProData 2.
- The smallest time basis for recordings is 1 minute and the largest time basis is 60 min.
- Recordings and the names of the power values can be adjusted and extended via the GridVis software.

Data memory

The size of the ProData 2's flash memory is 32 MB; 24 MB is available for recordings and 5 MB is available for the cyclical drawings of the work values.

Recording all 15 channels at a recording interval of 15 minutes results in a recording depth of approximately 1024 days.

The memory is read or deleted via a Modbus or via the GridVis software.

Rate conversion

A tariff selection of 1 to 8 can be assigned to each digital input; the tariffs can be activated via digital inputs 1-8, via a Modbus and via the timer. Each input can be reset individually via the GridVis software.

The tariff conversion via Modbus takes place via addresses 1940 (for digital input 1) to 1954 (digital input 16). The relevant tariff is to be selected by setting or deleting bits 0 to 7. Only the highest-value tariff is evaluated.

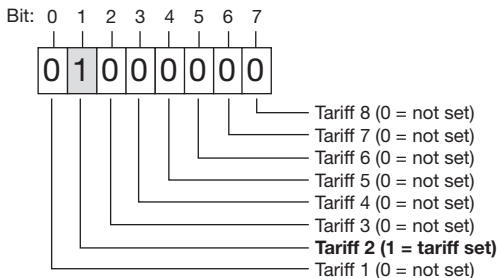

Example of tariff 2 set: If the value is set to address 1940, the tariff conversion for digital input 1 applies.

Bit-by-bit representation of the tariff conversion

	Tariff	T1	T2	T3	T4	T5	T6	T7	T8
	Bit	0	1	2	3	4	5	6	7
Input	Address								
1	1940	0	1	0	0	0	0	0	0
2	1941	0	0	0	0	0	0	0	0
...	...								
15	1954	0	0	1	0	0	0	0	0

Example: For digital input 1, tariff 2 is set, for input 15, tariff 3 is set.

In addition to the tariff conversion, the individual tariffs are to be activated via Modbus addresses 1700 (tariff 1) to 1707 (tariff 8).

Address	Tariff	
1700	1	0 = tariff deactivated, 1 = tariff activated
1701	2	0 = tariff deactivated, 1 = tariff activated
1702	3	0 = tariff deactivated, 1 = tariff activated
...
1707	8	0 = tariff deactivated, 1 = tariff activated

Temperature measurement input

The temperature measurement value is determined once per second. The sensor type and the desired temperature offset can be set using the GridVis software or a Modbus.

Threshold value monitoring of the temperature measurement input is possible using a comparator. The results of the comparator can be combined with the OR operator.

The combination result of the comparator group can be assigned to digital output 1.

Sensor types:

- PT100 / PT1000
- KTY83 / KTY84



Threshold value monitoring can be adjusted clearly in the GridVis software provided in the scope of delivery. A connection between the ProData 2 and the PC via an interface is required to use the GridVis software.

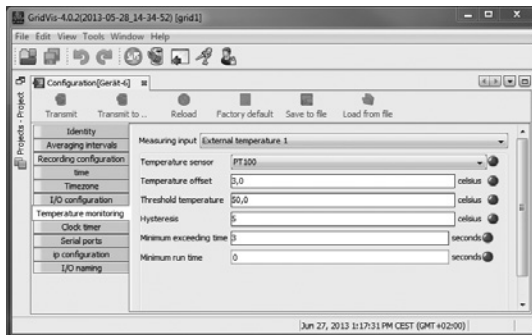

Fig.: GridVis software, configuration menu

Ethernet

Within an Ethernet, each device has a unique TCP/IP address that can be assigned manually or from a DHCP server.

Fixed IP address:

In simple networks without a DHCP server, the network address of the ProData 2 must be set via a Modbus or via the GridVis software.

BootP:

BootP allows for fully-automatic integration of the ProData 2 into an existing network. However, BootP is an older protocol and does not provide the scope of functions provided by DHCP.

DHCP mode:

DHCP allows for fully-automatic integration of a ProData 2 into an existing network with a DHCP server without additional configuration. When started, the ProData 2 automatically obtains the IP address, the network mask and the gateway from the DHCP server.

Factory default settings:	Fixed IP address
IP address	10.10.10.200
Subnet mask	255.0.0.0
DHCP	deactivated



Caution!

Connection of the ProData 2 to the Ethernet may only be carried out after discussion with the network administrator.



Caution!

The device is factory-set to the fixed IP address **10.10.10.200** (subnet mask 255.0.0.0). The allocation of a dynamic IP address is disabled.

The settings can be changed via a suitable Ethernet connection using the GridVis software.

Modbus gateway

The ProData 2 can be set as a Modbus gateway with the following limitations:

- In this mode, the ProData 2 cannot be used as a Modbus RTU slave device.
- In this mode, the ProData 2 converts Modbus TCP packages from port 502 (only TCP) to Modbus RTU and sends these via the RS485 interface. If a response is received via the RS485 interface within a timeout period that can be set, this is converted to Modbus TCP again and sent via the IP connection.
- The ProData 2 can only forward queries (e.g. from the GridVis software) to a Modbus slave device. It **CANNOT** query Modbus slave devices independently.

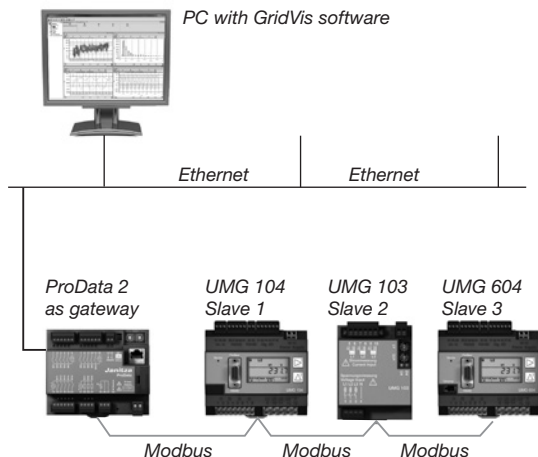

Fig.: Connection variant with ProData 2 as a gateway. The ProData 2 converts the queries of the GridVis software (TCP packages via Ethernet) for the Modbus slave devices (Modbus RTU) and forwards these via the RS485 interface (RS485 mode: Gateway; Addr. 3=1).

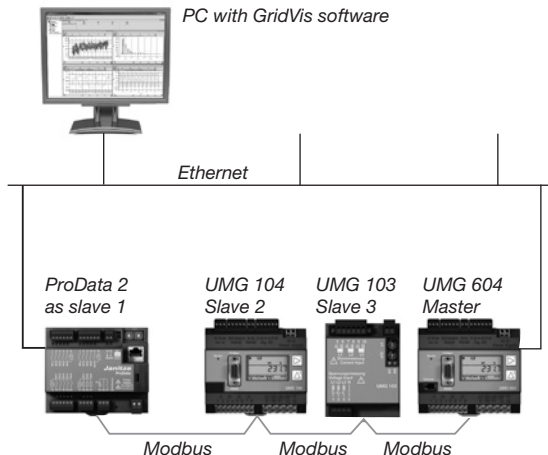

Fig.: Connection variant with ProData 2 as a Modbus RTU slave device.

The ProData 2 can be addressed directly via Ethernet but it cannot send any Ethernet queries to a Modbus slave device. The ProData 2 contains a slave function in the RS485 bus and can be read from the master device (UMG 604). (RS485 mode: Slave; Addr. 3=0).

Service and maintenance

The device underwent various safety checks before delivery and is marked with a seal. If a device is open, then the safety checks must be repeated. Warranty claims will only be accepted if the device is unopened.

Repairs

Repair work can be carried out by the manufacturer only.

Front film

The front film can be cleaned with a soft cloth and standard household cleaning agent. Do not use acids and products containing acid for cleaning.

Disposal

The ProData 2 can be reused or recycled as electronic scrap in accordance with the legal provisions. The permanently installed lithium battery must be disposed of separately.

Service

Should questions arise, which are not described in this manual, please contact the manufacturer directly.

We will need the following information from you to answer any questions:

- Device name (see rating plate),
- Serial number (see rating plate),
- Software release,
- Supply voltage,
- Precise description of the error.

Device calibration

The devices are calibrated by the manufacturer at the factory - it is not necessary to recalibrate the device providing that the environmental conditions are complied with.

Calibration

We recommend having a re-calibration carried out by the manufacturer or an accredited laboratory approximately every 5 years.

Battery

The internal clock is fed from the supply voltage. If the supply voltage fails then the clock is powered by the battery.

The clock provides date and time information, e.g. for the records and events.

The life expectancy of the battery is at least 5 years with a storage temperature of +45 °C. The typical life expectancy of the battery is 8 to 10 years.

The battery status (full capacity, undervoltage, no capacity) can be read via the Modbus (address 4942) / Ethernet using the GridVis software. If the battery is exhausted and no time synchronisation (NTP) is set, the software takes the last valid time stamp from the memory and resumes from there.

The following chapter provides information about changing the battery.

Modbus Address	Bit	Status description
4942 (short, 16-bit)	0	<ul style="list-style-type: none"> • Battery capacity exhausted • Clock has stopped and must be set if necessary • Battery should be replaced
	1	<ul style="list-style-type: none"> • Battery capacity nearly exhausted • Battery should be replaced
	2	<ul style="list-style-type: none"> • Battery capacity low • Battery should be replaced

*Table: Battery status
(can be read via Modbus in address 4942).*

Replacing the battery

If the battery capacity that is displayed by the GridVis software is in the "Undervoltage" range, we recommend changing the battery.

If the capacity of the battery is too low and a time synchronisation via NTP is not set, the device software takes the last valid time stamp and resumes it.

The battery is replaced via the battery insert provided on the front of the device. Ensure that the correct type of battery is used here and observe correct polarity when changing it. Information about polarity is provided on the battery insert cover.

Procedure

1. To change the battery, the device must be switched off.
2. Discharge any electrostatic charge in your body, e.g. by touching an earthed cabinet or metal part (radiator) connected to the earth of the building.
3. Open the battery compartment on the front of the device.
4. Remove the battery from the battery compartment, e.g. using long-nose pliers.

5. Ensure that the polarity is as shown on the battery compartment and slide the replacement battery into the battery compartment. Use a battery compliant with the description in the technical data for this. The battery must fulfil the safety requirements of UL1642. Otherwise, there is a risk of combustion or explosion.
6. Close the battery compartment with the relevant cover.
7. Dispose of the old battery according to the legal regulations.



Grease or dirt on the contact surfaces form a transfer resistance that will shorten the life of the battery. Only touch the battery at the edges.



Make sure that the correct type of battery is used and observe correct polarity when changing it.

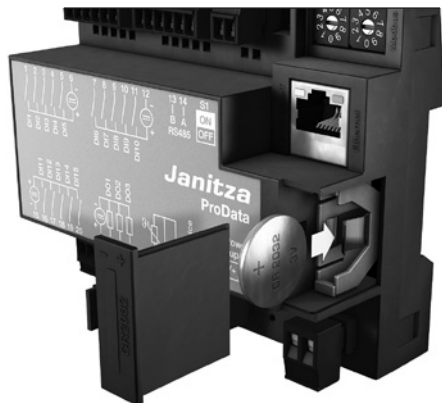

Fig. Battery insertion compartment on the front

Firmware update

If the device is connected to a computer via Ethernet (Modbus TCP) or the RS485 interface (Modbus RTU), the device firmware can be updated via the GridVis software.

The new firmware is transferred by selecting a suitable update menu (*Tools/Upgrade Devices* menu) and the device.

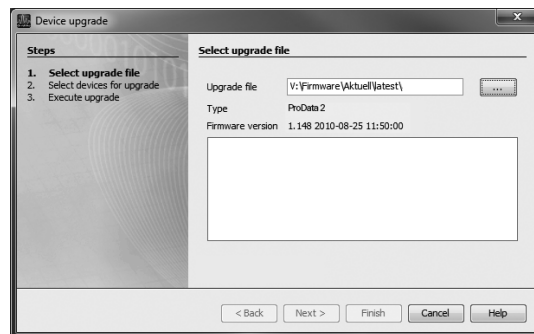

Fig. GridVis firmware update assistant

Procedure in the event of faults

Possible fault	Cause	Remedy
The device does not function	External fusing for the power supply voltage has tripped	Replace the fuse
Status LEDs illuminate RED and GREEN after the start process	Initialisation of the device terminated (see the chapter on LED device status)	Send the device to the manufacturer for inspection and testing along with an accurate fault description.
Status LED illuminates RED	Device defective	Send the device for inspection
No connection to the device (RS485)	Incorrect device address	Correct the device address
	Different bus speeds (baud rate)	Correct the speed (baud rate)
	Incorrect protocol	Correct the protocol
	Termination missing	Close bus with termination resistor
	Defective or faulty connection paths	Check connection paths
No connection to the device (Ethernet)	Incorrect addressing mode selected	Check addressing mode and correct if necessary
	Incorrect device address	Correct the device address
	Defective or faulty connection paths	Check connection paths and correct if necessary
Device still does not work despite the above measures.	Device defective.	Send the device to the manufacturer for inspection and testing along with an accurate fault description.

Technical data

General information	
Net weight (with attached connectors)	approx. 200 g
Packaging weight (including accessories)	approx. 440 g
Battery	Lithium battery CR2032, 3V (approval i.a.w. UL 1642)

Transport and storage	
The following information applies to devices which are transported or stored in the original packaging.	
Free fall	1 m
Temperature	K55 (-40 °C to +70 °C)
Relative humidity	0 to 90 % RH

Ambient conditions during operation	
The ProData 2 is intended for weather-protected, stationary use. Protection class II in acc. with IEC 60536 (VDE 0106, Part 1).	
Flammability rating of housing	UL 94V-0
Working temperature range	K55 (-40 °C to +55 °C)
Relative humidity	5 to 95 % RH (at +25 °C without condensation)
Operating altitude	0 .. 2000 m above sea level
Degree of pollution	2
Mounting / assembly	Mounting rails 35 mm (in acc. with IEC/EN60999-1, DIN EN 50022)
Mounting position	any
Ventilation	Forced ventilation is not required.
Protection against ingress of solid foreign bodies and water	IP20 in acc. with EN60529

Supply voltage	
Installation overvoltage category	300 V CAT II
Protection of the supply voltage	Fuse: 6 A, type CC (approved in acc. with UL/IEC) or Circuit breaker: 6 A, type C.Char
Nominal range	20 V - 250 V (45..65 Hz) or DC 20 V - 300 V
Power consumption	max. 4 VA / 2 W

Terminal connection capacity (supply voltage)	
Conductors to be connected. Only one conductor can be connected per terminal!	
Single core, multi-core, fine-stranded	0.2 - 2.5 mm ² , AWG 26 - 12
Terminal pins, core end sheath	0.2 - 2.5 mm ²
Tightening torque	0.4 - 0.5 Nm
Stripping length	7 mm

Digital outputs, DIN EN 62053-31:1998 (IEC 62053-31:1998 class B)	
3 digital outputs, semiconductor relays, not short-circuit proof.	
Operating voltage	20 V - 30 V DC (SELV or PELV supply)
Switching voltage	max. 60 V DC
Switching current	max. 50 mAeff DC
Pulse output (energy pulse)	max. 20 Hz
Pulse output	in acc. with DIN EN 62053-31:1998 (IEC 62053-31:1998 class B)

Digital inputs	
15 digital inputs, semiconductor relays, not short-circuit proof.	
Operating voltage	20 V - 30 V DC (SELV or PELV supply)
Input signal present (signal "1")	> 18V DC (typical 4 mA for 24 V)
Input signal not present (signal "0")	< 5V DC
Pulse input (S0), maximum count frequency	25 Hz
Pulse input ¹	in acc. with DIN EN 62053-31:1998 (IEC 62053-31:1998 class B)

Note about digital inputs:

¹ To operate the device in accordance with DIN EN 62053-31 (S0), a resistor with 1.3 kOhm/1 W must be connected parallel to the input.

Temperature measurement input	
1 input (3-wire measurement).	
Update time	1 second
Connectable sensors	PT100, PT1000, KTY83, KTY84
Total burden (sensor + cable)	max. 4 kOhm

Sensor type	Temperature range	Resistor range	Uncertainty in measurement
KTY83	-55 °C ... +175 °C	500 Ohm ... 2.6 kOhm	± 1.5% rng
KTY84	-40 °C ... +300 °C	350 Ohm ... 2.6 kOhm	± 1.5% rng
PT100	-99 °C ... +500 °C	60 Ohm ... 180 Ohm	± 1.5% rng
PT1000	-99 °C ... +500 °C	600 Ohm ... 1.8 kOhm	± 1.5% rng

Cable length: Digital inputs and outputs, temperature measurement input	
Up to 30 m	Unshielded
More than 30 m	Shielded

Terminal connection capacity: Digital inputs and outputs, temperature measurement input	
Rigid/flexible	0.20 - 1.5 mm ² , AWG 28-16
Flexible with core end sheath without plastic sleeve	0.20 - 1.5 mm ²
Flexible with core end sheath with plastic sleeve	0.20 - 1.5 mm ²
Tightening torque	0.20 - 0.25 Nm
Stripping length	7 mm

Serial interface	
RS485 - Modbus RTU/Slave	9.6 kbps, 19.2 kbps, 38.4 kbps, 57.6 kbps, 115.2 kbps
Stripping length	7 mm

Terminal connection capacity (serial interface)	
Single core, multi-core, fine-stranded	0.20 - 1.5 mm ²
Terminal pins, core end sheath	0.20 - 1.5 mm ²
Tightening torque	0.20 - 0.25 Nm
Stripping length	7 mm

Ethernet connection	
Connection	RJ45
Functions	Modbus gateway
Protocols	TCP/IP, DHCP Client (BootP), Modbus/TCP (Port 502), ICMP (Ping), NTP

Clock	
Precision	+/- 5 ppm in temperature range -40 °C to 70 °C (corresponding to approx. 3 minutes p.a.)

Dimension diagrams

All dimensions provided in mm

ProData 2 front view

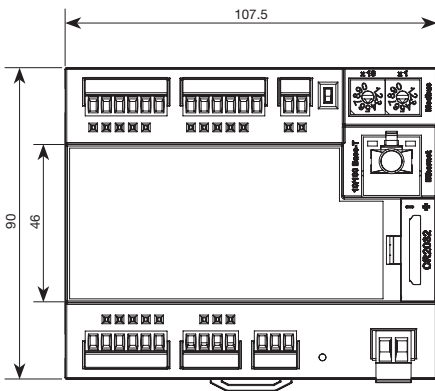

ProData 2 side view

with Ethernet connector inserted

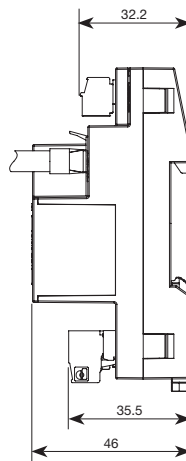

Declaration of conformity

The product fulfils the following EC Directives:	
2004/108/EG	Electromagnetic compatibility of electrical equipment.
2006/95/EG	Electrical equipment for use within certain voltage limits.
Considered standards:	
Noise immunity IEC/EN 61326-1:2013 IEC/EN 61000-4-2:2009 IEC/EN 61000-4-3:2011, EMV-ILA V01-03 IEC/EN 61000-4-3:2011, EMV-ILA V01-03 IEC/EN 61000-4-4:2013, EMV-ILA V01-03 IEC/EN 61000-4-5:2007, EMV-ILA V01-03 IEC/EN 61000-4-6:2009, EMV-ILA V01-03 IEC/EN 61000-4-11:2005, EMV-ILA V01-03	Class A: Industrial environment Electrostatic discharge Electromagnetic RF Field 80-1000MHz Electromagnetic RF Field 1000-2700MHz Burst Surge Conducted disturbances 0.15-80MHz Voltage dips, short interrupts, voltage variations and frequency changes
Noise emission IEC/EN 61326-1:2013 IEC/CISPR11/EN 55011:2011 IEC/CISPR11/EN 55011:2011 EMV-ILA V01-03	Class B: Residential environment Radio disturbance field strength 30-1000MHz Radio disturbance voltage 0.15-30MHz Radio disturbance voltage 9-150kHz
Equipment safety IEC/EN 61010-1:2011 IEC/EN 61010-2-030:2011	Safety requirements for electrical equipment for Measurement, control and laboratory use – Part 1: General requirements Particular requirements for testing and measuring circuits

optec

energie ist messbar

Optec AG | Guyer-Zeller-Strasse 14 | CH-8620 Wetzikon ZH

Telefon: +41 44 933 07 70 | Telefax: +41 44 933 07 77

E-Mail: info@optec.ch | Internet: www.optec.ch

Connection example

