



FULLTEST³

User's manual



INDEX:

1. SAFETY PRECAUTIONS AND PROCEDURES	3
1.1 PRELIMINARY INSTRUCTIONS.....	4
1.2. DURING USE	4
1.3. AFTER USE	5
1.4. OVERVOLTAGE CATEGORIES - DEFINITIONS.....	5
2. GENERAL DESCRIPTION	6
2.1. WORKING	6
2.2. OPENING THE INSTRUMENT'S COVER.....	8
3. PREPARATION FOR USE	9
3.1 PRELIMINARY CHECKS	9
3.2. POWER SUPPLY	9
3.3. CALIBRATION.....	9
3.4. TRANSPORT AND STORAGE.....	9
4. OPERATING INSTRUCTIONS	10
4.1. INSTRUMENT - DESCRIPTION	10
4.2. TURNING ON THE TESTER.....	11
4.3. MEASUREMENT FUNCTION SELECTION	12
5. MEASUREMENTS.....	13
5.1. CONTINUITY - TWO WIRE METHOD (RPE-2WIRE).....	13
5.1.1. RPE-2WIRE DISPLAY EXPLANATION.....	13
5.1.2. CALIBRATION OF TEST LEADS.....	14
5.1.3. LIMIT VALUE ADJUSTMENT.....	15
5.1.4. RPE-2WIRE MEASUREMENT.....	16
5.2. CONTINUITY - FOUR WIRE METHOD (RPE-4WIRE).....	18
5.2.1 RPE-4WIRE DISPLAY EXPLANATION.....	18
5.2.2. CALIBRATION OF TEST LEADS.....	19
5.2.3. RPE-4WIRE MEASUREMENT.....	19
5.3. INSULATION RESISTANCE (M Ω).....	21
5.3.1. RISO DISPLAY EXPLANATION	21
5.3.2. RISO MEASUREMENT	22
5.4. DIELECTRIC (DIELECTRIC).....	24
5.4.1. WARNINGS	24
5.4.2. DIELECTRIC DISPLAY EXPLANATION.....	25
5.4.3. DIELECTRIC TEST.....	26
5.5. RCD (RCD).....	29
5.5.1. RCD DISPLAY EXPLANATION	29
5.5.2. EXPLANATION OF RCD TEST CURRENTS	30
5.5.3. RCD MEASUREMENT	31
5.6. LOOP IMPEDANCE / SHORT-CIRCUIT CURRENT (LOOP)	33
5.6.1. LOOP DISPLAY EXPLANATION.....	33
5.6.2. LIMIT VALUE EXPLANATION	34
5.6.3. PROSPECTIVE SHORT-CIRCUIT CURRENT CALCULATION	35
5.6.4. LOOP MEASUREMENT	36
5.7. GLOBAL EARTH RESISTANCE / CONTACT VOLTAGE (RA).....	38
5.7.1. RA LIMIT VALUE CALCULATION	39
5.7.2. RA DISPLAY EXPLANATION	39
5.7.3. RA MEASUREMENT	40
5.8. RESIDUAL VOLTAGE (URES).....	42
5.8.1 EXPLANATION OF LINEAR MODE.....	42
5.8.2. EXPLANATION OF NONLINEAR MODE.....	43
5.8.3. URES DISPLAY EXPLANATION	44
5.8.4. TRIGGER CONDITIONS	44
5.8.5. URES MEASUREMENT	45
5.9. POWER (POWER).....	48

5.9.1 POWER DISPLAY EXPLANATION	48
5.9.2. POWER MEASUREMENT.....	49
5.10. PHASE SEQUENCE (PHASESEQ).....	51
5.10.1. PHASE SEQUENCE DISPLAY EXPLANATION.....	51
5.10.2. PHASE SEQUENCE MEASUREMENT.....	52
5.11. CURRENT MEASUREMENT USING CURRENT CLAMP (ICLAMP).....	53
5.11.1. ICLAMP DISPLAY EXPLANATION	53
5.11.2. ICLAMP MEASUREMENT	54
5.12. LEAKAGE CURRENT (ILEAK)	55
5.12.1. LEAKAGE CURRENT DISPLAY EXPLANATION.....	55
5.12.2. LEAKAGE CURRENT MEASUREMENT USING CURRENT CLAMP.....	57
5.12.3. LEAKAGE CURRENT MEASUREMENT ON SCHUKO SOCKET	58
6. MENU FUNCTIONS	60
6.1. MEMORY menu	60
6.1.1. MEMORY INFO menu	60
6.1.2. CLEAR menu.....	61
6.1.3. USB menu	61
6.2. OPERATOR menu.....	61
6.3. LANGUAGE menu	62
6.4. TESTER INFO menu	62
6.5. SETUP menu	63
6.5.1. LEVEL NAMES menu	63
6.5.2. CONTACT VOLTAGE menu	64
6.5.3. DATE/TIME menu	64
6.5.4. RESET menu.....	64
6.5.5. NOMINAL VOLTAGE menu.....	69
6.5.6. SAFETY menu.....	69
6.6. SOUND menu.....	70
7. MEMORY FEATURES.....	71
7.1. MEMORY STRUCTURE	71
8. MEMORIZING EXAMPLE	72
9. RECALL RESULTS.....	74
10. ENTRY OF DATA BY USING AN EXTERNAL KEYBOARD.....	75
11. ENTRY OF DATA BY USING A BARCODE READER.....	75
12. FW UPDATE OF THE FULLTEST 3.....	77
13. MAINTENANCE.....	77
13.1. CLEANING	77
13.2. FUSE REPLACEMENT.....	77
14. TECHNICAL SPECIFICATIONS	79
14.1. MEASUREMENT FUNCTIONS.....	79
14.2. GENERAL SPECIFICATION.....	89
14.3. ACCESSORIES	89
15. SERVICE	90
15.1. WARRANTY CONDITIONS	90
15.2. AFTER-SALE SERVICE.....	90

1. SAFETY PRECAUTIONS AND PROCEDURES

CAUTION







For your own safety and to avoid damaging the instrument follow the procedures described in this instruction manual and read carefully all notes marked with this symbol.

This instrument complies with safety Standards EN61557 and EN61010-1 related to electronic measuring instruments. When taking measurements:

- ☞ Avoid doing this in humid or wet places - make sure that humidity is within the limits indicated in section "Environmental conditions".
- ☞ Avoid doing this in rooms where explosive gas, combustible gas, steam or excessive dust is present.
- ☞ Keep you insulated from and do not touch the object under test, any exposed metal part such as test lead ends, sockets, fixing objects, circuits etc.
- ☞ Avoid doing this if you notice anomalous conditions such as breakages, deformations, fractures, blind display etc.

The following symbols are used in this instruction manual:

	Warning of a potential danger, comply with instruction manual.
	Reference, please pay utmost attention.
UUT	Unit under test
	Caution, dangerous voltage. Danger of electrical shock.
	Symbol for marking of electrical and electronic equipment (WEEE Directive).
	Conformity symbol, the instrument complies with the valid directives. It complies with the EMC Directive and the Low Voltage Directive.

1.1 PRELIMINARY INSTRUCTIONS

CAUTION



The instrument must be connected to a power socket with grounded PE terminal. If this is not assured, the instrument will display PE DISCONNECTED, SWITCH OFF NOW message and will perform no measurement.

- ☞ The instruction manual contains information and references, necessary for safe operation and maintenance of the instrument. Prior to using the instrument, the user is kindly requested to thoroughly read the instruction manual and comply with it in all sections.
- ☞ Failure to read the instruction manual or to comply with the warnings and references contained herein can result in serious bodily injury or instrument damage.
- ☞ In order to avoid electrical shock, the valid safety and national regulations regarding excessive contact voltages must receive utmost attention when working with voltages exceeding 60 V DC or 50 V (25 V) RMS AC. The value in brackets is valid for limited ranges (as for example medicine).
- ☞ The operator is recommended to respect the usual safety regulations aimed at protecting against dangerous currents and protecting the instrument against improper use.
- ☞ This instrument has been designed for use in environments of pollution degree 2.
- ☞ It can be used for tests on electrical installations of overvoltage category III, 300V maximum voltage to earth.
- ☞ Do not effect measurements on circuit exceeding the specified voltage limits.
- ☞ Only the original test leads supplied along with the instrument guarantee compliance with the safety standards in force. They must be in good conditions and, if necessary, replaced with identical ones.
- ☞ Do not take measurements under environmental conditions exceeding the limits indicated in this manual.
- ☞ Before connecting the test probes to the installation make sure that the right function is selected.
- ☞ The instrument may only be used in dry and clean environments. Dirt and humidity reduce insulation resistance and may lead to electrical shocks, in particular for high voltages.
- ☞ Never use the instrument in precipitation such as dew or rain. In case of condensation due to temperature jumps, the instrument may not be used.
- ☞ Start any test series by earth bond resistance measurement.
- ☞ At earth bond resistance, insulation resistance and dielectric measurements unit under test must be voltage-free. If necessary check the unit is voltage-free i.e. by using a voltage tester.
- ☞ When modifying the instrument, the operational safety is no longer ensured.

1.2. DURING USE

CAUTION



An improper use may damage the instrument and/or its components or injure the operator.

- ☞ Only skilled technicians, who know the possible risks involved to the dangerous voltages use are allowed to operate the instrument.
- ☞ The instrument may only be connected to mains voltage as indicated on the type shield.

- ☞ The instrument may only be used within the operating ranges as specified in the technical data section.
- ☞ Disconnect the test leads from the circuit under test before selecting any function.
- ☞ Only touch test leads and test probes at handle surface provided. Never directly touch test probes.
- ☞ Never touch any unused terminal when the instrument is connected to circuits.
- ☞ Do not measure resistance in presence of external voltages; although the instrument is protected, an excessive voltage may cause malfunctioning.
- ☞ Do not open the instrument! Dangerous voltages inside!
- ☞ Connecting one terminal to the test object and working with one probe or holding both probes in one hand is prohibited.
- ☞ Use safety probes with protection against contact or with two-hand operation only. Always hold only one probe in one hand.
- ☞ It is prohibited to touch the unit under test during the test. If need be, additional measures must be taken (e.g. cover made of insulating mats) to protect the person performing the test against inadvertent contact with the unit under test.

1.3. AFTER USE

Disconnect all test leads from the circuit under test and switch off the instrument.

1.4. OVERVOLTAGE CATEGORIES - DEFINITIONS

Standard EN61010-1 (Safety requirements for electrical equipment for measurement, control and laboratory use, Part 1: General requirements) defines what a measurement category (usually called as Overvoltage Category) is. At paragraph 6.7.4: Measuring circuits it says:

(OMISSIS)

Circuits are divided into the following measurement categories:

- **Measurement category IV** is for measurements performed at the source of the low-voltage installation.
Examples are electricity meters and measurements on primary overcurrent protection devices and ripple control units.
- **Measurement category III** is for measurements performed in the building installation.
Examples are measurements on distribution boards, circuit breakers, wiring, including cables, bus-bars, junction boxes, switches, socket-outlets in the fixed installation, and equipment for industrial use and some other equipment, for example, stationary motors with permanent connection to fixed installation.
- **Measurement category II** is for measurements performed on circuits directly connected to the low voltage installation.
Examples are measurements on household appliances, portable tools and similar equipment.
- **Measurement category I** is for measurements performed on circuits not directly connected to MAINS.
Examples are measurements on circuits not derived from MAINS, and specially protected (internal) MAINS-derived circuits. In the latter case, transient stresses are variable; for that reason, the norm requires that the transient withstand capability of the equipment is made known to the user.

2. GENERAL DESCRIPTION

Dear Customer, the instrument you have purchased, whether used according to the instructions given in this manual, will grant you accurate and reliable measurements. Thanks to a development of newest conception assuring overvoltage category III you will enjoy the highest safety.

The Machinery Tester FULLTEST 3 is a measurement instrument used for final inspection of electrical equipment of machines, control cabinets, switchgears as well as other devices complying with IEC/EN60204-1 and IEC/EN61439-1 standards.

2.1. WORKING

The instrument can carry out the following tests, further to the regulations listed below:

<ul style="list-style-type: none"> • Continuity of protective conductor <ul style="list-style-type: none"> - 2-wire or 4-wire measurement method. - Compensation of test leads in case of 2-wire measurement. - Open-circuit test voltage 6 V AC approx. - Test current 200 mA and 25 A AC. - Limit value adjustable, visual and acoustic warning in case of exceeded value. 	EN61557-4 EN61439-1-§10.5.2 EN60204-1-§18.2.2 EN60598-1 EN60335-1-§27.5 EN60335-1-§A.1 EN50106 EN60950 CEI 64-8/7-CEI64/13
<ul style="list-style-type: none"> • Insulation resistance <ul style="list-style-type: none"> - Test voltage 100 V, 250 V, 500 V and 1000 V DC. - MAN (manual) mode. - TIMER mode. - AUTO mode. - Limit value adjustable, visual and acoustic warning in case of exceeded value. 	EN61557-2 CEI64-8 CEI23-51 CEI64-8/7-CEI64/13 EN61439-1-§11.9 EN60204-1 EN60598-1
<ul style="list-style-type: none"> • Dielectric test <ul style="list-style-type: none"> - Adjustable test voltage 250 V up to 5100 V AC. - Trip out current adjustable 1 ÷ 110 mA, visual and acoustic warning in case of exceeded limit value. - Display and trip out based on real or apparent current. - MANUAL mode. - RAMP 75% mode (predefined automatic rising of test voltage). - RAMP 50% mode (predefined automatic rising of test voltage). - BURN mode. - Protection against unauthorised use (safety measure). - Red warning lamp connector (safety measure). - Safety input connector (safety measure). 	EN61439-1-§9.1 EN60204-1-§18.4 EN60598-1 EN60335-1-§13.3 EN60335-1-§A.2

<ul style="list-style-type: none"> • RCD test <ul style="list-style-type: none"> - AC, A and B type. - General, selective and delayed characteristic. - Voltage range 100 ... 265 V. - Limit contact voltage 25 or 50 V. - $I_{\Delta N} = 10, 30, 100, 300, 500, 650$ or 1000 mA. - Trip out time at $I_{\Delta N}/2$ (AC, A and B type). - Trip out time at $I_{\Delta N}$ (AC, A and B type). - Trip out time at $2I_{\Delta N}$ (AC and A type). - Trip out time at $5I_{\Delta N}$ (AC and A type) or at $4I_{\Delta N}$ (B type). - Ramp test (AC, A and B type). - AUTO test (AC, A and B type). - Visual and acoustic warning in case of exceeded limit value. 	EN61557-6
<ul style="list-style-type: none"> • Loop impedance measurement <ul style="list-style-type: none"> - $Z_{L/N}$, $Z_{L/L}$ and $Z_{L/PE}$ measurement. - Voltage range 100 ÷ 460 V. - IPSC calculation. - Limit value adjustable, visual and acoustic warning in case of exceeded value. 	EN60204-1-§18.2 EN61557-3
<ul style="list-style-type: none"> • Global earth resistance <ul style="list-style-type: none"> - Selectable test current with regard to involved RCD. - $I_{\Delta N} = 10, 30, 100, 300, 500, 650$ or 1000 mA. - Measurement with $I_{\Delta N}/2$ (without tripping out RCD) - Voltage range 100 ÷ 265 V. - Contact voltage U_C measured during the measurement. - Limit value (RA) fixed to 25 or 50 V/$I_{\Delta N}$, visual and acoustic warning in case of exceeded value. 	
<ul style="list-style-type: none"> • Residual voltage <ul style="list-style-type: none"> - Measurement on power plug (2-wire method). - Measurement on internal components (4-wire method). - Limit discharge time 1 s or 5 s. - LINEAR or NONLINEAR mode. - Visual and acoustic warning in case of exceeded limit value. 	EN60204-1-§18.5
<ul style="list-style-type: none"> • Power (on schuko socket) <ul style="list-style-type: none"> - Apparent power P_{APP}. - Real power P. - Mains voltage $U_{L/N}$. - Load current I_L. - Power factor PF. - Leakage current I_{PE} (differential method). - Internal phase position exchange. - Limit value (apparent power) adjustable, visual and acoustic warning in case of exceeded value. 	
<ul style="list-style-type: none"> • Phase sequence <ul style="list-style-type: none"> - Mains voltages $U_{L1/2}$, $U_{L2/3}$, $U_{L3/1}$ simultaneously displayed. 	EN61557-7

<ul style="list-style-type: none"> • Clamp current <ul style="list-style-type: none"> - Measurement in combination with HT96U current clamp. - Three ranges 1 A, 100 A and 1000 A. - Limit value adjustable, visual and acoustic warning in case of exceeded value. 	
<ul style="list-style-type: none"> • Leakage current <ul style="list-style-type: none"> - Measurement of IPE current on schuko socket (differential method). - Measurement with current clamp type HT96U, three ranges 1 A, 100 A and 1000 A. - Limit value adjustable, visual and acoustic warning in case of exceeded value. 	
<ul style="list-style-type: none"> • GENERAL advantages <ul style="list-style-type: none"> - Portable Machinery & Panel Tester constructed according to the IEC/EN60204-1 and IEC/EN61439-1 standards. - Operation system WINDOWS EMBEDDED COMPACT 7 supports all measurements and operations. - Easy and clear operation by using the touch screen and intuitive hard keys. - TRMS measurements. - Data memory for 999 measurement results, three levels (e.g. CUSTOMER, LOCATION, MACHINE) plus additional COMMENT. - Real time clock included. - Integrated interface (USB 2.0) for transfer of measurement results to PC. - Separate interface (USB 2.0) for connection of USB barcode reader, USB keyboard, USB memory stick, printer or IMP57-impedance tester. - Graphic colour touch screen 102×60 mm, 480×272 dots. - Compact housing with external accessory bag. - Quick connection diagrams and limit values under the instrument cover. - Fuse protection in case of overload. - PC Software TOP VIEW available. - Complete test accessories included. - Bluetooth communication. - Remote START/STOP and SAVE function. 	

2.2. OPENING THE INSTRUMENT'S COVER

The instrument is built in a robust plastic case that allows comfortable transport. We recommend the user to follow the next opening instructions:

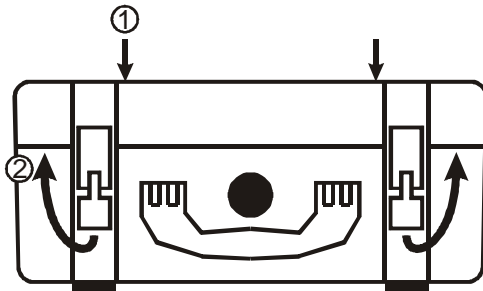

Figure 1: Opening the instrument's cover

- Place the unit on to a hard horizontal surface.
- Press on the case cover with your hands, see the mark 1.
- Unlock the fixing hooks of the cover, see the mark 2.
- Open the cover into vertical position.

3. PREPARATION FOR USE

3.1 PRELIMINARY CHECKS

This instrument was checked both mechanically and electrically prior to shipment. All possible cares and precautions were taken to let you receive the instrument under perfect conditions. Notwithstanding we suggest you to check it rapidly (possible damages may have occurred during transport – if so please contact the local distributor from whom you purchased the item).

Make sure all standard accessories according to Packing List are included.

Should you have to return back the instrument for any reason please follow the instructions mentioned in paragraph “3.4. TRANSPORT AND STORAGE”.

3.2. POWER SUPPLY

Earthed plugs must energize the instrument. To avoid any risk the instrument does not allow to effect measurements when there is not such a connection (refer to paragraph “4.2. TURNING ON THE TESTER” for details).

3.3. CALIBRATION

The instrument complies with the technical specifications contained in this manual and such a compliance is guaranteed for 1 year. Annual recalibration is recommended.

3.4. TRANSPORT AND STORAGE

Please keep the original packaging for potential later transport, e.g. for calibration. Any transport damage due to faulty packaging will be excluded from warranty claims.

Instruments must be stored in dry and closed areas. In case of an instrument being transported in extreme temperatures, a recovery time of minimum 2 hours is required prior to instrument operation.

4. OPERATING INSTRUCTIONS

4.1. INSTRUMENT - DESCRIPTION

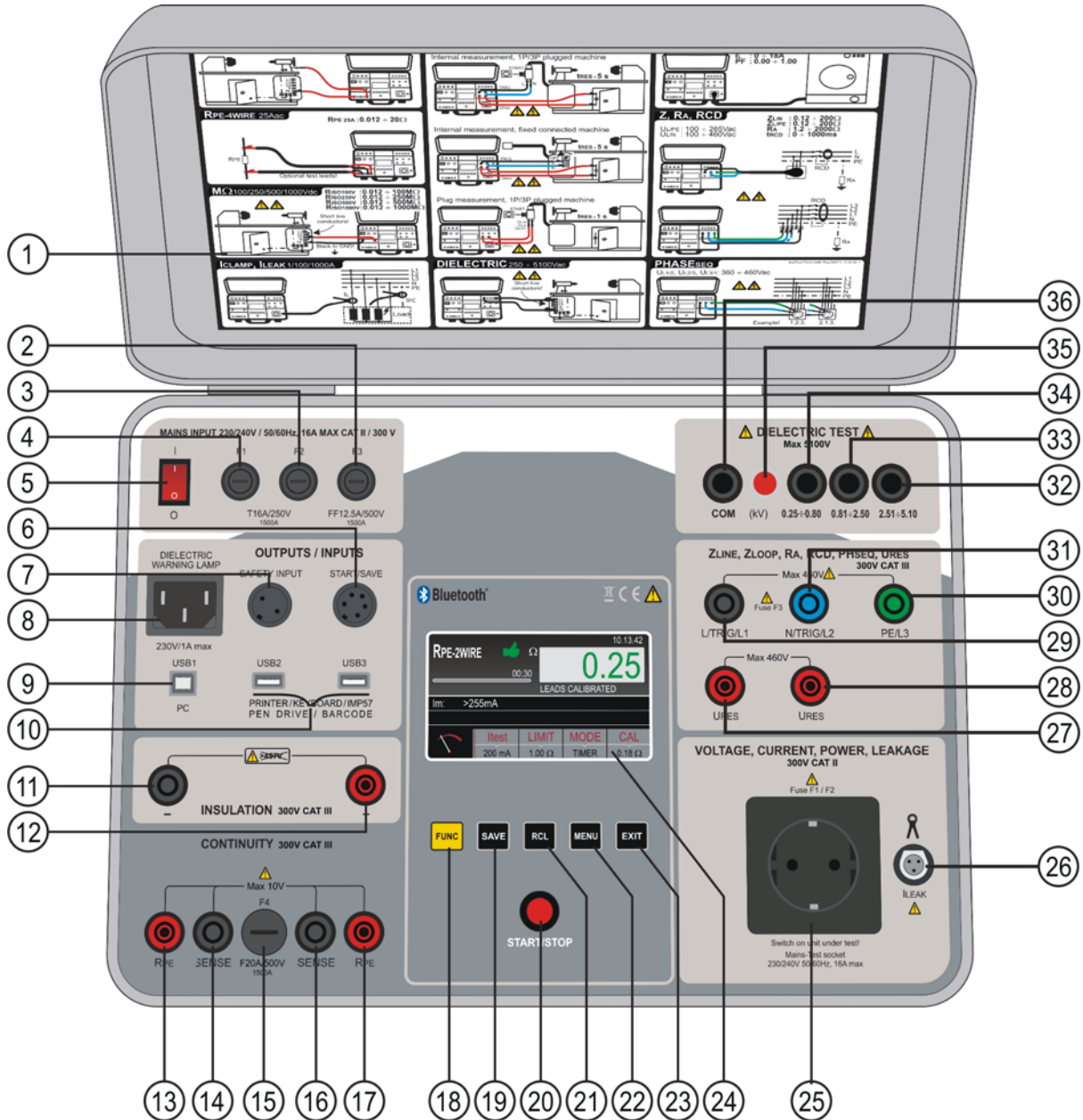

Figure 2: Instrument description

LEGEND

- 1 Quick instruction label under the cover.
- 2 Fuse F3, type T12.5A/500V 6.3×32 mm which protects internal circuitry in LOOP, RA and RCD measurements.
- 3 General tester fuse F2, type T16A/250V 5×20 mm which protects internal circuitry in POWER, RPE and DIELECTRIC measurements.
- 4 General tester fuse F1, type T16A/250V 5×20 mm which protects internal circuitry in POWER, RPE and DIELECTRIC measurements.

- 5 ON/OFF mains switch (with red pilot lamp).
- 6 Connector for START/SAVE remote control adapter.
- 7 Connector SAFETY INPUT for connection of external safety switch (for example protection door). It disables DIELECTRIC tests in case the switch is open.
- 8 IEC female connector for connection of red WARNING LAMP in DIELECTRIC test. The lamp is active when the test is on (parallel operation to HV lamp on front panel, reference 35).
- 9 USB 1 connector for connection with PC.
- 10 USB 2 and USB 3 connectors for connection of USB stick, USB barcode reader, USB printer, USB keyboard or IMP57 impedance meter.
- 11 Negative RISO terminal.
- 12 Positive RISO terminal.
- 13 RPE current generator terminal.
- 14 SENSE voltage terminal.
- 15 Fuse F4, type F20A/500V 6.3×32 mm which protects internal circuitry in RPE measurement.
- 16 SENSE voltage terminal.
- 17 RPE current generator terminal.
- 18 FUNC hard key to select appropriate measurement function.
- 19 SAVE hard key to save test result.
- 20 START/STOP button which starts or stops selected measurement.
- 21 RCL hard key to recall saved result.
- 22 MENU hard key to open MAIN MENU.
- 23 EXIT hard key to exit existing screen and return it one step back.
- 24 Colour LCD touch-screen display.
- 25 Mains test socket for POWER and LEAKAGE measurement.
- 26 CLAMP connector for HT96 current clamp.
- 27 URES measurement terminal.
- 28 URES measurement terminal.
- 29 L/TRIG/L1 terminal for LOOP, RA, RCD, PHASE SEQUENCE and URES measurements.
- 30 PE/L3 terminal for LOOP, RA, RCD and PHASE SEQUENCE measurements.
- 31 N/TRIG/L2 terminal for LOOP, RCD, PHASE SEQUENCE and URES measurements.
- 32 DIELECTRIC test terminal for test voltages 2.51 ÷ 5.10 kV.
- 33 DIELECTRIC test terminal for test voltages 0.81 ÷ 2.50 kV.
- 34 DIELECTRIC test terminal for test voltages 0.25 ÷ 0.80 kV.
- 35 DIELECTRIC on lamp. It lights when DIELECTRIC test is running.
- 36 DIELECTRIC COM (common) test terminal.

4.2. TURNING ON THE TESTER

After switching on mains switch (5) the tester will upload WINDOWS first (it will take 30 s approx.), then last used measurement screen will appear. A beep-beep sound signal will be given as soon as the tester is ready for measurements.



CAUTION

In case energizing socket is not earthed properly PE DISCONNECTED message will appear and the tester will not perform any further operation. In this case switch off the tester immediately and check the energizing socket!

4.3. MEASUREMENT FUNCTION SELECTION

Press the **FUNC** hard key (yellow), the function selection screen will appear.

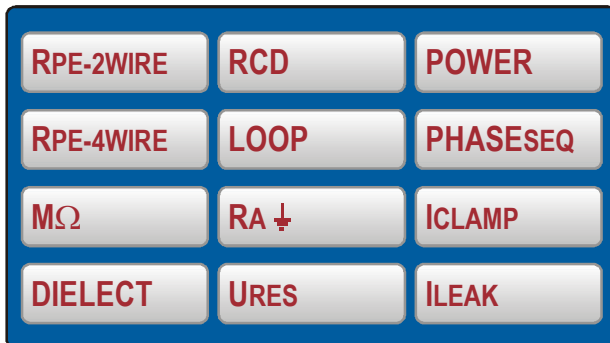

Figure 3: Function selection screen

Select wished function by pressing appropriate touch-screen key, basic measurement screen of selected function will appear, see an example of RPE-2WIRE basic measurement screen below. Other functions use adapted screens, but follow the same system.

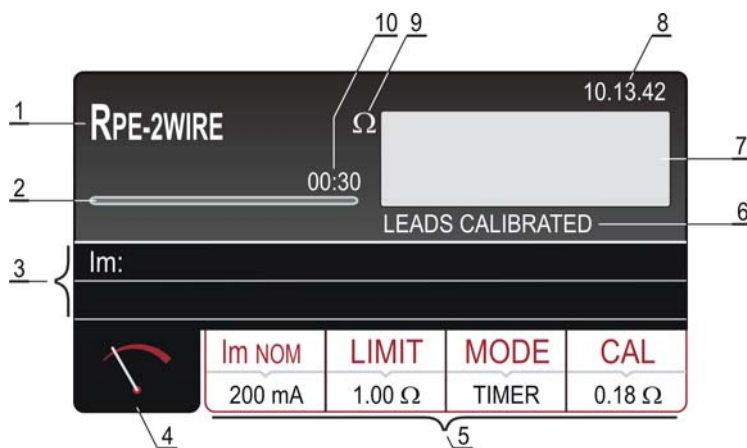

Figure 4: Basic measurement screen in RPE-2WIRE function

- 1..... Selected function.
- 2..... Progress bar, it follows measurement time during the measurement (in TIMER mode only).
- 3..... Two lines reserved for sub-results (no value in basic screen yet).
- 4..... Measurement screen touch-screen key.
- 5..... Measurement parameters touch-screen keys.
- 6..... Test lead calibration status (LEADS CALIBRATED or LEADS NOT CALIBRATED).
- 7..... Measurement result field (result in green colour - OK, result in red colour - not OK, result in white colour – not judged).
- 8..... Real time clock (hh.mm.ss).
- 9..... Unit of the measurement result.
- 10... Set measurement time (in TIMER mode only).

5. MEASUREMENTS

5.1. CONTINUITY - TWO WIRE METHOD (RPE-2WIRE)

- Complying with EN 60204-1, continuity of protective bonding circuit between PE terminal and relevant points of the protective conductor system must be checked by injecting a measurement current of 0.2 A up to 10 A approx.

5.1.1. RPE-2WIRE DISPLAY EXPLANATION

Adjustable/selectable parameters:

Im NOM - nominal meas. Current	200 mA or 25 A AC
LIMIT (meas. current 200 mA) - continuity limit value	0.01 ÷ 19.99, 20.0 ÷ 200.0 Ω
LIMIT (meas. current 25 A) - continuity limit mode	STANDARD, 60204 SET Z or 60204 SET L
LIMIT (test current 25 A, STANDARD mode) - continuity limit value	0.01 ÷ 20.00 Ω
MODE - measurement mode	MANUAL or TIMER
CAL (meas. current 200 mA) - calibration of test leads	0.00 ÷ 5.00 Ω
CAL (meas. current 25 A) - calibration of test leads	0.000 ÷ 1.999, 2.00 ÷ 5.00 Ω
TIMER - measurement time	00:01 ÷ 60:00 (1 s ÷ 60 min), resolution 1 s
LENGTH - wire length	0.1 ÷ 999.9 m, resolution 0.1 m
SECTION - wire section	1, 1.5, 2.5, 4, 6, 10, 16, 25, 35, 50, 70, 95, 120, 150, 185, 240, 300, 400, 500 o 630 mm ²
MATERIAL - wire material	Cu (Copper) or Al (Aluminium)
ZLINE - input line impedance	0.001 ÷ 2.000 Ω, resolution 0.001 Ω
PROTECTION - over-current protection device	MCB B, MCB C, MCB D, MCB K, FUSE gG or FUSE aM
IN - nominal current of protection device	Depends on selected protection device, see the chapter 5.1.3. LIMIT VALUE ADJUSTMENT

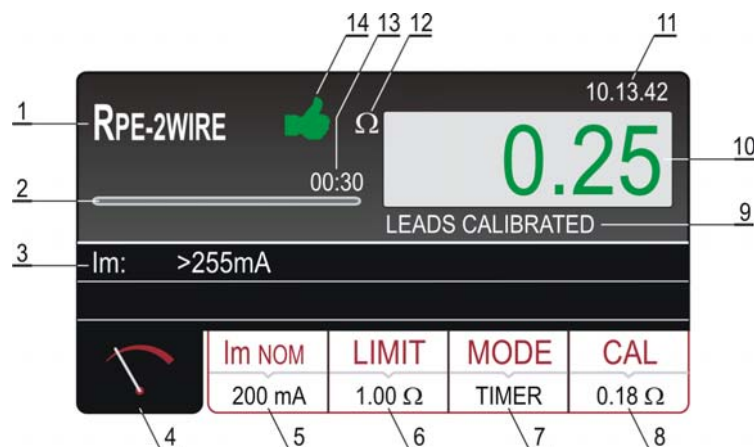





Figure 5: Display with RPE-2WIRE test result

- Selected function.
- Progress bar, it follows measurement time during the measurement (in TIMER mode only).
- Sub-result - measurement current Im that was flowing through UUT during the measurement.
- Measurement screen touch-screen key.

- 5..... **Im NOM** touch-screen key to select nominal test current (200 mA or 25 A). Currently selected value is displayed on the bottom of the key.
- 6..... **LIMIT** touch-screen key to select limit value (200 mA measurement) or limit mode (25 A measurement). Currently selected value or CALC is displayed on the bottom of the key. CALC message means the value is calculated.
- 7..... **MODE** touch-screen key to select operation mode (MANUAL or TIMER). Currently selected mode is displayed on the bottom of the key. TIMER mode is available in 200 mA measurement and in 25 A measurement if STANDARD limit mode is selected.
- 8..... **CAL** touch-screen key to carry out calibration of test leads. Currently calibrated value is displayed on the bottom of the key. In case of no calibration, the value 0.00 Ω is displayed in red colour.
- 9..... Test lead calibration status (LEADS CALIBATED or LEADS NOT CALIBRATED).
- 10... Measurement value (in green colour - result OK, in red colour - result not OK).
- 11... Real time clock (hh.mm.ss).
- 12... Unit of measurement result (Ω).
- 13... Set measurement time (in TIMER mode only).
- 14... Measurement result status (symbol  in green colour - result OK, symbol  in red colour - result not OK or symbol  in yellow colour – result OK, but measurement current too low).

5.1.2. CALIBRATION OF TEST LEADS

In order test leads not to influence the test results, resistance of the leads must be calibrated (zeroed). Follow the next steps to calibrate test lead's resistance:

- 1) Select test current that will be used for later measurement (200 mA or 25 A) by pressing the **Im NOM** touch-screen key (5) first.
- 2) Press the **CAL** touch-screen key (8), the message "SHORTCIRCUIT TEST LEADS AND PRESS START TO CALIBRATE" will appear.
- 3) Connect test leads according to the figure below, make sure two crocodiles are connected as close as possible to each other to a piece of unisolated wire.

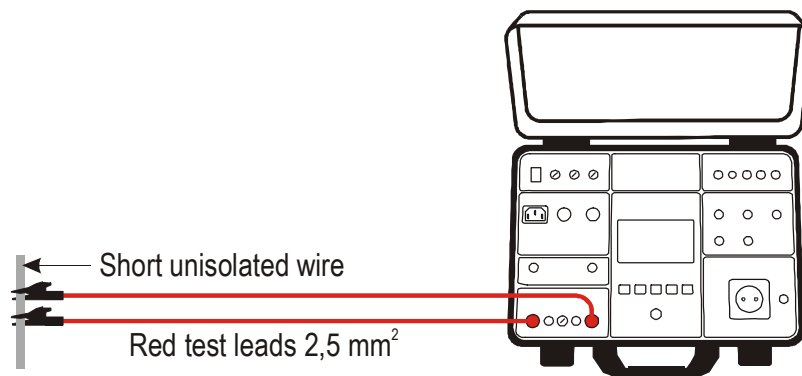

Figure 6: Connection of test leads for calibration purpose

- 4) Press the **START** button. The measurement will be done and value without calibration will be displayed for a moment, then the value will be set to zero (0.00). Test leads are thus calibrated, measurements can follow.

CAUTION



- The calibration must be done separately for each test current (200 mA and 25 A)!
- The calibration must be repeated when test leads are changed (replaced, shortened or extended)!
- Max resistance that can be calibrated is 5 Ω!
- Existing calibration can be annulled if test leads are opened when calibration is carried out!
- Calibration is not needed in RPE-4WIRE function!

The following specific information may be shown on the display during calibration:

Information displayed	Description
SHORTCIRCUIT TEST LEADS AND PRESS START KEY TO CALIBRATE	Calibration has been started (CAL touch-screen key has been pressed). <i>Shortcircuit test leads and press the START button!</i>
OPEN TEST LEADS, CALIBRATION ANNULED	Test leads are opened after pressing the START button. <i>Press YES key ... existing calibration will be annulled!</i> <i>Press NO key ... existing calibration will stay untouched!</i>
RPE > 5 Ω CALIBRATION FAILED	Connected resistance is higher than 5 Ω and lower than measurement range, calibration can not be carried out. Existing calibration will stay untouched. <i>Reduce external resistance and repeat the calibration!</i>

5.1.3. LIMIT VALUE ADJUSTMENT

Test current 200 mA is selected:

Limit value can be selected within the range from 0.01 up to 200.0 Ω in steps of 0.01 Ω.

Test current 25 A is selected:

There are three possibilities to select the limit value.

- **STANDARD** selection.

Limit value can be selected within the range from 0.01 up to 20.00 Ω in steps of 0.01 Ω.

- **EN60204 SET L** selection.

Limit value is calculated on bases of wire length (L), wire section (SECTION) and wire material (MATERIAL), where the parameters can be selected/adjusted within the following ranges:

- L (length) 0.1 up to 999.9 m in steps of 0.1 m
- SECTION (wire section) 1, 2.5, 4, 6, 10, 16, 25, 35, 50, 70, 95, 120, 150, 185, 240, 300, 400, 500 or 630 mm²
- MATERIAL (wire material) Cu (Copper) or Al (Aluminium)

- **EN60204 SET Z** selection.

Limit value is calculated on bases of entered line impedance (ZLINE), type of protection (TYPE), nominal current (In) and wire section (SECTION), where the parameters can be selected within the following ranges:

- ZLINE (line impedance) 0.001 Ω up to 2.000 Ω in steps of 0.001 Ω
- TYPE (type of protection) MCB B, MCB C, MCB D, MCB K, FUSE gG or FUSE aM
- In (nominal current)
 - 6, 10, 13, 16, 20, 25, 32, 40, 50 or 63 A (MCB B)
 - 0.5, 1, 1.6, 2, 4, 6, 10, 13, 16, 20, 25, 32, 40, 50 or 63 A (MCB C)
 - 0.5, 1, 1.6, 2, 4, 6, 10, 13, 16, 20, 25 or 32 A (MCB D, MCB K)
 - 2, 4, 6, 8, 10, 12, 16, 20, 25, 32, 40, 50, 63, 80, 100, 125, 160, 200, 250, 315, 400, 500, 630, 800, 1000 or 1250 A (FUSE gG)

	- 2, 4, 6, 8, 10, 12, 16, 20, 25, 32, 40, 50, 63, 80, 100, 125, 160, 200, 250, 315, 400, 500 or 630 A (FUUSE aM)
SECTION (wire section)	1, 2.5, 4, 6, 10, 16, 25, 35, 50, , 70, 95, 120, 150, 185, 240, 300, 400, 500 o 630 mm ²
-	

5.1.4. RPE-2WIRE MEASUREMENT

Measured quantities and display ranges:

Resistance RPE	0 ÷ 200 Ω (nominal test current 200 mA) 0 ÷ 20 Ω (nominal test current 25 A)
Measurement current Im	10 ÷ 255 mA (nominal test current 200 mA) 0.2 ÷ 30.0 A (nominal test current 25 A)

- 1) Select the RPE-2WIRE measurement by pressing the **FUNC** hard key first.
- 2) Check selected test current (200 mA or 25 A) and modify it if needed by pressing the **Im NOM** (5) touch-screen key first.
- 3) Check selected limit value and modify it if needed by pressing the **LIMIT** (6) touch-screen key first. Four independent preset limit values are available in STANDARD limit mode selection for quicker operations. Select the one closest to wished value and modify it by using the **+** and **-** touch screen keys if needed.
- 4) Check selected mode (MANUAL or TIMER) and modify it if needed by pressing the **MODE** (7) touch-screen key first. In MANUAL mode the measurement will start after pressing the **START/STOP** button and will stop after pressing the **START/STOP** button again. In TIMER mode the measurement will start after pressing the **START/STOP** button and will stop after elapsing set measurement time or after pressing the **START/STOP** button again.
- 5) Check the status of test lead calibration and carry out the calibration if needed, see the instructions in chapter "CALIBRATION OF TEST LEADS" above.
- 6) Select measurement screen by pressing the  (4) touch-screen key and check all settings again.
- 7) Connect the test leads according to the figure below.

CAUTION

 Before connecting test leads to UUT obligatory assure there is no external voltage higher than 10 V between the test points where test leads will be connected to, otherwise fuse F4 may blow!

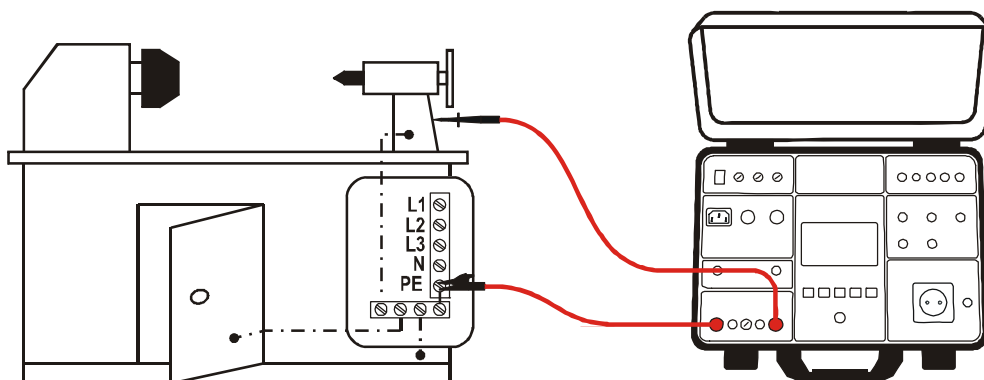



Figure 7: Connection of test leads in RPE-2WIRE function

- 8) Carry out the measurement by pressing the **START/STOP** button. Test result will currently be displayed in green (result lower than or equal to set limit value) or in red colour (result higher than set limit value). Final result will be equipped with green  symbol and with beep-beep sound

(result OK) or with red symbol and with longer beep sound (result not OK) or with yellow symbol and with beep-beep sound (result OK, but measurement current was too low). See the display outlook with test result on figure 5.

- 9) Save the test result by pressing the **SAVE** hard key twice, for further instructions see the “MEMORIZING EXAMPLE” section.

CAUTION



- **Max external voltage between two RPE or between two SENSE test terminals is 10 VAC, no DC external voltage is allowed! In case of higher external voltage fuse F4 (T20A/500V, 6.3×32 mm) may blow!**
- **Measurement time in MANUAL mode is limited to 60 min!**

The following specific information can be shown on the display during measurement:

Information displayed	Description
CHECK CALIBRATION	Measurement result is negative probably because of shorter test leads than calibrated (negative value is higher than 5 digits). <i>Calibrate test leads again!</i>
EXTERNAL VOLTAGE	<ul style="list-style-type: none"> • External voltage higher than 3 V is applied between two RPE or between two SENSE test terminals (measurement is not running) or higher than 10 V (measurement is running). • External voltage higher than 5 ÷ 30 V is applied between any RPE or SENSE test terminal and GND. <i>Remove external voltage!</i>
LIMIT OUT OF RANGE	Calculated limit value is < 1 (EN60204 SET Z limit mode).
FUSE F4!	Fuse F4 is blown.
ERROR 1!	Internal fuse may be blown! <i>The fuse is not customer replaceable, send the tester into a service department.</i>

5.2. CONTINUITY - FOUR WIRE METHOD (RPE-4WIRE)

- Complying with EN 60204-1, continuity of protective bonding circuit between PE terminal and relevant points of the protective conductor system must be checked by injecting a measurement current of 0.2 A up to 10 A approx.
- Limit values are the values which correspond to the length, cross section and material of measured conductor.

5.2.1 RPE-4WIRE DISPLAY EXPLANATION

Adjustable/selectable parameters:

LIMIT - continuity limit mode	STANDARD, 60204 SET Z or 60204 SET L
MODE - measurement mode	MANUAL or TIMER
TIMER – measurement time	00:01 ÷ 60:00, resolution 1 s
LENGTH - wire length	0.1 ÷ 999.9 m, resolution 0.1 m
SECTION - wire section	1, 1.5, 2.5, 4, 6, 10, 16, 25, 35, 50, 70, 95, 120, 150, 185, 240, 300, 400, 500 o 630 mm ²
WIRE - wire material	Cu (Copper) or Al (Aluminium)
ZLINE - input line impedance	0.001 ÷ 2.000 Ω, resolution 0.001 Ω
PROTECTION - over-current protection device	MCB B, MCB C, MCB D, MCB K, FUSE gG or FUSE aM
In - nominal current of protection device	Depends on selected protection device, see the chapter 5.1.3. LIMIT VALUE ADJUSTMENT

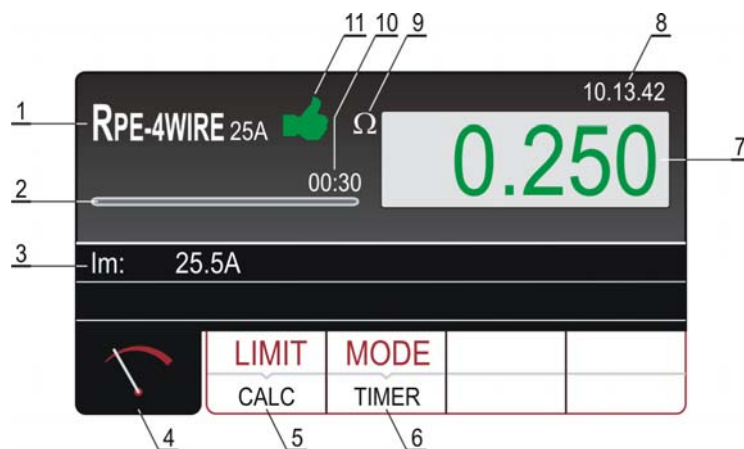



Figure 8: Display with RPE-4WIRE test result

- Selected function.
- Progress bar, it follows measurement time during the measurement (in TIMER mode only).
- Measurement current flowing through UUT during the measurement.
- Measurement screen touch-screen key.
- **LIMIT** touch-screen key to select limit mode (STANDARD, 60204 SET Z or 60204 SET L). Currently selected value (STANDARD mode) or CALC (60204 SET Z or 60204 SET L mode) is displayed on the bottom of the key. CALC message means the value is calculated.
- **MODE** touch-screen key to select operation mode (MANUAL or TIMER). Currently selected mode is displayed on the bottom of the key. TIMER mode is available only if STANDARD limit mode is selected.

- 7..... Measurement value (in green colour - result lower than or equal to set limit value, in red colour - result is higher than set limit value).
- 8..... Real time clock (hh.mm.ss).
- 9..... Unit of measurement result (Ω).
- 10... Set measurement time (in TIMER mode only).
- 11... Measurement result status (symbol  in green colour - result OK, symbol  in red colour – result not OK).

5.2.2. CALIBRATION OF TEST LEADS

The calibration is not needed because of 4-wire method.

5.2.3. RPE-4WIRE MEASUREMENT

Measured quantities and display ranges:

Continuity RPE	$0 \div 20 \Omega$
Test current	$0.2 \div 30 \text{ A}$

- 1) Select the RPE-4WIRE function by pressing the **FUNC** hard key first.
- 2) Check selected limit value and modify it if needed by pressing the **LIMIT** (6) touch-screen key first. Four independent preset limit values are available in STANDARD limit mode selection for quicker operations. Select the one closest to wished value and modify it by using the + and – touch screen keys if needed.
- 3) Check selected mode and modify it if needed by pressing the **MODE** (7) touch-screen key first.
- 4) Select measurement screen by pressing the  (4) touch-screen key and check all settings again.
- 5) Connect the test leads according to the figure below.

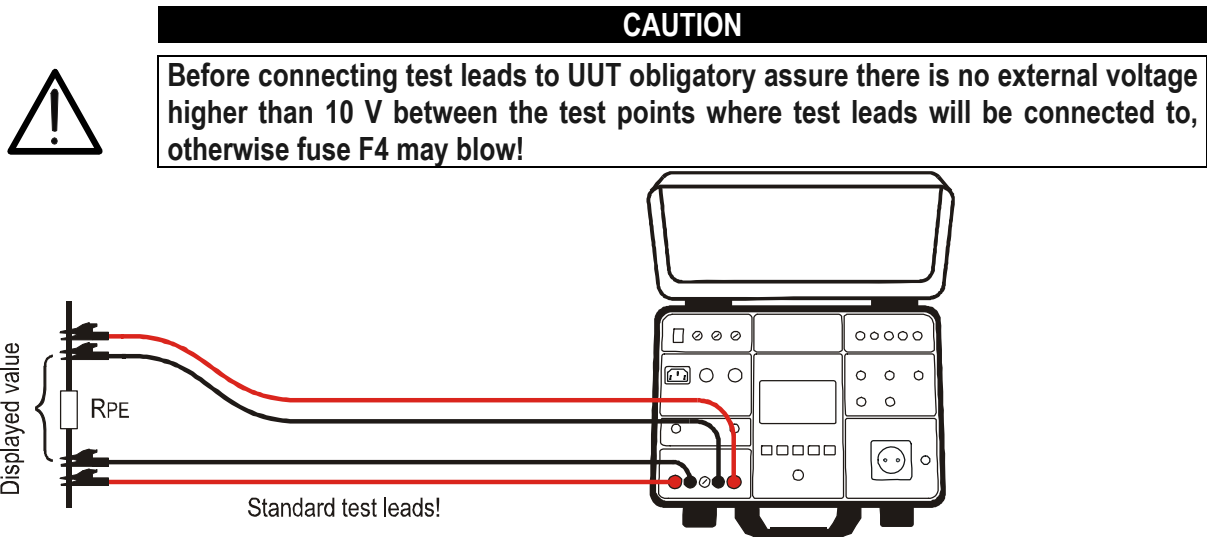

Figure 9: Connection of standard test leads

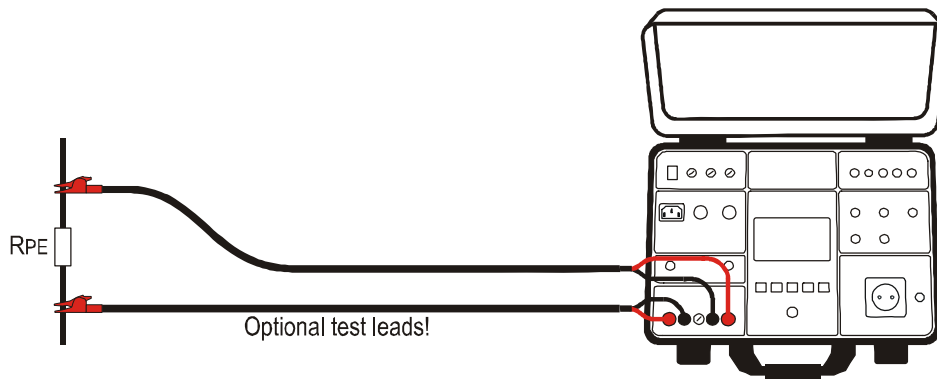

Figure 10: Connection of optional Kelvin test leads

- 6) Carry out the measurement by pressing the **START/STOP** button. The measurement will start to run and will be stopped after pressing the **START/STOP** button again (MANUAL mode) or after elapsing set measurement time (TIMER mode).
Test result will currently be displayed in green (result lower than or equal to set limit value) or in red colour (result is higher than set limit value). Final result will be equipped with green symbol and with beep-beep sound (result OK) or with red symbol and with longer beep sound (result not OK). See the display outlook with test result on figure 8.
- 7) Save the test result by pressing the **SAVE** hard key twice, for further instructions see the “MEMORIZING EXAMPLE” section.

CAUTION

- **Max external voltage between two RPE or between two SENSE test terminals is 10 VAC, no DC external voltage is allowed! In case of higher external voltage fuse F4 (T20A/500V, 6.3×32 mm) may blow!**
- **If SENSE test leads are not connected, then measurement result will include also the resistance of current test leads.**
- **Measurement time in MANUAL mode is limited to 60 min!**

The following specific information can be shown on the display during measurement:

Information displayed	Description
EXTERNAL VOLTAGE	<ul style="list-style-type: none"> • External voltage higher than 3 V AC is applied between two RPE or between two SENSE test terminals (measurement is not running) or higher than 10 V AC (measurement is running). • External voltage higher than 5 ÷ 30 V is applied between any RPE or SENSE test terminal and GND. <i>Remove external voltage!</i>
FUSE F4!	Fuse F4 is blown.
EROR1!	Internal fuse may be blown! <i>The fuse is not customer replaceable, send the tester into a service department.</i>

5.3. INSULATION RESISTANCE (MΩ)

- According to EN 60204-1, the insulation resistance between shorted active conductors of power circuit and the earth bonding system must be checked by applying a test voltage of 500 V DC. The limit value is 1 MΩ.
- Ensure that all switches on the unit under test are closed in order to test all its components. For purpose of the measurement, all active conductors (L1, L2, L3 and N) must be shortcircuited.

5.3.1. Riso DISPLAY EXPLANATION

Adjustable/selectable parameters:

U _{test} - nominal test voltage	100, 250, 500 or 1000 V DC
MODE - operation mode	MANUAL, TIMER or AUTO
LIMIT - insulation resistance limit	0.01 ÷ 100.0 MΩ
TIMER – measurement time	00:05 ÷ 10:00, res. 1 s

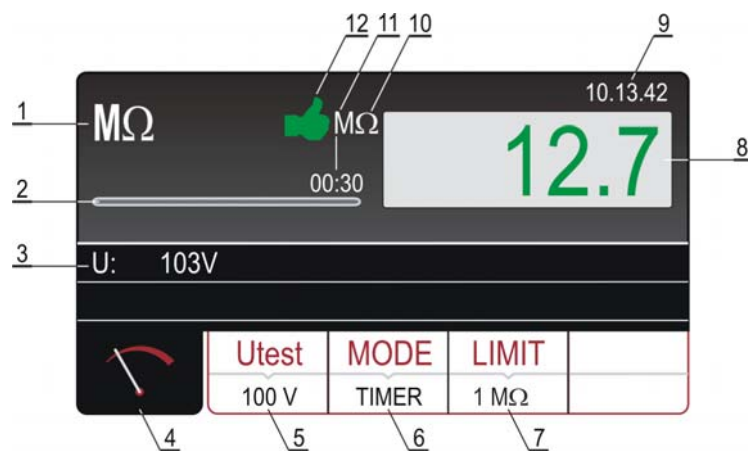



Figure 11: Display with RISO test result

- Selected function.
- Progress bar, it follows measurement time during the measurement (in TIMER mode only).
- Test voltage applied during the measurement.
- Measurement screen touch-screen key.
- **Utest** touch-screen key to select nominal test voltage (100, 250, 500 or 1000 V). Currently selected value is displayed on the bottom of the key.
- **MODE** touch-screen key to select operation mode (MANUAL, TIMER or AUTO). Currently selected mode is displayed on the bottom of the key.
- **LIMIT** touch-screen key to select limit insulation resistance. Currently selected value is displayed on the bottom of the key.
- Measurement value (in green colour - result OK, in red colour - result not OK).
- Real time clock (hh.mm.ss).
- Unit of the measurement result (MΩ).
- Set measurement time (in TIMER mode only).
- Measurement result status (symbol in green colour - result OK, symbol in red colour - result not OK).

5.3.2. Riso MEASUREMENT

Measured quantities and display ranges:

Insulation resistance RINS	0 ÷ 100 MΩ (test voltage 100 V)
	0 ÷ 250 MΩ (test voltage 250 V)
	0 ÷ 500 MΩ (test voltage 500 V)
	0 ÷ 1000 MΩ (test voltage 1000 V)
Test voltage U _{test}	0 ÷ 1100 V

- 1) Select MΩ function by pressing the **FUNC** hard key first.
- 2) Check selected test voltage (100, 250, 500 or 1000V) and modify it if needed by pressing the **Utest** (5) touch-screen key first.
- 3) Check selected mode and modify it if needed by pressing the **MODE** (6) touch-screen key first. MANUAL, TIMER or AUTO mode can be selected.
- 4) Check selected limit value and modify it if needed by pressing the **LIMIT** (7) touch-screen key first. Four independent preset limit values are available for quicker operations. Select the one closest to wished value and modify it by using the **+** and **-** touch screen keys if needed.
- 5) Select measurement screen by pressing the  (4) touch-screen key and check all settings again.
- 6) Connect the test leads according to the figure below.

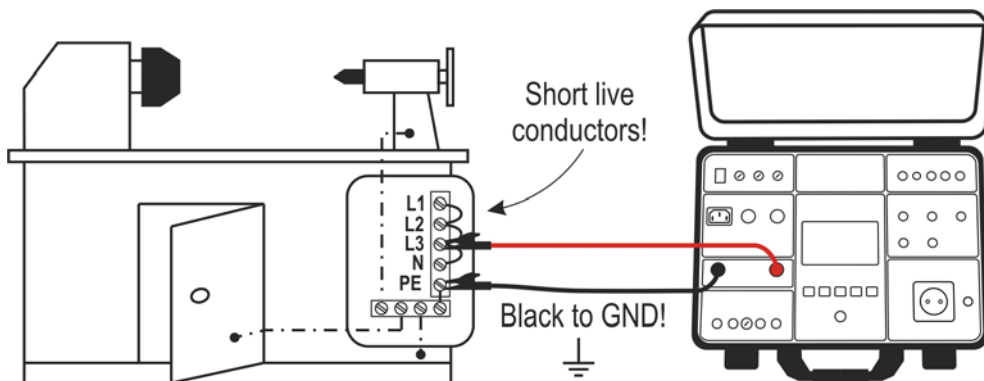





Figure 12: Connection of test leads

- 7) Carry out the measurement by pressing the **START/STOP** button. The measurement will start to run and will be stopped after pressing the **START/STOP** button again (MANUAL mode) or after elapsing set measurement time (TIMER mode) or after reaching stable result (AUTO mode). Test result will currently be displayed in green colour (result higher than or equal to set limit value) or in red colour (result lower than set limit value). Final result will be equipped with green  symbol and with beep-beep sound (result OK) or with red  symbol and with longer beep sound (result not OK). See the display outlook with test result on figure 11.
- 8) Save the test result by pressing the **SAVE** hard key twice, for further instructions see the "MEMORIZING EXAMPLE" section.

CAUTION

- Connect COM test lead to chassis if the UUT is grounded. In case of reversed test leads measurement result may be affected by instrument's internal resistance of 10 MΩ!
- Due to the measurement of insulation resistance, capacitive UUT will be charged with test voltage. The UUT will be discharged after finishing the measurement via internal resistance of approx. 2 MΩ. The UUT can retain dangerous voltage in case of premature removal of test leads. Ensure that the UUT is discharged through the measurement instrument (not through short circuit)!
- Measurement time in MANUAL mode is limited to 60 min!

The following specific information can be shown on the display during the measurement:

Information displayed	Description
 EXTERNAL VOLTAGE	<ul style="list-style-type: none"> • External voltage higher than 10 V AC approx. is applied between positive and negative test terminals (measurement is not running) or higher than 50 V AC approx. (measurement is running). • Negative external voltage higher than 10 V DC approx. is applied between positive and negative test terminals (measurement is running). <i>Remove external voltage!</i>
DISCHARGING!	External capacitor (or internal) that was charged during the measurement is discharging. <i>Wait until the message disappears! Do not disconnect test leads until the message is present!</i>

5.4. DIELECTRIC (DIELECTRIC)

- According to EN 60204-1, electric equipment must withstand a voltage test between shortcircuited active conductors of power circuit and the earth bonding system for approx. 1 s.
- The test shall be carried out at twice the rated supply (or 1000 V whichever is greater) 50 Hz. Components not rated for this test voltage may be disconnected before carrying out the test.

5.4.1. WARNINGS



WARNING, DANGER OF ELECTRICAL SHOCK

The Machine Tester FULLTEST 3 supplies high voltage of a dangerous power. According to EN 50191 the following precautionary measures must be taken prior to a test:

- Block access to danger area.
- Put up warning signs (Attention! High voltage, danger to life).
- Install warning lamps (red, green) to be easily visible.
- Install EMERGENCY-OFF switch into the mains installation outside the dangerous area.
- Electrical trained personnel may only do the tests under supervision of specialist staff and have to be trained regularly.
- Use safety probes with protection against contact or with two-hand operation only. Always hold only one probe in one hand.
- Connecting one test terminal to the UUT and working with one probe or holding both probes in one hand is prohibited.
- It is prohibited to touch the unit under test during the test. If need be, additional measures must be taken (e.g. cover made of insulating mats) to protect the person performing the test against inadvertent contact with the test object.

Testing may commence only after all safety measures were taken.

Ensure that all switches on the UUT are closed in order to test all it's components. For the purpose of measurement all active conductors (L1, L2, L3 and N) must be shortcircuited.

5.4.2. DIELECTRIC DISPLAY EXPLANATION

Adjustable/selectable parameters:

MODE - operation mode	MANUAL, BURN, RAMP 75% or RAMP 50%
U _{TEST NOM} - nominal test voltage	250 ÷ 5100 V AC
LIMIT - current limit	1 ÷ 110 mA
CHAR - current character	I _{APP} or I _{REAL}
TIMER (RAMP test only) – measurement time	00:01 ÷ 10:00, res. 1 s

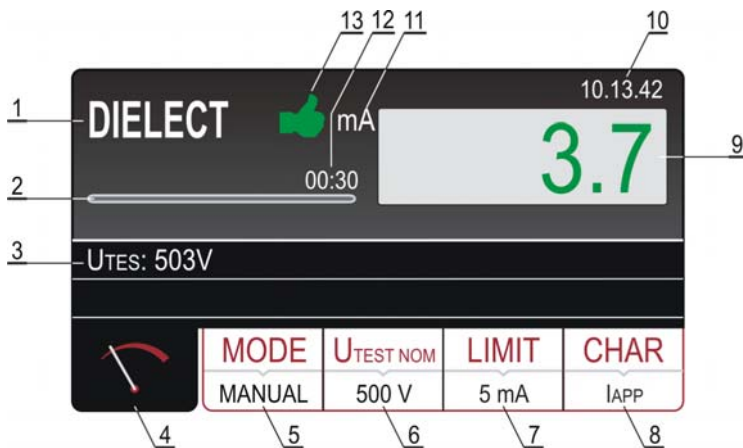



Figure 13: Display with DIELECTRIC test result

- 1..... Selected function.
- 2..... Progress bar, it follows test time during the measurement (in RAMP mode only).
- 3..... Test voltage applied during the measurement.
- 4..... Measurement screen touch-screen key.
- 5..... **MODE** touch-screen key to select operation mode (MANUAL, BURN, RAMP 75% or RAMP 50%). Currently selected mode is displayed on the bottom of the key.
- 6..... **U_{TEST NOM}** touch-screen key to select nominal test voltage (250 up to 5100 V AC). Currently selected value is displayed on the bottom of the key.
- 7..... **LIMIT** touch-screen key. Currently selected limit leakage current (trip out current) is displayed on the bottom of the key.
- 8..... **CHAR** (character) touch-screen key to select the character of displayed leakage current (I_{APP} or I_{REAL}). Currently selected character is displayed on the bottom of the key.
- 9..... Leakage current in green colour if the result is lower than or equal to set limit value. If break-through occurred during the test then limit value will be displayed in red colour.
- 10... Real time clock (hh.mm.ss).
- 11... Unit of the test result (mA).
- 12... Set measurement time (in RAMP mode only).
- 13... Measurement result status (symbol  in green colour - result lower than or equal to set limit value, symbol  in red colour - break through occurred during the test or result higher than set limit value).

5.4.3. DIELECTRIC TEST

Measured quantities and display ranges:

Apparent leakage current I_{APP} 0 ÷ 200 mA
 Real leakage current I_{REAL} 0 ÷ 200 mA
 Test voltage 250 ÷ 5.100 V

Explanation of measurement modes:

MANUAL or BURN mode:

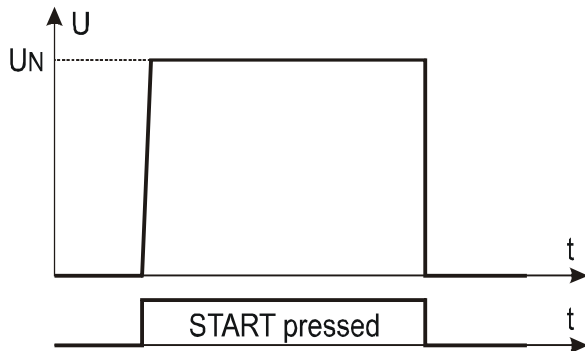

Figure 14: Presence of test voltage with regard to pressed START button in MANUAL or BURN mode

RAMP 75% mode:

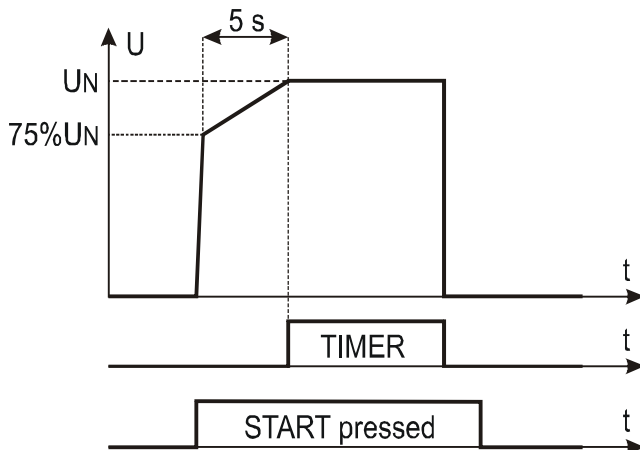

Figure 15: Presence of test voltage with regard to pressed START button and set time in RAMP 75% mode

RAMP 50% mode:

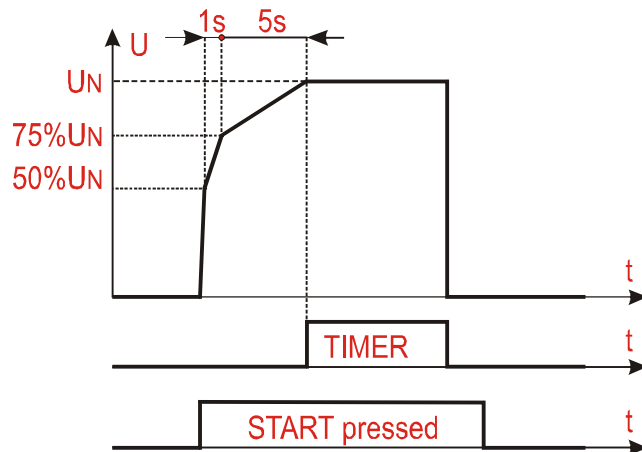

Figure 16: Presence of test voltage with regard to pressed START button and set time in RAMP 50% mode

- 1) Select DIELECTRIC measurement by pressing the **FUNC** hard key first.
- 2) Check selected mode and correct it if needed by pressing the **MODE** (5) touch-screen key first. MANUAL, RAMP or BURN mode can be selected.
- 3) Check selected test voltage (250 up to 5100V) and correct it if needed by pressing the **UTES NOM** (6) touch-screen key first.
- 4) Check selected limit current and correct it if needed by pressing the **LIMIT** (7) touch-screen key first. Four independent preset limit currents are available for quicker operations. Select the one closest to wished value and modify it by using the **+** and **-** touch screen keys if needed.
- 5) Check selected character of displayed current (IAPP or IREAL) and correct it if needed by pressing the **CHAR** (8) touch-screen key first.
- 6) Select measurement screen by pressing the (4) touch-screen key and check all settings again.
- 7) Connect the test leads according to the figure below.

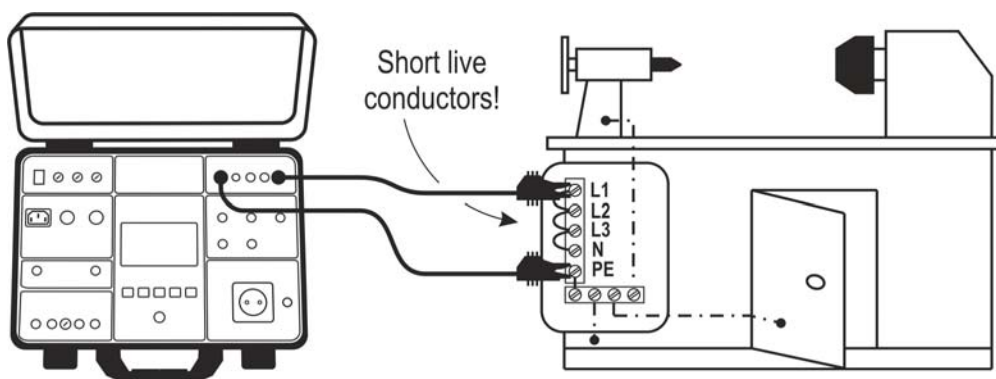



Figure 17: Connection of test leads

- 8) Carry out the test by pressing the **START/STOP** button. Warning with explanation of how to connect test leads with regard to selected test voltage will be displayed. Check the connection then confirm it by pressing the **YES** touch-screen key, the message "READY" will appear and will stay present for 10 seconds. **START/STOP** button is active while "READY" message is present. Press and keep pressing the **START/STOP** button, test voltage will be applied to test terminals.

The test will be stopped after releasing the **START/STOP** button (MANUAL or BURN mode) or after elapsing set test time (RAMP mode).

Test result will currently be displayed in green colour if it is lower than or equal to set limit value.

Final result will be equipped with green  symbol and with beep-beep sound (result OK). If break through occurred during the test then the test will be stopped and limit test current will be displayed in red colour equipped with red  symbol and with longer beep sound. See the display outlook with test result on the figure 13.

- 9) Save test result by pressing the **SAVE** hard button twice, for further instructions see the “MEMORIZING EXAMPLE” section.

SAFETY INPUT

In order to reach higher level of safety the SAFETY INPUT connector is installed. Safety switch of a mechanical barrier can be connected there in order to disable DIELECTRIC function in case the safety switch is opened. For this purpose select SAFETY INPUT enabled mode in the menu as follows:

MENU hard key → **SETUP** touch-screen key → **SAFETY** touch-screen key → **ENABLED** touch-screen key.

WARNING LAMP

According to EN 50191 the highest level of safety must be undertaken when working with high voltages like used in DIELECTRIC test. For this purpose the FULLTEST 3 offers an output to drive the high voltage warning lamp. Use only the lamps supplied by original supplier of the FULLTEST 3 tester.

CAUTION



- Always connect COM terminal to GND if measured UUT is grounded, otherwise possible capacitive leakage current may flow to ground which may disturb the measurement!
- Measurement time in MANUAL mode is limited to 60 min!

The following specific information can be shown on the display during measurement:

Information displayed	Description
 EROR1!	Internal fuse may be blown! <i>The fuse is not customer replaceable, send the tester into a service department.</i>

5.5. RCD (RCD)

5.5.1. RCD DISPLAY EXPLANATION

Adjustable/selectable parameters:

TYPE - type of RCD	AC, A or B
CHARACTERISTIC - RCD characteristic	GENERAL, SELECTIVE or DELAYED
$I_{\Delta N}$ - nominal differential current	10, 30, 100, 300, 500, 650 or 1000 mA
MEAS - type of measurement	$t/1/2I_{\Delta N}$, $t/I_{\Delta N}$, $t/2I_{\Delta N}$, $t/5I_{\Delta N}$, I_{Δ} or AUTO
POL - test current polarity	POS (positive) or NEG (negative)
DELAY – delay time in DELAY characteristic	0 ÷ 700 ms

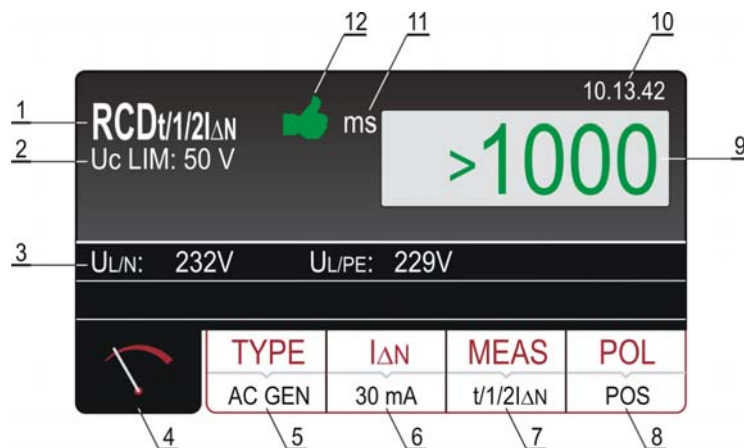

Figure 18: Display with RCD test result

- 1..... Selected function.
- 2..... Selected limit contact voltage (25 or 50 V). It can be selected in MENU→SETUP→CONTACT VOL. menu.
- 3..... Sub-results - mains voltages $U_{L/N}$ and $U_{L/PE}$ at which the test was carried out.
- 4..... Measurement screen touch-screen key.
- 5..... **TYPE** touch-screen key to select the type of RCD (AC, A or B) and characteristic (GENERAL, SELECTIVE or DELAYED). Currently selected type and characteristic are displayed on the bottom of the key.
- 6..... **$I_{\Delta N}$** touch-screen key to select nominal differential current of the RCD (10, 30, 100, 300, 500, 650 or 1000 mA). Currently selected value is displayed on the bottom of the key.
- 7..... **MEAS** touch-screen key to select the measurement ($t/1/2I_{\Delta N}$, $t/I_{\Delta N}$, $t/2I_{\Delta N}$, $t/5I_{\Delta N}$, I_{Δ} or AUTO). Currently selected measurement is displayed on the bottom of the key.
- 8..... **POL** touch-screen key to select test current polarity (POS - positive or NEG - negative).
- 9..... Test result (in green colour - result OK, in red colour - result not OK).
- 10... Real time clock (hh.mm.ss).
- 11... Unit of the test result (ms).
- 12... Measurement result status (symbol in green colour - result OK, symbol in red colour - result not OK).

5.5.2. EXPLANATION OF RCD TEST CURRENTS

See the figures below for test current shapes with regard to selected RCD type and test current polarity.

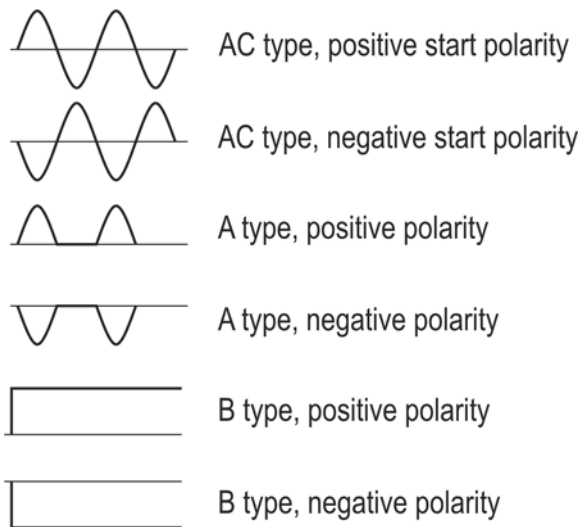

Figure 19: Test current shapes with regard to selected RCD type and test current polarity in trip time measurement

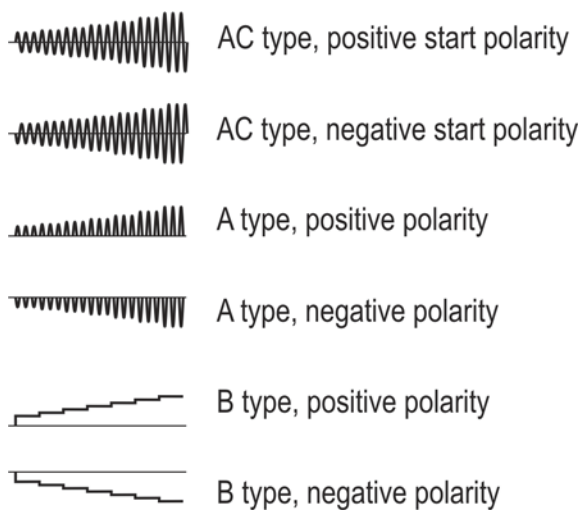

Figure 20: Test current shapes with regard to selected RCD type and test current polarity in RAMP test

5.5.3. RCD MEASUREMENT

Measured quantities and display ranges:

Trip out time at $I_{\Delta N}/2$	0 ÷ 1000 ms (AC, A, B, general, selective, delayed)
Trip out time at $I_{\Delta N}$	0 ÷ 1000 ms (AC, A, B, general, selective, delayed)
Trip out time at $2I_{\Delta N}$	0 ÷ 200 ms (AC, A, general), 0 ÷ 250 ms (AC, A, selective)
Trip out time at $4I_{\Delta N}$	0 ÷ 200 ms (B, general), 0 ÷ 250 ms (B, selective)
Trip out time at $5I_{\Delta N}$	0 ÷ 50 ms (AC, A, general), 0 ÷ 150 ms (AC, A, selective)
AUTO test	YES (general, selective)
Trip out current (Ramp test)	10 ÷ 110% of $I_{\Delta N}$ in steps of 5% of $I_{\Delta N}$ (general)

Input requirements:

Mains voltage $U_{L/N}$ (READY condition)	100 ÷ 265 V AC
Mains voltage $U_{L/PE}$ (READY condition)	100 ÷ 265 V AC

- 1) Select the RCD function by pressing the **FUNC** hard key first.
- 2) Check selected RCD type (AC, A or B) and selected characteristic (GENERAL, SELECTIVE or DELAYED) and modify it if needed by pressing the **TYPE** (5) touch-screen key first. If DELAYED characteristic is selected, the screen will turn to delay time adjustment mode automatically.
- 3) Select nominal differential current by pressing the **$I_{\Delta N}$** touch-screen key first.
- 4) Select wished measurement by pressing the **MEAS** touch-screen key first ($t_{I/2I_{\Delta N}}$, $t_{I_{\Delta N}}$, $t_{2I_{\Delta N}}$, $t_{5I_{\Delta N}}$, $I_{\Delta N}$ or AUTO).
- 5) Check selected polarity and modify it if needed by pressing the **POL** (8) touch-screen key first.
- 6) Select measurement screen by pressing the  (4) touch-screen key and check all settings again.
- 7) Connect the test leads according to one of the figures below.

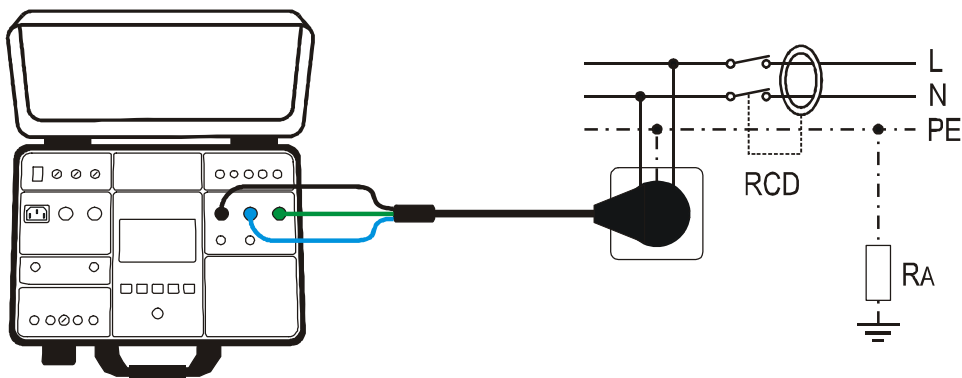

Figure 21: Connection of schuko test cable

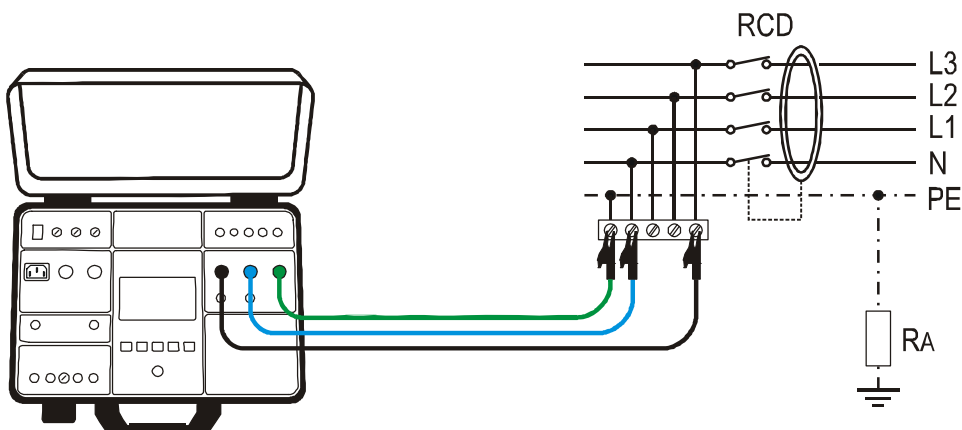

Figure 22: Connection of test leads

READY message will appear as soon as the tester is properly connected to the installation and mains voltage is present, see the "Input conditions" above.

- 8) Carry out the measurement by pressing the **START** button.
- 9) Test result will be displayed in green colour equipped with green symbol and with beep-beep sound if it is within limit range, see the table of allowed trip out times below. If the result is out of limit range, then it will be displayed in red colour equipped with red symbol and with longer beep sound. See the display outlook with test result on the figure 17.
- 10) Save the test result by pressing the **SAVE** hard key twice, for further instructions see the "MEMORIZING EXAMPLE" section.
- 11) Press the **EXIT** hard key to clear displayed result, actual input voltages UL/N and UL/PE will start to be displayed again.

Allowed trip out times:

Characteristic / I Δ	I Δ N/2	I Δ N	2I Δ N	(4) 5I Δ N
GENERAL	>1000 ms	≤ 300 ms	≤ 150 ms	≤ 40 ms
SELECTIVE	>1000 ms	130 ÷ 500 ms	60 ÷ 200 ms	50 ÷ 150 ms
DELAYED	>1000 ms	D ÷ (D + 300) ms	-	-

D ... Delay time which can be set to 0 ÷ 700 ms

CAUTION



- When selecting RCD type (TYPE), nominal differential current (I Δ N) or measurement (MEAS) it may happen that wished parameter will not be available (displayed in watery colour). In this case the level of other parameter or even other two parameters shall be reduced first.
- In case both voltages UL/N and UL/PE within required range 100 ÷ 265 V are present at L/N/PE test terminals (also displayed) but there is no READY message displayed, check if energizing socket is correctly earthed!

The following specific information can be shown on the display during the measurement:

Information displayed	Description
VOLTAGE OUT OF RANGE	Input voltage UL/N or UL/PE out of required range 100 ÷ 265 V after pressing the START key.
MEASUREMENT FAILED!	Input voltage failed during the measurement (disconnection of test leads, installation fuse tripped etc.)
CONTACT VOLTAGE!	Contact voltage higher than set limit value (25 V or 50 V)
EXTERNAL IMPEDANCE TOO HIGH!	Impedance in L conductor is too high, preset current can not be generated.
FUSE F3!	Fuse F3 is blown.
HOT!	Internal circuitry is overheated. <i>Wait to cool it down!</i>

5.6. LOOP IMPEDANCE / SHORT-CIRCUIT CURRENT (LOOP)

- According to EN 60204-1, the conditions for protection against electric shock in installations with automatic disconnection of mains voltage are:
 - Measurement or evaluation of fault loop impedance and testing the over-current protection device involved in the fault loop.
 - Limit values are shown in the Table 10 of EN 60204-1.

5.6.1. LOOP DISPLAY EXPLANATION

Adjustable/selectable parameters:

MODE - measurement mode	LOOP L/N, LOOP L/L, LOOP L/PE, IMP57 L/N, IMP57 L/L or IMP57 L/PE
LIMIT - limit value mode	STD, kA, I ² t, TRIP CURR. or U _t , see the explanation below
I _b – breaking capacity of protection	1, 1.5, 3, 4.5, 6, 10, 15, 16, 20 or 25 kA
PROTECTION - type of protection	MCB B, MCB C, MCB D, MCB K, FUSE gG or FUSE aM
I _n - nominal current of protection	See the values in chapter “LIMIT VALUE EXPLANATION” below
T _{set} - max allowed tripping time	0.1 s, 0.2 s, 0.4 s or 5 s
WIRE - wire material	Cu (Copper) or Al (Aluminium)
COATING - wire coating	PVC, BUTYL RUBBER or EPR/XLPE
SECTION - wire section	1, 1.5, 2.5, 4, 6, 10, 16, 25, 35, 50, 70, 95, 120, 150, 185, 240, 300, 400, 500 or 630 mm ²
N - number of conductors	1 ÷ 99

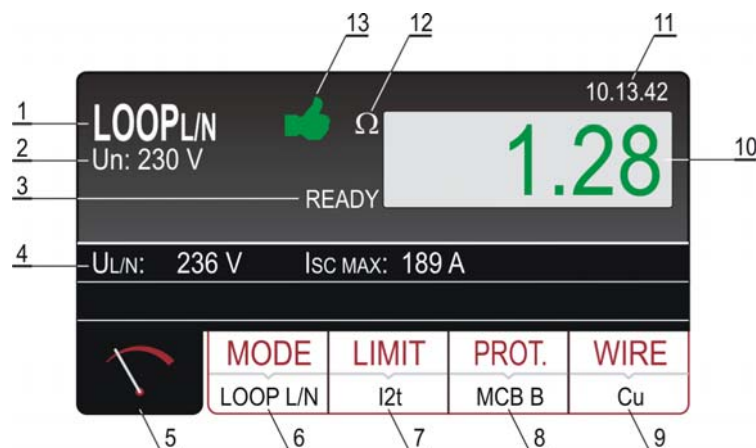

Figure 23: Display with LOOP L/N test result

- Selected function.
- Selected nominal voltage (230 or 240 V) needed for calculation of short-circuit current.
- READY message. It is displayed when present mains voltage UL/L, UL/N or UL/PE within required range is present.
- Sub-results - mains voltage UL/PE or UL/PE or UL/L at which the measurement has been done and calculated prospective short-circuit current ISC.
- Measurement screen touch-screen key.
- **MODE** touch-screen key to select measurement mode (LOOP L/N, LOOP L/L, LOOP L/PE, IMP57 L/N, IMP57 L/L or IMP57 L/PE). Currently selected mode is displayed on the bottom of the key.
- **LIMIT** touch-screen key to select limit mode (STD, kA, I²t, TRIP CURR. or U_t). Currently selected mode is displayed on the bottom of the key.

- PROT (type of protection) MCB B, MCB C, MCB D, MCB K, FUSE gG or FUSE aM
- In (nominal current) - 6, 10, 13, 16, 20, 25, 32, 40, 50 or 63 A (MCB B)
- 0.5, 1, 1.6, 2, 4, 6, 10, 13, 16, 20, 25, 32, 40, 50 or 63 A (MCB C)
- 0.5, 1, 1.6, 2, 4, 6, 10, 13, 16, 20, 25 or 32 A (MCB D, MCB K)
- 2, 4, 6, 8, 10, 12, 16, 20, 25, 32, 40, 50, 63, 80, 100, 125, 160,
- 200, 250, 315, 400, 500, 630, 800, 1000 or 1250 A (FUSE gG)
- 2, 4, 6, 8, 10, 12, 16, 20, 25, 32, 40, 50, 63, 80, 100, 125, 160,
- 200, 250, 315, 400, 500 or 630 A (FUSE aM)
- Tset (max trip time) 0.1, 0.2, 0.4 or 5 s

Ut - verification if short-circuit current is high enough over-current protection device to react within set time.

On bases of entered over-current protection device (PROTECTION), nominal current of the over-current protection device (In) and Tset required short-circuit current (Ia) is calculated. Measured ISC MIN must be higher than or equal to calculated current Ia. Entered parameters can be selected among the following values:

- PROT (type of protection) MCB B, MCB C, MCB D, MCB K, FUSE gG or FUSE aM
- In (nominal current) - 6, 10, 13, 16, 20, 25, 32, 40, 50 or 63 A (MCB B)
- 0.5, 1, 1.6, 2, 4, 6, 10, 13, 16, 20, 25, 32, 40, 50 or 63 A (MCB C)
- 0.5, 1, 1.6, 2, 4, 6, 10, 13, 16, 20, 25 or 32 A (MCB D, MCB K)
- 2, 4, 6, 8, 10, 12, 16, 20, 25, 32, 40, 50, 63, 80, 100, 125, 160,
- 200, 250, 315, 400, 500, 630, 800, 1000 or 1250 A (FUSE gG)
- 2, 4, 6, 8, 10, 12, 16, 20, 25, 32, 40, 50, 63, 80, 100, 125, 160,
- 200, 250, 315, 400, 500 or 630 A (FUSE aM)
- Tset (max trip time) 0.1, 0.2, 0.4, or 5 s

5.6.3. PROSPECTIVE SHORT-CIRCUIT CURRENT CALCULATION

Evaluation table and short-circuit current calculation:

	LIMIT mode	TT – Evaluation condition	TN – Evaluation condition
L/L	STD	No evaluation	No evaluation
	kA	ISC L/L MAX 3PH < BC	ISC L/L MAX 3PH < BC
	I ² t	$(ISC\ L/L\ MAX\ 3PH)^2 \times t < (K \times N \times S)^2$	$(ISC\ L/L\ MAX\ 3PH)^2 \times t < (K \times N \times S)^2$
	TRIP CURR.	ISC L/L MIN 2PH → Tmax, Tmax < Tlim	ISC MIN 2PH → Trip time T, T < Tlim
	Ut		
L/N	STD	No evaluation	No evaluation
	kA	ISC L/L MAX 3PH < BC	ISC L/L MAX 3PH < BC
	I ² t	$(ISC\ L/N\ MAX)^2 \times t < (K \times N \times S)^2$	$(ISC\ L/N\ MAX)^2 \times t < (K \times N \times S)^2$
	TRIP CURR.	ISC MIN 2PH → Trip time T, T < Tlim	ISC MIN 2PH → Trip time T, T < Tlim
	Ut		
L/N	STD	No evaluation	No evaluation
	kA	ISC MAX L/N < Breaking capacity IB	ISC MAX L/N < Breaking capacity IB
	I ² t	$(ISC\ MAX\ L/N)^2 \times T < (K \times N \times S)^2$	$(ISC\ MAX\ L/N)^2 \times T < (K \times N \times S)^2$
	TRIP CURR.	ISC MIN L/N → Trip time T, T < Tlim	ISC MIN L/N → Trip time T, T < Tlim
L/PE	STD	No evaluation	No evaluation
	kA	ISC MAX L/PE < Breaking capacity IB	ISC MAX L/PE < Breaking capacity IB
	I ² t	$(ISC\ MAX\ L/PE)^2 \times T < (K \times N \times S)^2$	$(ISC\ MAX\ L/PE)^2 \times T < (K \times N \times S)^2$

	TRIP CURR.	ISC MIN L/PE → Trip time T, T < T _{lim}	ISC MIN L/PE → Trip time T, T < T _{lim}
	U _t	ISC MIN L/PE > N × I _n	ISC MIN L/PE > N × I _n

Where:

T ... Trip out time according to the characteristic and nominal current of used protection device

K ... See the table below

Material / Coating	PVC	Natural / Butyl rubber	EPR/XLPE
Cu (Copper)	K = 115	K = 135	K = 143
Al (Aluminium)	K = 76	K = 87	K = 94

N ... Number of conductors

S ... Cross section of a conductor

For calculation of short-circuit current ISC nominal voltage U_n of mains installation is needed, so it must be selected in prior to the measurements.

How to select the nominal voltage U_n:

Press the **MENU** → **SETUP** → **NOMINAL VOL.** touch-screen keys and select 230 V or 240 V. See the chapter “6.5.5. NOMINAL VOLTAGE menu”.

5.6.4. LOOP MEASUREMENT

Measured quantities and display ranges:

Loop impedance LOOPL/L	0 ÷ 200 Ω
Loop impedance LOOPL/N	0 ÷ 200 Ω
Loop impedance LOOPL/PE	0 ÷ 200 Ω
Loop impedance LOOPL/L (IMP57)	0 ÷ 2 Ω
Loop impedance LOOPL/N (IMP57)	0 ÷ 2 Ω
Loop impedance LOOPL/PE (IMP57)	0 ÷ 2 Ω
Mains voltage U _{L/L}	173 ÷ 460 V
Mains voltage U _{L/N} or U _{L/PE}	100 ÷ 265 V
Short circuit current ISC	0.05 ÷ 46.00 kA

Input requirements:

Mains voltage U _{L/L} (READY condition)	100 ÷ 460 V AC
Mains voltage U _{L/N} or U _{L/PE} (READY condition)	100 ÷ 265 V AC

- 1) Select LOOP measurement by pressing the **FUNC** hard key first.
- 2) Check selected measurement mode (LOOP L/N, LOOP L/L, LOOP L/PE, IMP57 L/N, IMP57 L/L or IMP57 L/PE) and modify it if needed by pressing the **MODE** (5) touch-screen key first.
- 3) Check selected limit mode (STD, kA, I²t, TRIP CURR. or U_t) and modify it if needed after pressing the **LIMIT** (6) touch-screen key.
- 4) Check other parameters (they depend on selected limit mode) like type of protection, nominal current, wire material etc. and modify them if needed by pressing appropriate parameter touch-screen key first.
- 5) Select measurement screen by pressing the  (4) touch-screen key and check all settings again.
- 6) Connect the test leads according to one of the figures below.

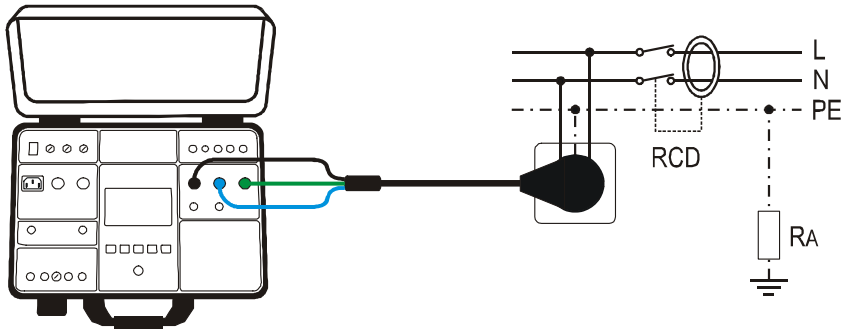

Figure 24: Connection of test cable to schuko socket for LOOPL/N or LOOPL/PE measurement

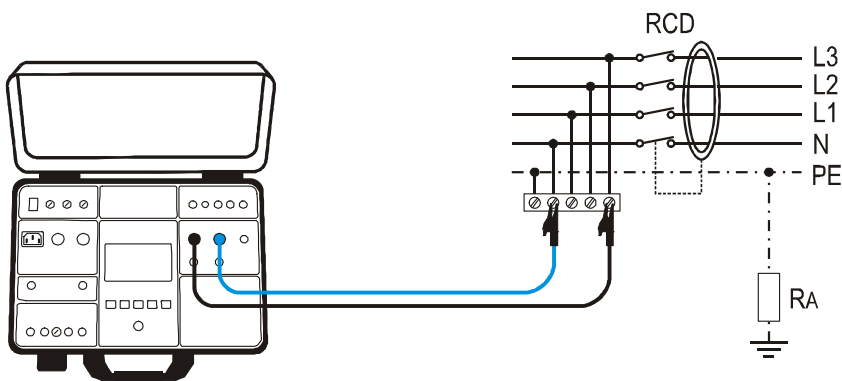

Figure 25: Connection of test leads to tested wiring for LOOPL/N measurement

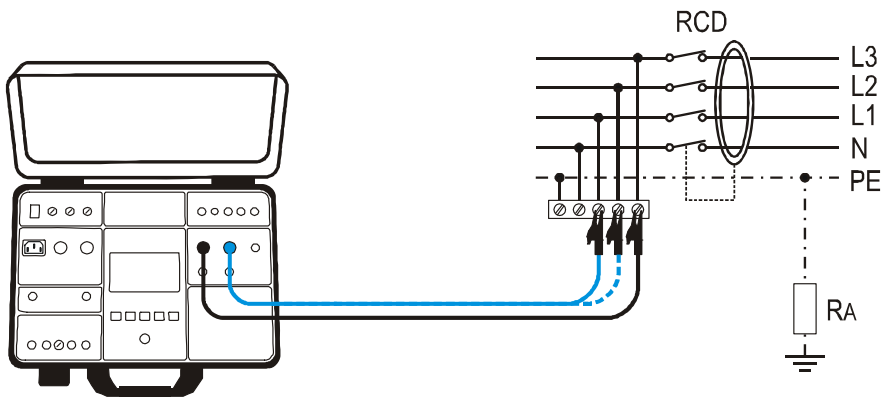

Figure 26: Connection of test leads to tested wiring for LOOPL/L measurement

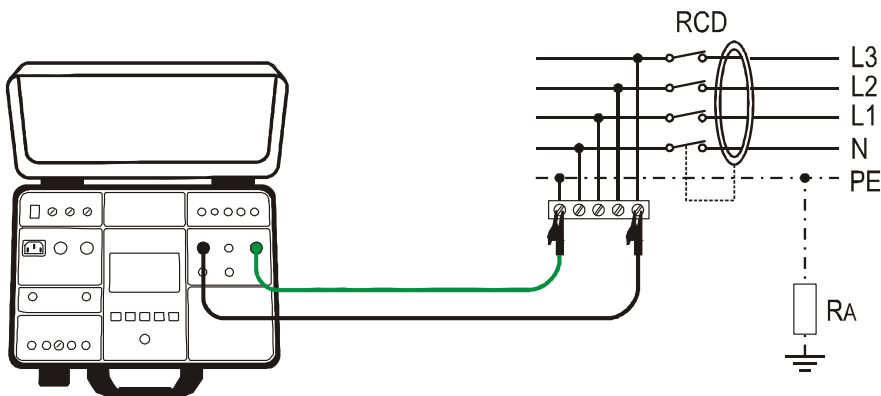

Figure 27: Connection of test leads to tested wiring for LOOPL/PE measurement

- 7) READY message will appear when mains voltage $U_{L/N}$ (LOOP L/N) or $U_{L/PE}$ (LOOP L/PE) within $100 \div 265$ V or $U_{L/L}$ (LOOP L/L) within $100 \div 460$ V is present. Carry out the measurement by pressing the **START** button.
- 8) Test result (loop impedance) will be displayed in green colour equipped with green symbol and with beep-beep sound if measured/calculated ISC corresponds to entered limit mode and other entered parameters. If measured/calculated ISC does not correspond to entered limit mode and other entered parameters the result will be displayed in red colour equipped with red symbol and with longer beep sound. See the display outlook with test result on the figure 22.
- 9) Save the test result by pressing the **SAVE** hard button twice, for further instructions see the "MEMORIZING EXAMPLE" section.
- 10) Press the **EXIT** hard key to clear displayed result, actual input voltage $U_{L/L}$ or $U_{L/N}$ or $U_{L/PE}$ will start to be displayed again.

CAUTION



- In case voltage $U_{L/N}$ (LOOP L/N measurement) or voltage $U_{L/PE}$ (LOOP L/PE measurement) within required range $100 \div 265$ V is present at L/N/PE test terminals (also displayed) but there is no READY message displayed, check if energizing socket is correctly earthed!
- In case voltage $U_{L/L}$ (LOOP L/L measurement) within required range $100 \div 460$ V is present at L/N test terminals (also displayed) but there is no READY message displayed, check if energizing socket is correctly earthed!
- If limit mode STD is selected (result is not evaluated), then the result will be displayed in white colour.

The following specific information can be shown on the display during the measurement:

Information displayed	Description
VOLTAGE OUT OF RANGE	Input voltage $U_{L/N}$ or $U_{L/PE}$ out of required range $100 \div 265$ V (L/N or L/PE measurement) or out of required range $173 \div 460$ V (L/L measurement) after pressing the START key.
FUSE F3!	Fuse F3 is blown.
HOT!	Internal load is overheated. <i>Wait to cool it down!</i>
MEASUREMENT FAILED!	Input voltage failed during the measurement (disconnection of test leads, installation fuse tripped etc.)

5.7. GLOBAL EARTH RESISTANCE / CONTACT VOLTAGE (RA)

- According to EN 60204-1, the conditions for protection against electric shock in installations with automatic disconnection of mains voltage are:
 - Measurement or evaluation of fault loop impedance and testing the over-current protection device involved in the fault loop.
 - Limit values are shown in the Table 10 of EN 60204-1.

5.7.1. RA LIMIT VALUE CALCULATION

The global resistance R_A should be lower than or equal to $U_{C\ LIM} / I_{\Delta N}$, where limit contact voltage U_C can be set to 25 or 50 V.

Example: Selected $U_{C\ LIM} = 50\text{ V}$
 Selected $I_{\Delta N} = 300\text{ mA}$

 $R_{A\ LIM} = 166.7\ \Omega$

How to select limit contact voltage $U_{C\ LIM}$:

Press the **MENU** → **SETUP** → **CONTACT VOL.** touch-screen keys and select 25 V or 50 V.

5.7.2. RA DISPLAY EXPLANATION

Selectable parameter:

$I_{\Delta N}$ nominal differential current 10, 30, 100, 300, 500, 650 or 1000 mA

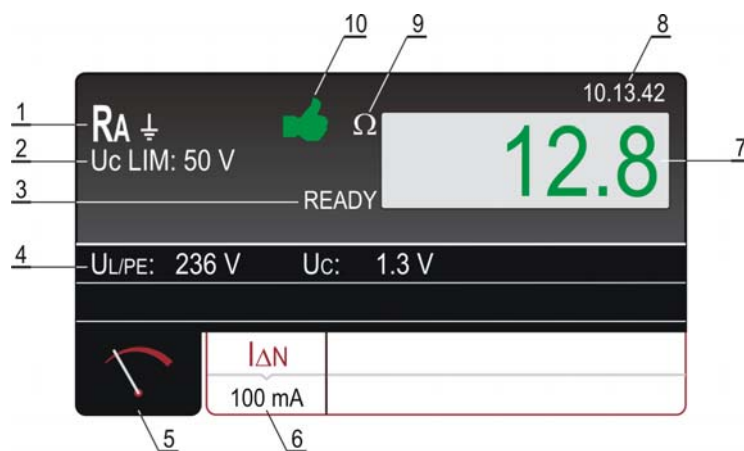



Figure 28: Display with RA test result

- 1..... Selected function.
- 2..... Selected limit contact voltage (25 or 50 V).
- 3..... READY message. It is displayed when mains voltage $U_{L/PE}$ within 100 ... 265 V is present.
- 4..... Sub-results, mains voltage $U_{L/PE}$ at which the measurement was carried out and contact voltage U_C at nominal differential current.
- 5..... Measurement screen touch-screen key.
- 6..... $I_{\Delta N}$ touch-screen key to select nominal differential current. Currently selected value is displayed in the bottom of the key.
- 7..... Measurement result (in green colour - result OK, in red colour - result not OK).
- 8..... Real time clock (hh.mm.ss).
- 9..... Unit of the test result.
- 10... Measurement result status (symbol  in green colour - result OK, symbol  in red colour - result not OK).

5.7.3. RA MEASUREMENT

Measured quantities and display ranges:

Global earth resistance RA	0 ÷ 2.000 Ω (I Δ N = 10 or 30 mA)
	0 ÷ 1.000 Ω (I Δ N = 100 mA)
	0 ÷ 300 Ω (I Δ N = 300 mA)
	0 ÷ 200 Ω (I Δ N = 500 mA)
	0 ÷ 150 Ω (I Δ N = 650 mA)
	0 ÷ 100 Ω (I Δ N = 1000 mA)
Mains voltage U _{L/PE}	100 ÷ 265 V AC
Contact voltage U _C	0 ÷ 100 V AC (U _{C LIM} = 50 V)
	0 ÷ 50 V AC (U _{C LIM} = 25 V)

Input requirements:

Mains voltage U_{L/PE} (READY condition) 100 ÷ 265 V AC

- 1) Select the RA measurement by pressing the **FUNC** hard key first.
- 2) Check selected nominal differential current (10, 30, 100, 300, 500, 650 and 1000 mA) and modify it if needed by pressing the I Δ N (6) touch-screen key first.
- 3) Select measurement screen by pressing the (5) touch-screen key and check all settings again.
- 4) Connect the test leads according to one of the figures below. READY message (3) will appear when mains voltage U_{L/PE} within 100 ... 265 V is present.

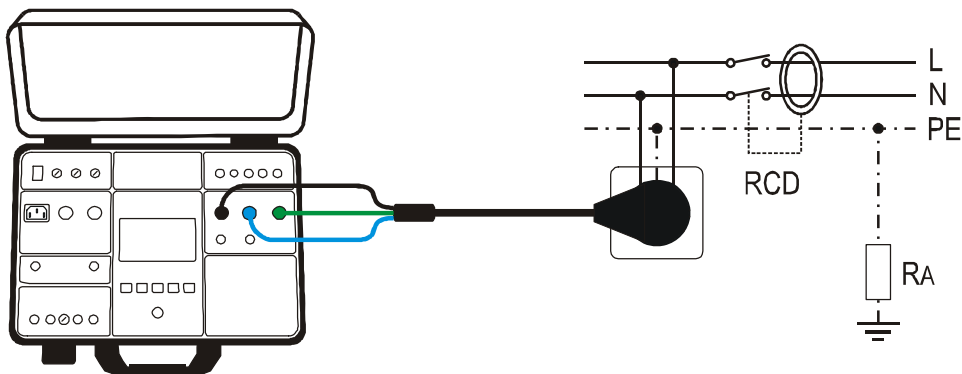

Figure 29: Connection of test cable to schuko socket

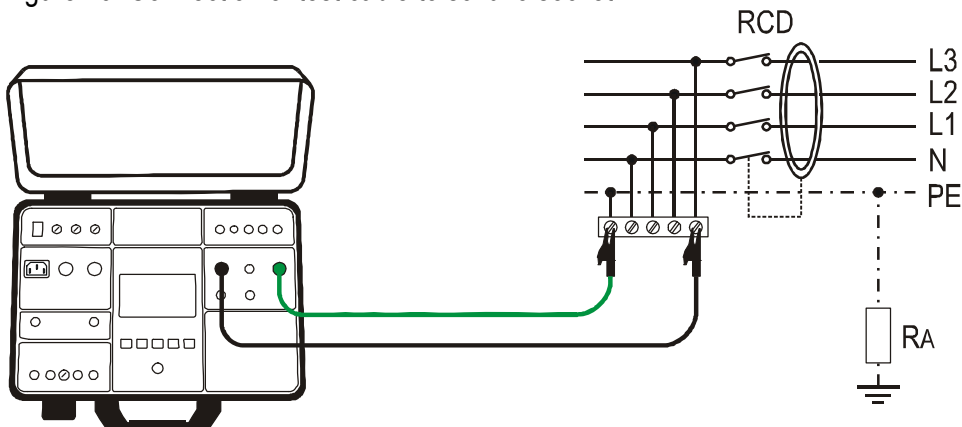

Figure 30: Connection of test leads to tested wiring

- 5) Carry out the measurement by pressing the **START/STOP** button. Test result will be displayed after elapsing measurement time in green colour equipped with green symbol and with beep-beep sound if it is lower than or equal to limit value (see the explanation of limit value above). If the result is higher than limit value, then it will be displayed in red colour equipped with red symbol and with longer beep sound. See the display outlook with test result on the figure 27.
- 6) Save the test result by pressing the **SAVE** hard key twice, for further instructions see the "MEMORIZING EXAMPLE" section.
- 7) Press the EXIT hard key to clear displayed result, actual input voltage UL/PE will start to be displayed again.

CAUTION



- In case voltage UL/PE within required range 100 ÷ 265 V is present between L and PE test terminals (also displayed) but there is no READY message displayed, check if energizing socket is correctly earthed!

The following specific information can be shown on the display during the measurement:

Information displayed	Description
VOLTAGE OUT OF RANGE!	Input voltage UL/PE out of required range 100 ÷ 265 V after pressing the START key.
CONTACT VOLTAGE > 50 V or CONTACT VOLTAGE > 25 V	Contact voltage higher than selected limit value, probably due to too high loop resistance.
MEASUREMENT FAILED!	Measurement current was interrupted either due to disconnection of test leads or due to increase of loop resistance.
FUSE F3!	Fuse F3 is blown.
HOT!	Internal circuitry is overheated. <i>Wait to cool it down!</i>

5.8. RESIDUAL VOLTAGE (URES)

- What are residual voltages? Residual voltages are the voltages that remain present even after switching off a machine or device. This can be caused e.g. by built in capacitors or subsequent generators. This measurement is performed by using the URES function.
- According to EN 60204-1, accessible live parts connected to dangerous voltage must discharge within 5 seconds (permanently connected machines) or within 1 second (plugged-in machines) down to 60 V. Proof of this must be given through tests.
- In the event of non-compliance, additional measures (discharge devices, warning information, covers etc.) according to EN 60204-1 must be taken.
- With FULLTEST 3 tester the residual voltage can be measured 1 s or 5 s after switching off tested machine. Measurement of residual voltage can be carried out in linear or non-linear mode, see the section "EXPLANATION OF LINEAR MODE" or section "EXPLANATION OF NONLINEAR MODE".

5.8.1 EXPLANATION OF LINEAR MODE

In linear mode it is assumed there are only "linear" components involved in discharging process (capacitors, resistors, inductors etc.) and therefore discharge characteristic is exponential, see the diagram below.

In linear mode displayed result is scaled to peak value of input voltage in order to evaluate most critical situation, see the figure below.

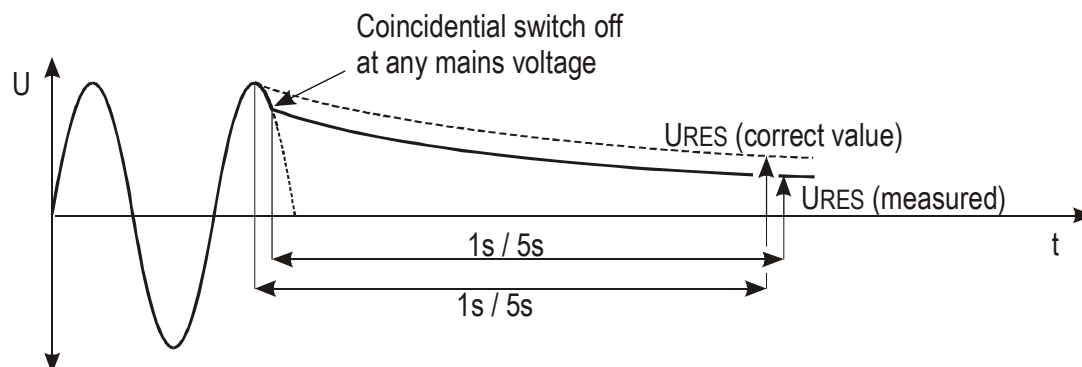

Figure 31: Discharge diagram in linear circumstances

For scaling of measured URES voltage U_n of mains installation is needed, so it must be selected in prior to the measurements.

How to select the nominal voltage U_n :

Press the **MENU** → **SETUP** → **NOMINAL VOL.** touch-screen keys and select 230 V or 240 V. See the chapter "6.5.5. NOMINAL VOLTAGE menu".

In linear mode the FULLTEST 3 detects automatically two standard system voltages:

- a) Selected nominal voltage $U_n = 230$ V
- 230 V $U_{IN} = 230$ V \pm 10%
- 400 V $U_{IN} = 400$ V \pm 10%

- b) Selected nominal voltage $U_n = 240$ V:
- 240 V $U_{IN} = 240$ V \pm 10%
- 415 V $U_{IN} = 415$ V \pm 10%

To include standard mains over-voltage, the measured residual voltage is scaled to peak value of max. possible mains over-voltage, i.e.:

- a) Selected nominal voltage $U_n = 230\text{ V}$
 $U_p = 230\text{ V} \times 1.1 \times 1.41 = 358\text{ V}$ system voltage 230 V is recognized
 $U_p = 400\text{ V} \times 1.1 \times 1.41 = 620\text{ V}$ system voltage 400 V is recognized
- b) Selected nominal voltage $U_n = 240\text{ V}$
 $U_p = 240\text{ V} \times 1.1 \times 1.41 = 372\text{ V}$ system voltage 240 V is recognized
 $U_p = 415\text{ V} \times 1.1 \times 1.41 = 644\text{ V}$ system voltage 415 V is recognized

If actual mains voltage differs from nominal system voltage more than $\pm 10\%$, the FULLTEST 3 scales the result to peak value of actual input voltage.

Example 1 ($U_n = 230\text{ V}$):
 $U_{IN} = 173\text{ V}$ (the value differs more than 10% from 230 V), result is scaled to $173\text{ V} \times 1.41 = 244\text{ V}$

Example 2 ($U_n = 230\text{ V}$):
 $U_{IN} = 209\text{ V}$ (the value differs less than 10% from 230 V), result is scaled to $230\text{ V} \times 1.1 \times 1.41 = 358\text{ V}$

5.8.2. EXPLANATION OF NONLINEAR MODE

In non-linear mode it is assumed there are also "non-linear" or unknown components involved in discharge process (relays, gas lamps etc.) and therefore discharge characteristic is non-exponential or it is unpredictable, see the diagram below.

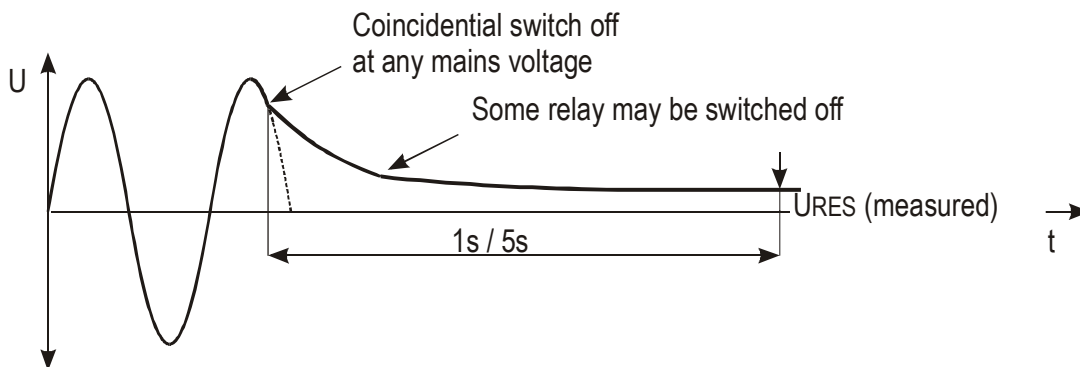

Figure 32: Discharge diagram in non-linear circumstances

In this case result can not be scaled to peak value, so it must be assured that switch off occurs at max. input voltage i.e. at pick value ($\pm 5\%$), otherwise measured result is not relevant. Measured value is then registered and evaluated.

5.8.3. URES DISPLAY EXPLANATION

Selectable parameters:

MODE - measurement mode	LINEAR or NONLINEAR
CON - connection	INT (measurement on internal components) or PLUG (measurement on 1P/3P plug)
LIMIT t - limit time	1 s or 5 s

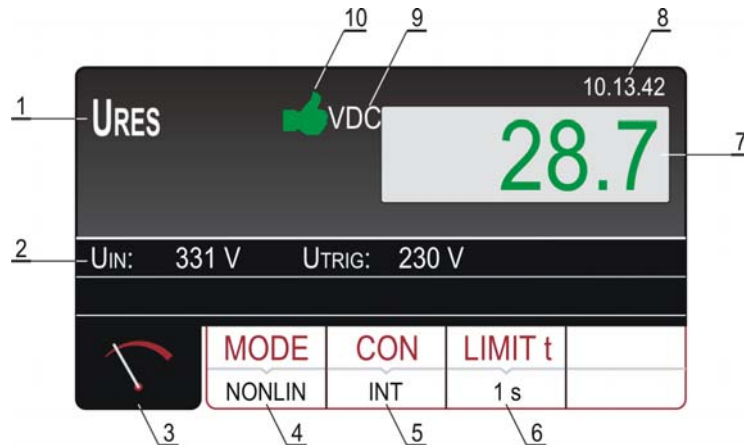

Figure 33: Display with URES test result

- 1..... Selected function.
- 2..... Input voltage U_{IN} and trigger voltage U_{TRIG} .
- 3..... Measurement screen touch-screen key.
- 4..... **MODE** touch-screen key to select measurement mode (LINEAR or NONLINEAR). Currently selected mode is displayed on the bottom of the key.
- 5..... **CON** (connection) touch-screen key to select measurement connection (INT or PLUG). Currently selected connection is displayed on the bottom of the key.
- 6..... **LIMIT t** touch-screen key to select limit time (1 s or 5 s), valid for internal measurement only. Currently selected limit value is displayed on the bottom of the key.
- 7..... Measurement result (in green colour - result OK, in red colour - result not OK).
- 8..... Real time clock (hh.mm.ss).
- 9..... Unit of the test result. As measured URES voltage may be alternating or direct there is an appropriate information AC or DC added to the unit.
- 10... Measurement result status (symbol in green colour - result OK, symbol in red colour - result not OK).

5.8.4. TRIGGER CONDITIONS

The instrument recognizes disconnection of mains voltage on TRIG input (INT measurement) or on URES input (PLUG measurement) when one of the following two conditions occurs:

- If mean value of rectified input voltage drops down with a slope of at least 25 V / s (mean value measured each period), then trigger is activated and the measurement starts to run. This condition will occur for example if AC or DC input voltage starts to decrease.
- Momentary value of current half period is compared with momentary value of previous half period (the same polarity). If there is a difference higher than 10%, then trigger is activated and the measurement starts to run. This condition will occur for example if AC voltage changes to DC.

The above two conditions are active on URES input in PLUG mode and on UTRIG input in INT mode.

5.8.5. URES MEASUREMENT

Measured quantities and display ranges:

Residual voltage on power plug URES $10 \div 460$ V AC or $10 \div 650$ V DC

Residual voltage on internal components URES $10 \div 460$ V AC or $10 \div 650$ V DC

Input requirements:

Input voltage U_{IN} (READY condition in PLUG mode) $43 \div 460$ V

Trigger voltage U_{TRIG} (READY condition in INT mode) $100 \div 460$ V AC

- 1) Select URES function by pressing the **FUNC** key first.
- 2) Check selected mode and modify it if needed by pressing the **MODE** (4) touch-screen key first.
- 3) Check selected connection and modify it if needed by pressing the **CON** (5) touch-screen key first.

INT 4-WIRE mode is selected:

- 4) Check selected limit time and modify it if needed by pressing the **LIMIT t** (6) touch-screen key first.
- 5) Select measurement screen by pressing the  (3) touch-screen key and check all settings again.
- 6) Connect test leads according to one of the figures below.

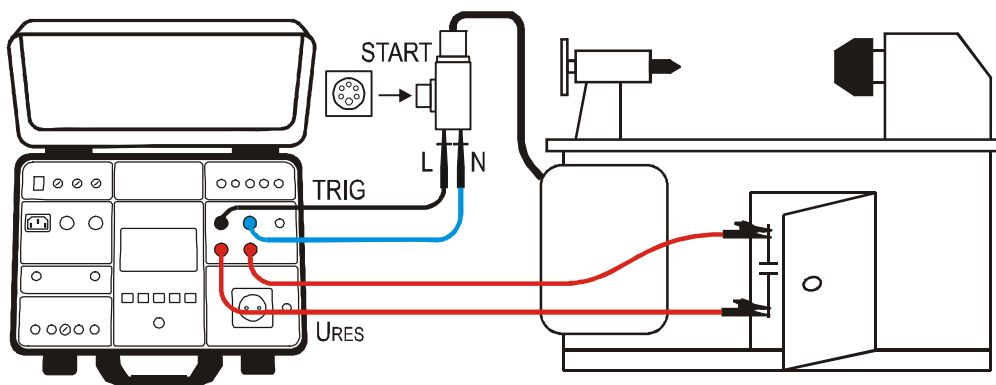

Figure 34: Connection of test leads in URES INT measurement on 1P/3P plugged machines

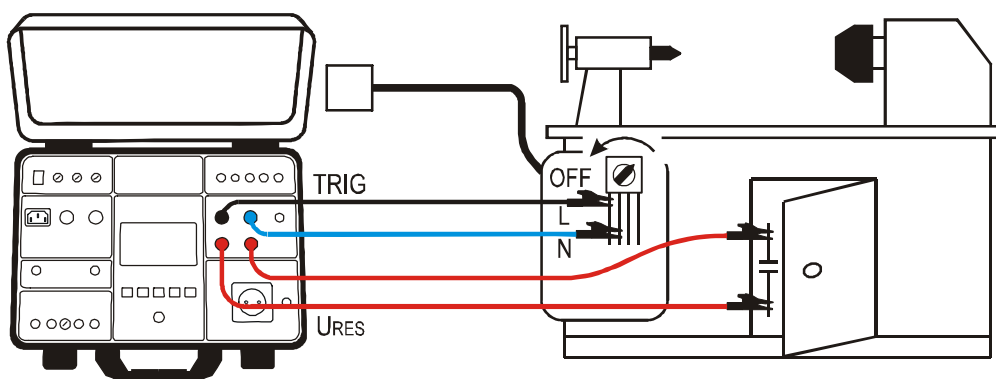

Figure 35: Connection of test leads in URES INT measurement on fixed connected machines

- 7) READY, DISCONNECT UUT message will appear when U_{TRIG} voltage within required range $100 \div 460$ V AC is present. Carry out the measurement by disconnecting UUT. Disconnection of UUT according to the figure 33 means disconnection of multiple plug adapter. Disconnection of UUT according to the figure 34 means turning off mains switch.

- 8) Test result will be displayed in green colour equipped with green symbol and with beep-beep sound if it is lower than or equal to 60 VRMS (may be AC or DC, see the unit). If the result is higher than 60 VRMS, then it will be displayed in red colour equipped with red symbol and with longer beep sound. See the display outlook with test result on the figure 32.
- 9) Save the test result by pressing the **SAVE** hard key twice, for further instructions see the “MEMORIZING EXAMPLE” section.
- 10) Press the EXIT hard key to clear displayed result, actual input voltage UIN and actual trigger voltage UTRIG will start to be displayed again.

PLUG/1s mode is selected:

- 4) Select measurement screen by pressing the (3) touch-screen key and check all settings again.
- 5) Connect test leads according to the figure below.

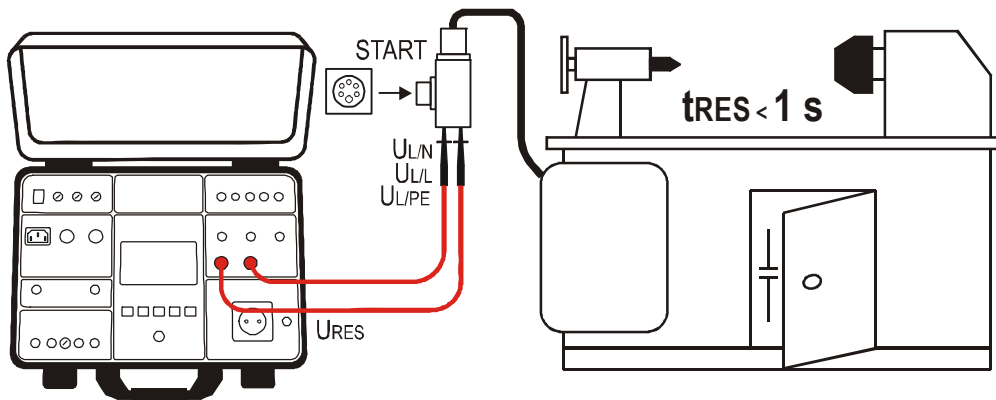

Figure 36: Connection of test leads in URES PLUG measurement



- 6) READY, DISCONNECT UUT message will appear when input voltage UIN within required range $100 \div 460$ V AC is present. Carry out the measurement by disconnecting UUT. Disconnection of UUT according to the figure 35 means disconnection of multiple plug adapter.
- 7) Test result will be displayed in green colour equipped with green symbol and with beep-beep sound if it is lower than or equal to 60 VRMS (may be AC or DC, see the unit). If the result is higher than 60 VRMS, then it will be displayed in red colour equipped with red symbol and with longer beep sound. See the display outlook with test result on the figure 32.
- 8) Save the test result by pressing the **SAVE** hard key twice, for further instructions see the “MEMORIZING EXAMPLE” section.
- 9) Press the EXIT hard key to clear displayed result, actual input voltage UIN will start to be displayed again.

CAUTION



- Do not use the **START** button in this function, it has no function!

The following specific information can be shown on the display during the measurement:

Information displayed	Description
 <p>LOW TRIGGER VOLTAGE REPEAT</p>	<p>Mains voltage was disconnected at too low momentary voltage (< 20% of peak value). The message may appear in LINEAR mode only. <i>Repeat the measurement (connect and disconnect the UUT again)!</i></p>
 <p>LOW SWITCH-OFF VOLTAGE REPEAT</p>	<p>Mains voltage was not disconnected close enough to peak value ($U_p \pm 5\%$) so the result would be irrelevant anyway. The message may appear in NONLINEAR mode only. <i>Repeat the measurement (connect and disconnect the UUT again)!</i></p>

5.9. POWER (POWER)

Measured appliance is supplied by mains voltage applied to schuko test socket. Switching the voltage on/off as well as selection of phase position is done by internal switch of the tester.

5.9.1 POWER DISPLAY EXPLANATION

Adjustable/selectable parameters:

TIMER - measurement time	00:05 ÷ 60:00, resolution 1 s
LIMIT - limit value of apparent power	6 VA ÷ 5.06 kVA
L POS - position of phase terminal on schuko socket	LEFT or RIGHT

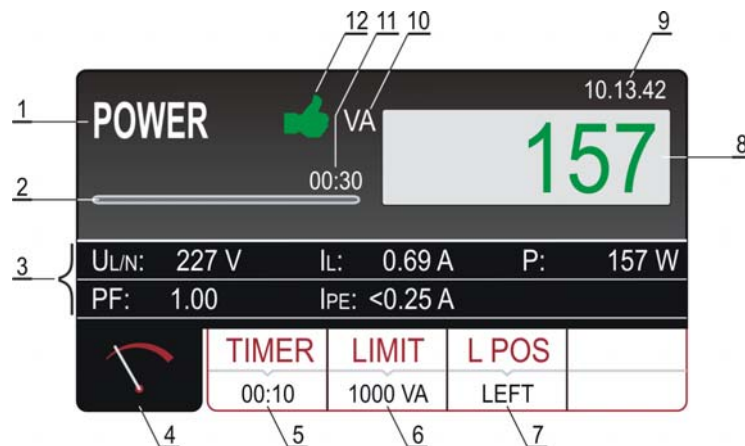



Figure 37: Display with POWER test result

- 1..... Selected function.
- 2..... Progress bar. It follows measurement time during the measurement.
- 3..... Two lines reserved for sub-results as follows: Mains voltages UL/N, Load current IL, Real power P, Power factor PF and Leakage current IPE.
- 4..... Measurement screen touch-screen key.
- 5..... **TIMER** touch-screen key to adjust measurement time. Currently selected measurement time is displayed on the bottom of the key.
- 6..... **LIMIT** touch-screen key to select limit apparent power. Currently selected value is displayed on the bottom of the key.
- 7..... **L POS** touch-screen key to select the position of phase terminal on schuko socket during the measurement. Currently selected position is displayed on the bottom of the key.
- 8..... Measurement result (in green colour - result OK, in red colour - result not OK).
- 9..... Real time clock (hh.mm.ss).
- 10... Unit of the test result.
- 11... Set measurement time.
- 12... Measurement result status (symbol in green colour - result OK, symbol in red colour - result not OK).

5.9.2. POWER MEASUREMENT

Measured quantities and display ranges:

Apparent power PAPP	0 ÷ 5.06 kVA
Real power P	0 ÷ 5.06 kW
Mains voltage UL/N	195 ÷ 253 V
Load current IL	0 ÷ 20 A
Power factor PF	0.00 ÷ 1.00
Leakage current IPE	0.25 mA ÷ 10 A

- 1) Select POWER function by pressing the **FUNC** hard key first.
- 2) Check selected measurement time and modify it if needed by pressing the **MODE** (5) touch-screen key first. Four independent preset measurement times are available for quicker operations. Select the closest one and modify it by using the **+** and **-** touch screen keys if needed.
- 3) Check selected limit apparent power and modify it if needed by pressing the **LIMIT** (6) touch-screen key first. Four independent preset limit values are available for quicker operations. Select the closest one and modify it by using the **+** and **-** touch screen keys if needed.
- 4) Check selected position of phase terminal on schuko socket by pressing the **L POS** (7) touch-screen key. If LEFT position is selected then phase potential is connected to the left terminal of schuko socket and vice versa.
- 5) Select measurement screen by pressing the  (4) touch-screen key and check all settings again.
- 6) Connect the UUT to schuko socket according to the figure below.

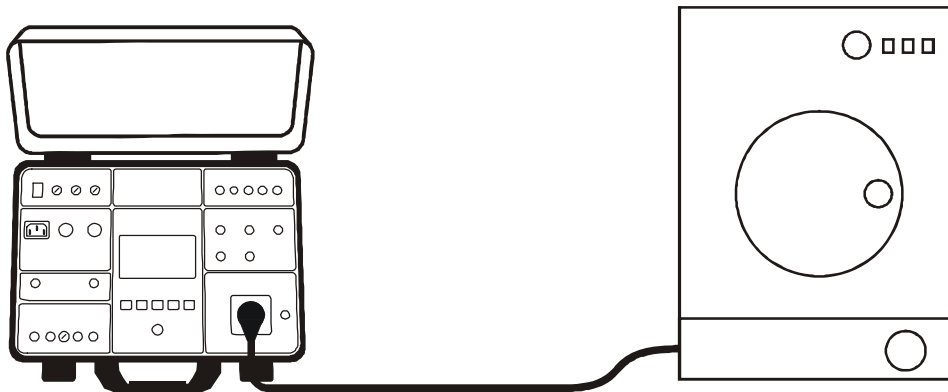



Figure 38: Connection of UUT to schuko test socket

7. Start the measurement by pressing the **START/STOP** button. The measurement will start to run and will be stopped after pressing the **START/STOP** button again or after elapsing set measurement time.
 Test result (apparent power) will be currently displayed in green colour if it is lower than or equal to set limit value or in red colour if it is higher than set limit value. Final result will be equipped with green  symbol and with beep-beep sound if it is OK or with red  symbol and with longer beep sound if it is not OK. See the display outlook with test result on the figure 36.
- 8) Save the test result by pressing the **SAVE** hard key twice, for further instructions see the "MEMORIZING EXAMPLE" section.

CAUTION

- Measurement at both phase positions (phase at left terminal and phase at right terminal) must be carried out when leakage current IPE is measured and the highest value must be evaluated.
- Switch on the UUT in order full power of the unit and total leakage current to be measured!
- In case of overloaded test socket the fuse F1 or F2 (both T16A/250V) may blow.
- Do not use test schuko socket except for measurement purpose!

The following specific information can be shown on the display during the measurement:

Information displayed	Description
IPE > 3.5 mA	Leakage current IPE is higher than 3.5 mA what may be dangerous for the operator. The message will appear always when the current exceeds the 3.5 mA threshold and will automatically disappear after 10 s. For more obvious warning the message is accompanied with audio beep-beep signal.
IPE CURRENT OVERRANGE!	If IPE current is higher than 10 A for 10 s, the measurement will be stopped and this message will appear.
IL CURRENT OVERRANGE!	If IL current is higher than 16 A for 10 s, the measurement will be stopped and this message will appear.

5.10. PHASE SEQUENCE (PHASESEQ)

Correct phase sequence is important when e.g. 3-phase machines with mechanical rotation are connected to 3-phase mains installation.

5.10.1. PHASE SEQUENCE DISPLAY EXPLANATION

Adjustable/selectable parameters:

There are no adjustable/selectable parameters available!



Figure 39: Display with PHASE SEQUENCE test result

- 1..... Selected function.
- 2..... Measurement sub-results as follows: Phase-to-phase voltage $U_{L1/2}$, phase-to-phase voltage $U_{L2/3}$, phase-to-phase voltage $U_{L3/1}$.
- 3..... Measurement screen touch-screen key.
- 4..... Measurement result (in green colour - result OK, in red colour - result not OK).
- 5..... Real time clock (hh.mm.ss).

5.10.2. PHASE SEQUENCE MEASUREMENT

Measured quantities and display ranges:

Phase sequence	1.2.3. or 2.1.3.
Phase-to-phase voltage UL1/2	360 ÷ 460 V
Phase-to-phase voltage UL2/3	360 ÷ 460 V
Phase-to-phase voltage UL3/1	360 ÷ 460 V

- 1) Select the PHASESEQ function by pressing the **FUNC** hard key first.
- 2) Connect the test leads to tested socket/wiring according to the figure below.

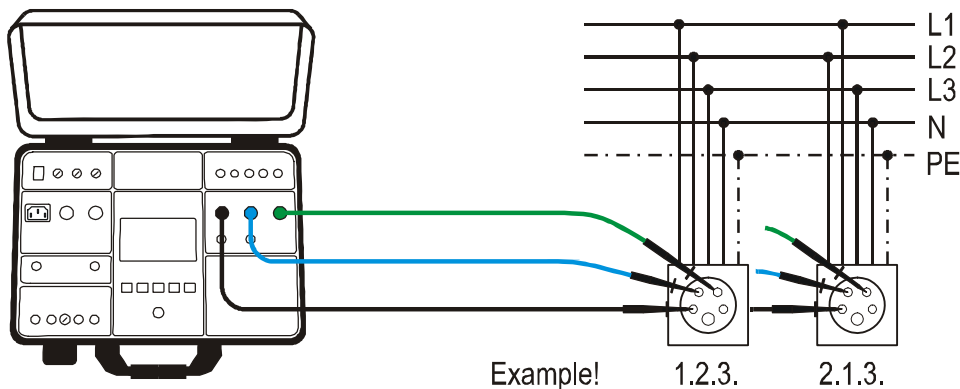

Figure 40: Connection of test leads in PHASE SEQUENCE measurement

- 3) Carry out the measurement by pressing the **START** button. The measurement will be done and test result will be displayed in green colour equipped with green thumbs up symbol and with beep-beep sound if it is in accordance with referential direction (1.2.3.). If the result is not in accordance with referential direction (2.1.3.) then it will be displayed in red colour equipped with red thumbs down symbol and with longer beep sound. See the display outlook with test result on the figure 38.
- 4) Save the test result by pressing the **SAVE** hard key twice, for further instructions see the "MEMORIZING EXAMPLE" section.
- 5) Press the **EXIT** hard key to clear displayed result, actual input voltages UL1/2, UL2/3, UL3/1 will start to be displayed again.

The following specific information can be shown on the display during the measurement:

Information displayed	Description
1.1.X	At least one of measured phases was disconnected during the measurement. <i>Connect all three phases and repeat the measurement.</i>

5.11. CURRENT MEASUREMENT USING CURRENT CLAMP (ICLAMP)

5.11.1. ICLAMP DISPLAY EXPLANATION

Adjustable/selectable parameters:

RANGE - measurement range	1000 mA, 100.0 A or 1000 A
LIMIT - limit value	0.1 ÷ 1000 mA (range 1000 mA)
	0.1 ÷ 100.0 A (range 100.0 A)
	1 ÷ 1000 A (range 1000 A)

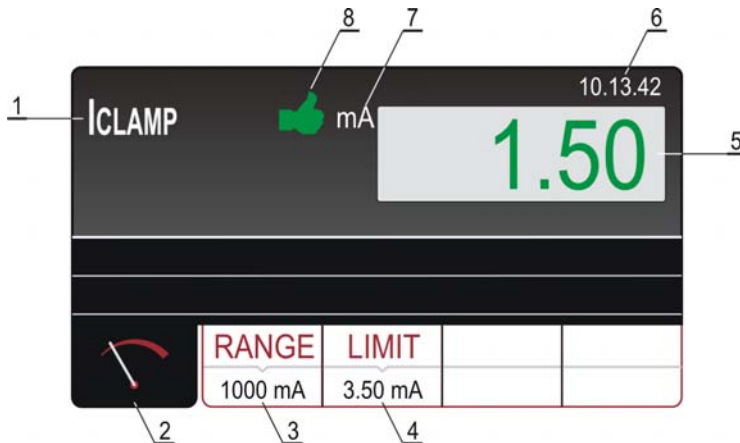





Figure 41: Display with ICLAMP test result

- 1..... Selected function.
- 2..... Measurement screen touch-screen key.
- 3..... **RANGE** touch-screen key to select measurement range (0 ÷ 1000 mA, 0 ÷ 100 A or 0 ÷ 1000 A).
- 4..... **LIMIT** touch-screen key to select limit current value inside each measurement range.
- 5..... Measurement result (in green colour - result OK, in red colour - result not OK).
- 5..... Real time clock (hh.mm.ss).
- 6..... Measurement result status (symbol  in green colour - result OK, symbol  in red colour - result not OK).

5.11.2. ICLAMP MEASUREMENT

Measured quantities and display ranges:

Clamp current ICLAMP	0 ÷ 1000 mA (range 1000 mA)
	0 ÷ 100 A (range 100 A)
	0 ÷ 1000 A (range 1000 A)

- 1) Select ICLAMP function by pressing the **FUNC** hard key first.
- 2) Check selected measurement range and modify it if needed by pressing the **RANGE** (3) touch-screen key first.
- 3) Check selected limit current and modify it if needed by pressing the **LIMIT** (4) touch-screen key first. Four independent preset limit values are available for quicker operations. Select the closest one and modify it by using the **+** and **-** touch screen keys if needed.
- 4) Select measurement screen by pressing the  (4) touch-screen key and check all settings again.
- 5) Connect current clamp to measured wiring according to the figure below.

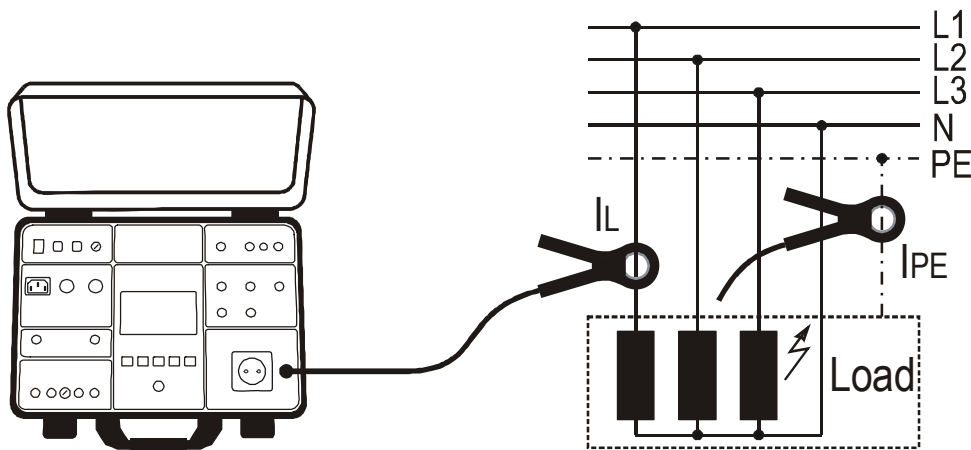



Figure 42: Connection of current clamp in ICLAMP measurement

- 6) Start the measurement by pressing the **START/STOP** button. The measurement will start to run and will be stopped after pressing the **START/STOP** button again. Measurement result will be currently displayed in green colour if it is lower than or equal to set limit value or in red colour if it is higher than set limit value. Final result will be equipped with green  symbol and with beep-beep sound if it is OK or with red  symbol and with longer beep sound if it is not OK. See the display outlook with test result on the figure 40.
- 7) Save the test result by pressing the **SAVE** hard key twice, for further instructions see the "MEMORIZING EXAMPLE" section.

CAUTION



- Max input voltage is 10 V, one terminal is grounded!
- Measurement time is limited to 60 min!

5.12. LEAKAGE CURRENT (ILEAK)

5.12.1. LEAKAGE CURRENT DISPLAY EXPLANATION

Adjustable/selectable parameters:

MODE - measurement mode	CLAMP or SOCKET
LIMIT - leakage current limit value	0.1 ÷ 100.0 mA, 101 ÷ 1000 mA (CLAMP mode, range 1000 mA) 0.1 ÷ 100.0 A (CLAMP mode, range 100.0 A) 1 ÷ 1000 A (CLAMP mode, range 1000 A) 0.01 ÷ 19.99 mA, 20.0 ÷ 49.9 mA, 0.05 ÷ 0.99 A, 1.0 ÷ 10.0 A (SOCKET mode)
RANGE - clamp measurement range	1000 mA, 100.0 A or 1000 A
L POS - phase position	LEFT or RIGHT

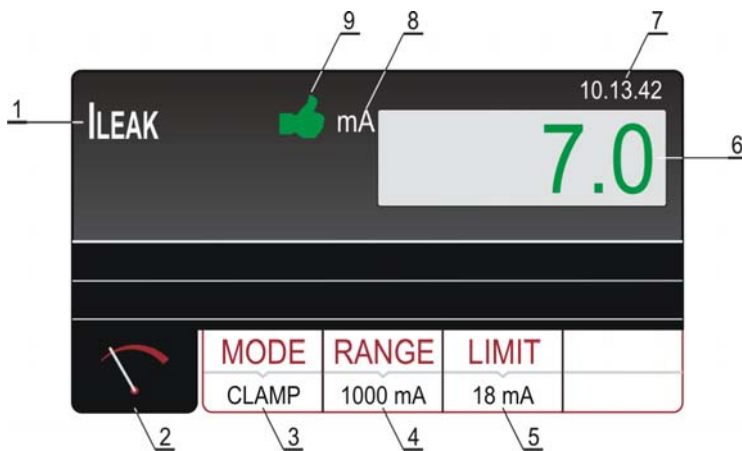

Figure 43: Display with ILEAK test result in CLAMP mode

- 1..... Selected function.
- 2..... Measurement screen touch-screen key.
- 3..... **MODE** touch-screen key to select measurement mode (SOCKET or CLAMP). Currently selected mode is displayed on the bottom of the key.
- 4..... **RANGE** touch-screen key to select the CLAMP measurement range. Currently selected range is displayed on the bottom of the key.
- 5..... **LIMIT** touch-screen key to select limit leakage current. Currently selected value is displayed on the bottom of the key.
- 6..... Measurement result (in green colour - result OK, in red colour - result not OK).
- 7..... Real time clock (hh.mm.ss).
- 8..... Unit of the test result.
- 9..... Measurement result status (symbol in green colour - result OK, symbol in red colour - result not OK).

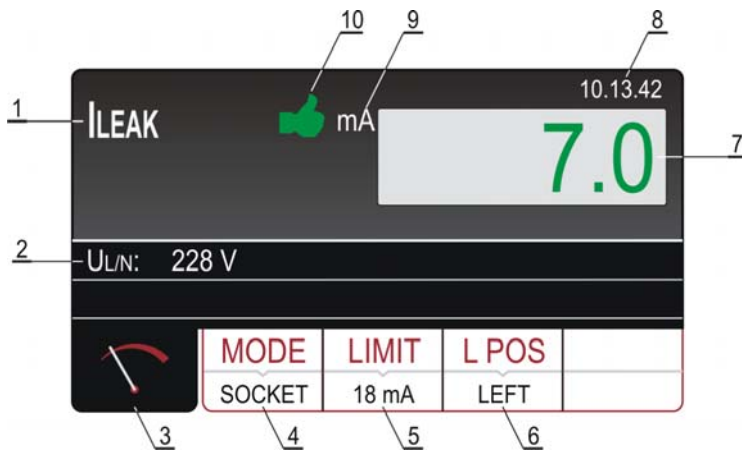



Figure 44: Display with ILEAK test result in SOCKET mode

- 1..... Selected function.
- 2..... Sub-result, mains voltage UL/N.
- 3..... Measurement screen touch-screen key.
- 4..... **MODE** touch-screen key to select measurement mode (SOCKET or CLAMP). Currently selected mode is displayed on the bottom of the key.
- 5..... **LIMIT** touch-screen key to select limit leakage current. Currently selected value is displayed on the bottom of the key.
- 6..... **L POS** touch-screen key to select the position of phase terminal on schuko socket during the measurement. Currently selected position is displayed on the bottom of the key.
- 7..... Measurement result (in green colour - result OK, in red colour - result not OK).
- 8..... Real time clock (hh.mm.ss).
- 9..... Unit of the test result.
- 10... Measurement result status (symbol  in green colour - result OK, symbol  in red colour - result not OK).

5.12.2. LEAKAGE CURRENT MEASUREMENT USING CURRENT CLAMP

Measured quantities and display ranges:

Leakage current I_{LEAK} measured by clamp

0 ÷ 1000 mA (1000 mA range)
0 ÷ 100 A (100 A range)
0 ÷ 1000 A (1000 A range)

- 1) Select I_{LEAK} function by pressing the **FUNC** hard key first.
- 2) Select CLAMP mode by pressing the **MODE** touch-screen key first.
- 3) Check selected measurement range and modify it if needed by pressing the **RANGE** (4) touch-screen key first.
- 4) Check selected limit leakage current by pressing the **LIMIT** (5) touch-screen key first. Four independent limit values are available for quicker operations. Select the closest one and modify it by using the + and – touch screen keys if needed.
- 5) Select measurement screen by pressing the  touch-screen key and check all settings again.
- 6) Connect the current clamp to measured wiring according to the figure below.

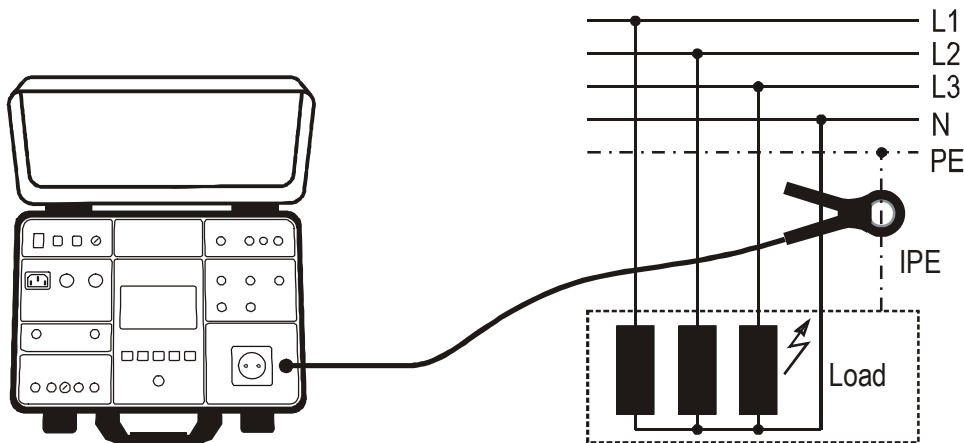





Figure 45: Connection of current clamp in I_{LEAK} measurement, CLAMP mode

- 7) Start the measurement by pressing the **START/STOP** button. The measurement will start to run and will be stopped after pressing the **START/STOP** button again. Measurement result will be currently displayed in green colour if it is lower than or equal to set limit value or in red colour if it is higher than set limit value. Final result will be equipped with green  symbol and with beep-beep sound if it is OK or with red  symbol and with longer beep sound if it is not OK. See the display outlook with test result on the figure 42.
- 8) Save the test result by pressing the **SAVE** hard key twice, for further instructions see the “MEMORIZING EXAMPLE” section.

5.12.3. LEAKAGE CURRENT MEASUREMENT ON SCHUKO SOCKET

Measured quantities and display ranges:

Leakage current IPE on schuko socket	0.25 mA ÷ 10 A
Mains voltage UL/N	195 ÷ 253 V

- 1) Select ILEAK measurement by pressing the **FUNC** hard key first.
- 2) Select SOCKET mode by pressing the **MODE** touch-screen key first.
- 3) Check selected limit leakage current by pressing the **LIMIT** (5) touch-screen key first. Four independent limit values are available for quicker operations. Select the closest one and modify it by using the **+** and **-** touch screen keys if needed.
- 4) Check selected position of phase terminal on schuko socket by pressing the **L POS** (6) touch-screen key. If LEFT position is selected then phase potential is connected to left terminal of schuko socket and vice versa.
- 5) Select measurement screen by pressing the  touch-screen key and check all settings again.
- 6) Connect the UUT to schuko socket according to the figure below.

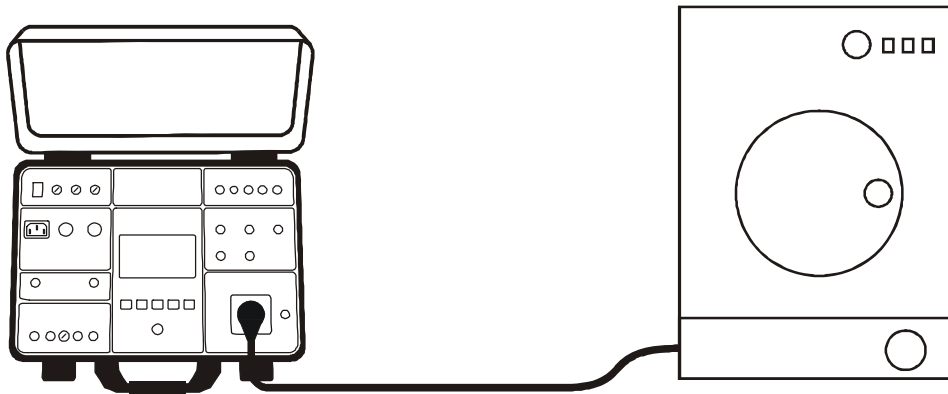



Figure 46: Connection of the UUT in ILEAK measurement, SOCKET mode

- 7) Start the measurement by pressing the **START/STOP** button. The measurement will start to run and will be stopped after pressing the **START/STOP** button again. Measurement result will be currently displayed in green colour if it is lower than or equal to set limit value or in red colour if it is higher than set limit value. Final result will be equipped with green  symbol and with beep-beep sound if it is OK or with red  symbol and with longer beep sound if it is not OK. See the display outlook with test result on the figure 43.
- 8) Save the test result by pressing the **SAVE** hard key twice, for further instructions see the "MEMORIZING EXAMPLE" section.

CAUTION



- Measurement at both phase positions (phase at left terminal and phase at right terminal) must be carried out and the highest value must be evaluated.
- Switch on the UUT in order total leakage current to be measured!
- In case of overloaded test socket the fuse F1 or F2 (both T16A/250V) may blow.
- Do not use test schuko socket except for measurement purpose!
- Measurement time (CLAMP and SOCKET) is limited to 60 min!

The following specific information can be shown on the display during the measurement:

Information displayed	Description
IPE CURRENT OVERRANGE!	If IPE current is higher than 10 A for 10 s, the measurement will be stopped and this message will appear.
IL CURRENT OVERRANGE!	If IL current is higher than 16 A for 10 s, the measurement will be stopped and this message will appear.

6. MENU FUNCTIONS

For further selection, entry and display of instrument's settings press the **MENU** hard key, the following MAIN MENU will appear.

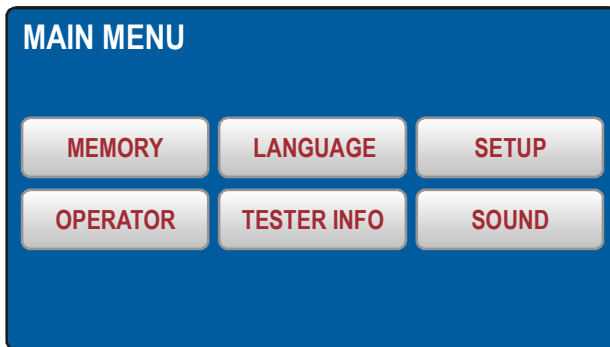

Figure 47: MAIN MENU

Press wished submenu touch-screen key for further settings.

6.1. MEMORY menu

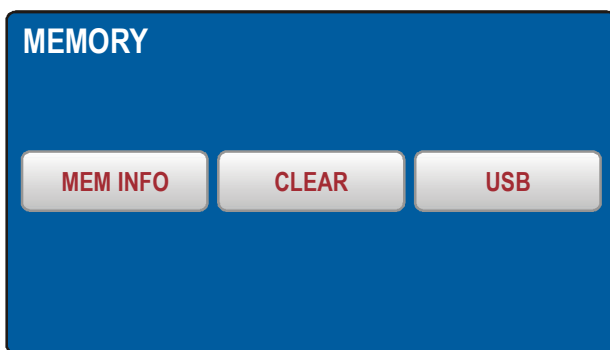

Figure 48: MEMORY menu

6.1.1. MEMORY INFO menu

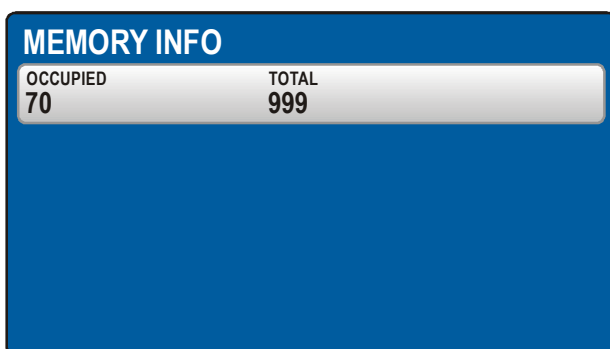

Figure 49: MEMORY INFO menu

Display of number of occupied and total memory locations. Each saved test result occupies one memory location.

6.1.2. CLEAR menu

In order to clear saved results the CLEAR menu shall be used.

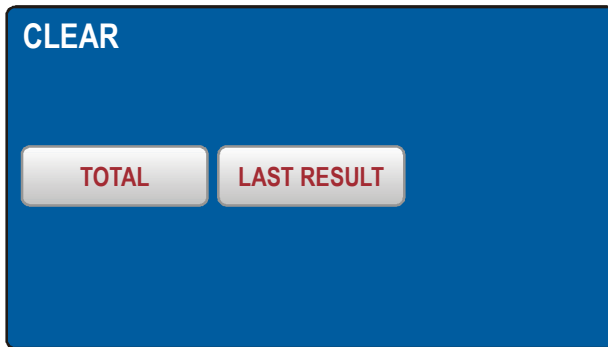

Figure 50: CLEAR menu

The whole memory (TOTAL) or only the last saved result (LAST RESULT) can be cleared. If the last result is cleared, then the result saved before the last one become to be the last and can be cleared too etc. Confirm clearing operation by pressing the **YES** touch-screen key.

6.1.3. USB menu

In order to transfer stored data to USB memory drive or to printer or to PC the USB menu shall be used. Insert the USB drive into USB2 or USB3 slot then press the USB touch-screen key. Confirm transferring by pressing the YES key.

6.2. OPERATOR menu



Figure 51: OPERATOR menu

How to select wished operator:

1. Check the list of available operators by using the ▼ and ▲ touch-screen keys (if there are more than 4 operators entered).
2. Select wished operator by pressing the operator's touch-screen key, e.g. **Default**. Marked operator is selected and will be used during the measurements.
3. Press the **ENTER** touch-screen key to confirm the selection and to exit the OPERATOR menu, MAIN MENU will be displayed again.

How to add a new operator:

4. Open OPERATOR menu and press the **ADD NEW** touch-screen key, the following display will appear.



Figure 52: ADD OPERATOR menu

5. Create new operator's name. Use the **123 / ABC** key to select figure or character selection screen.
6. Confirm entered name by pressing the **ENTER** touch-screen key. OPERATOR screen will appear again and last entered operator will be selected.

How to delete an operator:

7. Open OPERATOR menu, select the operator you wish to delete and press the **DELETE** touch-screen key. Confirm the deletion by pressing the **YES** touch-screen key.

6.3. LANGUAGE menu



Figure 53: LANGUAGE menu

Select wished language by pressing appropriate touch-screen key, the menu will turn to MAIN MENU.

6.4. TESTER INFO menu



Figure 54: TESTER INFO menu

TESTER INFO menu displays basic data of the tester like firmware version, hardware version, serial number and catalog number.

6.5. SETUP menu



Figure 55: SETUP menu

6.5.1. LEVEL NAMES menu

Three levels are available when saving test results i.e. LEVEL1, LEVEL2 and LEVEL3. In production the three levels are dedicated to CUSTOMER, LOCATION and MACHINE, but operator can rename them freely for example to DEVICE, DEPARTMENT and LOCATION. In order to do this the LEVEL NAMES menu shall be used.



Figure 56: LEVEL NAMES menu

Press the level touch-screen key you wish to rename for example **LEVEL 1**, the following menu will appear.



Figure 57: SET LEVEL NAME menu

Modify existing name and confirm it by pressing the **ENTER** touch-screen key, the menu will turn to LEVEL NAMES menu.

Repeat the operation for the other two levels if needed by following the same procedure.

6.5.2. CONTACT VOLTAGE menu

This menu shall be used in order to select limit contact voltage which is used in RCD and in RA measurements. The voltage may be either 25 or 50 V.



Figure 58: CONTACT VOL. menu

Select wished limit contact voltage by pressing appropriate touch-screen key, the menu will turn to SETUP menu.

6.5.3. DATE/TIME menu

In order to set date and time DATE/TIME menu shall be used.



Figure 59: DATE/TIME menu

Enter actual date and time by using the ,  and 0 ... 9 keys. Confirm it by pressing the **ENTER** touch-screen key. Time starts to run on this confirmation.

6.5.4. RESET menu

There are many adjustable parameters in the FULLTEST 3 tester. If an operator due to any reason wishes to reset all adjustable parameters to factory-set values, the operation can be done by using the RESET menu.

Confirm RESET operation by pressing the **YES** touch-screen key or press the **EXIT** hard key to exit the menu. Turn the tester off and on again by using the ON/OFF mains switch.

The following parameters have been reset.

Function	Parameter
GENERAL	<ul style="list-style-type: none"> - OPERATOR = Default - LANGUAGE = ITALIAN - CONTACT VOLTAGE = 50 V - NOMINAL VOLTAGE = 230 V - SAFETY INPUT = ENABLED - SOUND = ON
RPE-2WIRE	<ul style="list-style-type: none"> - I_m NOM = 200 mA - LIMIT value (200 mA) = 0.30 Ω - MODE = MANUAL - CAL (200 mA) = 0.00 Ω - LIMIT value 1 (200 mA) = 0.30 Ω - LIMIT value 2 (200 mA) = 1.00 Ω - LIMIT value 3 (200 mA) = 5.00 Ω - LIMIT value 4 (200 mA) = 50.0 Ω - LIMIT mode (25 A) = STANDARD - LIMIT value (25 A, STANDARD limit mode) = 0.30 Ω - LIMIT value 1 (25 A, STANDARD limit mode) = 0.30 Ω - LIMIT value 2 (25 A, STANDARD limit mode) = 1.00 Ω - LIMIT value 3 (25 A, STANDARD limit mode) = 5.00 Ω - LIMIT value 4 (25 A, STANDARD limit mode) = 10.0 Ω - LENGTH = 2 m - LENGTH 1 = 2 m - LENGTH 2 = 3 m - LENGTH 3 = 10 m - LENGTH 4 = 100 m - SECTION = 1 mm² - SECTION 1 = 1 mm² - SECTION 2 = 2.5 mm² - SECTION 3 = 10 mm² - SECTION 4 = 35 mm² - MAT. = Cu - ZLINE = 0.100 Ω - ZLINE 1 = 0.100 Ω - ZLINE 2 = 0.300 Ω - ZLINE 3 = 0.500 Ω - ZLINE 4 = 1.000 Ω - PROTECTION = MCB B - I_n (any protection) = 6 A - I_n (any protection) 1 = 6 A - I_n (any protection) 2 = 16 A - I_n (any protection) 3 = 25 A - I_n (any protection) 4 = 32 A - TIMER = 3 s - TIMER 1 = 3 s - TIMER 2 = 10 s - TIMER 3 = 30 min - TIMER 4 = 60 min - CAL (25 A) = 0.000 Ω

RPE-4WIRE	<ul style="list-style-type: none"> - LIMIT value (STANDARD limit mode) = 0.300 Ω - MODE → MANUAL - LIMIT value 1 (STANDARD limit mode) = 0.300 Ω - LIMIT value 2 (STANDARD limit mode) = 1.000 Ω - LIMIT value 3 (STANDARD limit mode) = 5.00 Ω - LIMIT value 4 (STANDARD limit mode) = 10.00 Ω - LENGTH = 2 m - LENGTH 1 = 2 m - LENGTH 2 = 3 m - LENGTH 3 = 10 m - LENGTH 4 = 100 m - SECTION = 1 mm² - SECTION 1 = 1 mm² - SECTION 2 = 2.5 mm² - SECTION 3 = 10 mm² - SECTION 4 = 35 mm² - MAT. = Cu - Z LINE = 0.100 Ω - ZLINE 1 = 0.100 Ω - ZLINE 2 = 0.300 Ω - ZLINE 3 = 0.500 Ω - ZLINE 4 = 1.000 Ω - PROTECTION = MCB B - IN (any protection) = 6 A - IN (any protection) 1 = 6 A - IN (any protection) 2 = 16 A - IN (any protection) 3 = 25 A - IN (any protection) 4 = 32 A - TIMER = 3 s - TIMER 1 = 3 s - TIMER 2 = 10 s - TIMER 3 = 30 min - TIMER 4 = 60 min
Riso	<ul style="list-style-type: none"> - MODE = MANUAL - Um NOM = 500 V - LIMIT value = 0.25 MΩ - TIMER = 5 s - TIMER 1 = 5 s - TIMER 2 = 10 s - TIMER 3 = 1 min - TIMER 4 = 10 min - LIMIT value 1 = 0.25 MΩ - LIMIT value 2 = 0.30 MΩ - LIMIT value 3 = 1.00 MΩ - LIMIT value 4 = 2.00 MΩ

DIELECTRIC	<ul style="list-style-type: none"> - MODE = MANUAL - UTEST NOM = 250 V - LIMIT value = 1 mA - CHAR = IAPP - UTEST NOM 1 = 250 V - UTEST NOM 2 = 1000 V - UTEST NOM 3 = 2500 V - UTEST NOM 4 = 3500 V - RAMP TIMER = 10 s - RAMP TIMER 1 = 10 s - RAMP TIMER 2 = 30 s - RAMP TIMER 3 = 1 min - RAMP TIMER 4 = 10 min - LIMIT value 1 = 1 mA - LIMIT value 2 = 10 mA - LIMIT value 3 = 50 mΩ - LIMIT value 4 = 100 mA
RCD	<ul style="list-style-type: none"> - TYPE = AC GEN - I_{ΔN} = 30 mA - MEAS = t/I_{ΔN} - POL = POS - DELAY = 100 ms - DELAY 1 = 100 ms - DELAY 2 = 200 ms - DELAY 3 = 300 ms - DELAY 4 = 700 ms
LOOP	<ul style="list-style-type: none"> - MODE = LOOP L/N - LIMIT mode = STD - I_b = 1 kA - I_b 1 = 1 kA - I_b 2 = 3 kA - I_b 3 = 6 kA - I_b 4 = 25 kA - PROTECTION = MCB B - I_n (any protection) = 6 A - I_n (any protection) 1 = 6 A - I_n (any protection) 2 = 16 A - I_n (any protection) 3 = 25 A - I_n (any protection) 4 = 32 A - MAT. = Cu - COATING = PVC - SECTION = 1 mm² - SECTION 1 = 1 mm² - SECTION 2 = 2.5 mm² - SECTION 3 = 10 mm² - SECTION 4 = 35 mm² - N = 1 - N 1 = 1 - N 2 = 10 - N 3 = 50 - N 4 = 75 - TSET = 0.2 s
RA	<ul style="list-style-type: none"> - Nominal differential current I_{ΔN} = 30 mA
URES	<ul style="list-style-type: none"> - CONNECTION = PLUG - MODE = LINEAR - LIMIT t = 5 s

POWER	<ul style="list-style-type: none"> - TIMER = 10 s - LIMIT apparent power = 6 VA - L POS = RIGHT - TIMER 1 = 10 s - TIMER 2 = 30 s - TIMER 3 = 1 min - TIMER 4 = 10 min - LIMIT apparent power 1 = 6 VA - LIMIT apparent power 2 = 100 VA - LIMIT apparent power 3 = 1.00 kVA - LIMIT apparent power 4 = 5.06 kVA
PHASE ROTATION	<ul style="list-style-type: none"> - None
ICLAMP	<ul style="list-style-type: none"> - RANGE = 1000 mA - LIMIT value (range 1000 mA) = 3.5 mA - LIMIT value 1 (range 1000 mA) = 3.5 mA - LIMIT value 2 (range 1000 mA) = 10.0 mA - LIMIT value 3 (range 1000 mA) = 100 mA - LIMIT value 4 (range 1000 mA) = 1000 mA - LIMIT value (range 100.0 A) = 6.0 A - LIMIT value 1 (range 100.0 A) = 6.0 A - LIMIT value 2 (range 100.0 A) = 16.0 A - LIMIT value 3 (range 100.0 A) = 50.0 A - LIMIT value 4 (range 100.0 A) = 100.0 A - LIMIT value (range 1000 A) = 6 A - LIMIT value 1 (range 1000 A) = 6 A - LIMIT value 2 (range 1000 A) = 160 A - LIMIT value 3 (range 1000 A) = 500 A - LIMIT value 4 (range 1000 A) = 1000 A
ILEAK	<ul style="list-style-type: none"> - MODE = CLAMP - RANGE = 1000 mA - LIMIT value (range 1000 mA) = 3.5 mA - LIMIT value 1 (CLAMP range 1000 mA) = 3.5 mA - LIMIT value 2 (CLAMP range 1000 mA) = 10.0 mA - LIMIT value 3 (CLAMP range 1000 mA) = 100 mA - LIMIT value 4 (CLAMP range 1000 mA) = 1000 mA - LIMIT value (CLAMP range 100.0 A) = 6.0 A - LIMIT value 1 (CLAMP range 100.0 A) = 6.0 A - LIMIT value 2 (CLAMP range 100.0 A) = 16.0 A - LIMIT value 3 (CLAMP range 100.0 A) = 50.0 A - LIMIT value 4 (CLAMP range 100.0 A) = 100.0 A - LIMIT value (CLAMP range 1000 A) = 6 A - LIMIT value 1 (CLAMP range 1000 A) = 6 A - LIMIT value 2 (CLAMP range 1000 A) = 160 A - LIMIT value 3 (CLAMP range 1000 A) = 500 A - LIMIT value 4 (CLAMP range 1000 A) = 1000 A - LIMIT value (SOCKET) = 3.50 mA - LIMIT value 1 (SOCKET) = 3.50 mA - LIMIT value 2 (SOCKET) = 10.00 mA - LIMIT value 3 (SOCKET) = 1.0 A - LIMIT value 4 (SOCKET) = 10.0 A

6.5.5. NOMINAL VOLTAGE menu

This menu shall be used in order to select nominal mains voltage. The voltage may be either 230 or 240 V. It is used in LOOP and URES measurements.

In LOOP measurements it is used for calculation of prospective short-circuit current, see the “LOOP IMPEDANCE / SHORT-CIRCUIT CURRENT (LOOP)” section.

In URES function (linear mode only) the nominal voltage is used for scaling of measured value, see the “RESIDUAL VOLTAGE (URES)” section.



Figure 60: NOMINAL VOL. menu

Select nominal voltage by pressing appropriate touch-screen key, the menu will turn to SETUP menu.

6.5.6. SAFETY menu

In order to set the status of safety input in DIELECTRIC function the SAFETY INPUT menu shall be used. The safety input may be enabled or disabled.

Safety input disabled: DIELECTRIC test is active regardless of the safety input condition (safety switch may be closed or opened or not connected at all).

Safety input enabled: DIELECTRIC test is active only if safety input condition is sufficient (safety switch must be closed).

This safety input status does not influence to any other function except DIELECTRIC.

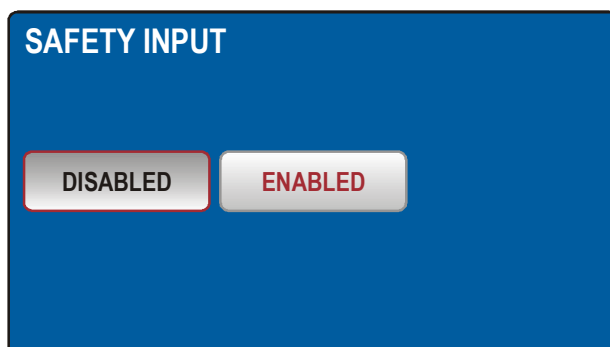

Figure 61: SAFETY INPUT menu

Select the safety status by pressing appropriate touch-screen key, the menu will turn to SETUP menu.

6.6. SOUND menu

In order to turn the acoustic signals off/on SOUND menu shall be used.



Figure 62: SOUND menu

Select the SOUND status by pressing appropriate touch-screen key, screen will turn to SETUP menu.

7. MEMORY FEATURES

Any memory address consists of three levels i.e. LEVEL 1 (in production set to CUSTOMER), LEVEL 2 (in production set to LOCATION) and LEVEL 3 (in production set to MACHINE). The memory address (at least LEVEL 1 i.e. CUSTOMER) should be entered after the first pressing the **SAVE** hard key. Additionally comment can be added to each saved result. Once the address is entered, it will be offered any time when save operation is activated. Serial number of saved result is added automatically chronologically. Date, time and operator are attached automatically, that is why it is important to check correct settings before carrying out the measurements.

7.1. MEMORY STRUCTURE

Measurement result, limit value and parameters are saved to selected memory address upon receiving the **SAVE** command. The following structure of the memory address is offered:

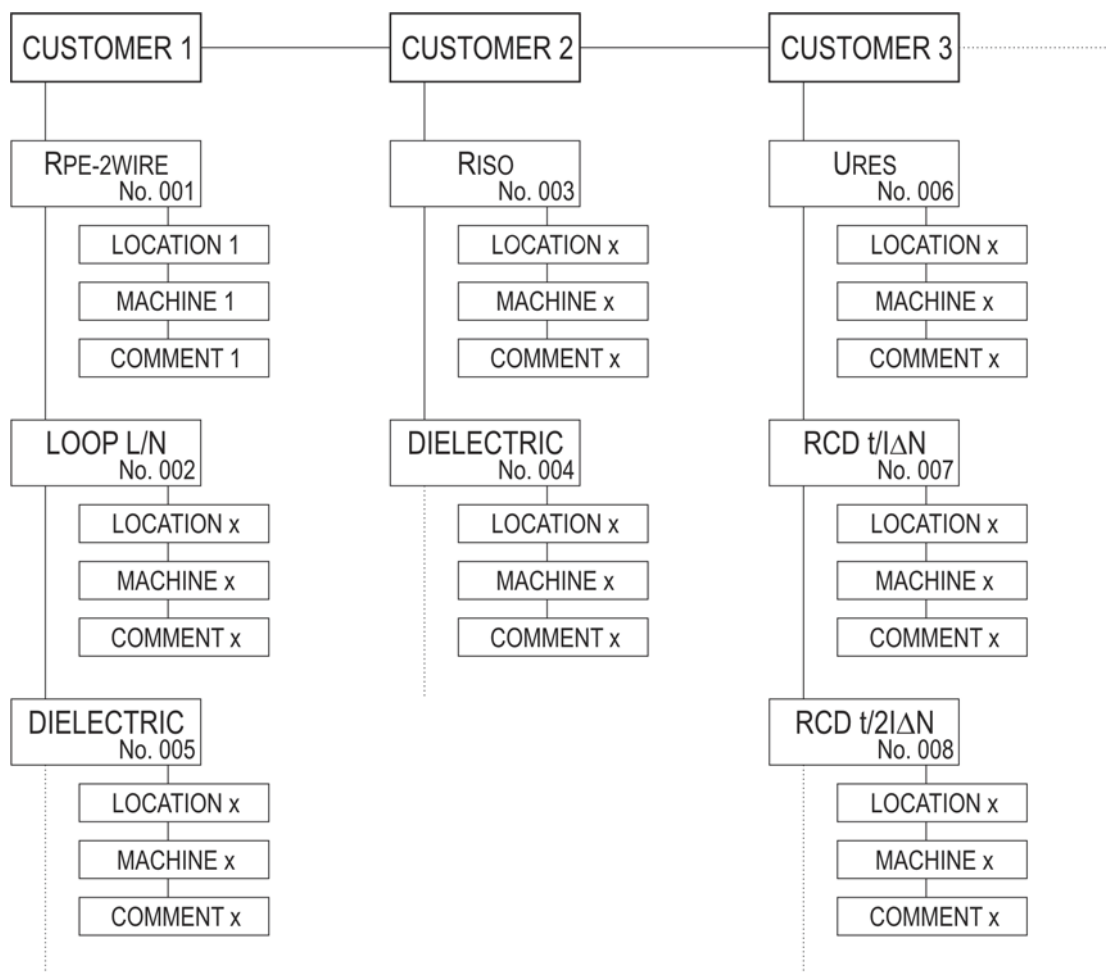

Figure 63: Storage structure

LEVEL1 (e.g. CUSTOMER):	Customer name (max. 12 characters)
LEVEL2 (e.g. LOCATION):	Location of the customer (max. 12 characters)
LEVEL3 (e.g. MACHINE):	Machine name (max. 12 characters)
NO.:	Serial number of saved result added automatically chronological way regardless of memory address.
COMMENT:	Comment (max. 30 characters)

8. MEMORIZING EXAMPLE

In order to save measurement result to a particular storage address, follow the next steps:

- 1) Carry out the measurement.
- 2) Press the **SAVE** hard key, the following display will appear (example):

Figure 64: SAVE menu

- 3) Confirm the save operation by pressing the **SAVE** hard key again if offered address (CUSTOMER, LOCATION and MACHINE) as well as COMMENT are OK. If offered address or comment is not OK then modify them as follows:
 8. Press the level key you wish to modify for example **CUSTOMER**, the following modification display will appear (example):

Figure 65: SAVE - SELECT CUSTOMER menu

9. Check the list of available customers by using the ▼ and ▲ touch-screen keys (if there are more than 4 customers entered).
10. Select wished customer by pressing the customer's touch-screen key, e.g. **CUSTOMER 4**.
11. Press the **ENTER** touch-screen key to confirm the selection and to exit the SAVE – SELECT CUSTOMER menu, SAVE menu will be displayed again.

If wished customer is not entered yet, then add a new one.

How to add a new customer:

12. Press the **ADD NEW** touch-screen key, the following display will appear.



Figure 66: ADD CUSTOMER menu

13. Create new customer's name. Use the **123 / ABC** key to select figure or character selection screen.
14. Confirm entered name by pressing the **ENTER** touch-screen key, SAVE – SELECT CUSTOMER screen will appear again and last entered operator will be selected.

Press the **ENTER** touch-screen key to confirm selected customer, SAVE menu will be offered again.

Repeat the operation for the other two levels and for comment if needed following the same procedure. In case of entering new LOCATION or MACHINE, previously selected name will be offered.

CAUTION



- When selecting LEVEL 2 (e.g. LOCATION) or LEVEL 3 (e.g. MACHINE), already used names and “BLANK” are offered, so the operator can select one of existing names or BLANK level directly (level 2 and level 3 are not required)!

Once all data (customer, location, machine and comment) are entered/selected press the **SAVE** hard key again to confirm started save operation. A beep-beep sound will follow as a confirmation save operation has successfully been accomplished. Measurement screen will be offered again.

CAUTION



- LEVEL 1 (e.g. CUSTOMER) must obligatory be entered when saving test result while LEVEL 2 (e.g. LOCATION), LEVEL 3 (e.g. MACHINE) and COMMENT are not required.
- Levels shall be selected/entered in order from the top (LEVEL 1) to the bottom (COMMENT). Do not skip empty level.

9. RECALL RESULTS

In order to recall saved measurement result, follow the next steps:

- 1) Press the **RCL** hard key, the following screen will appear (example).



Figure 67: RECALL menu

- 2) Check offered customer and if needed, select another one by pressing the **CUSTOMER** touch-screen key first. The following screen will appear.

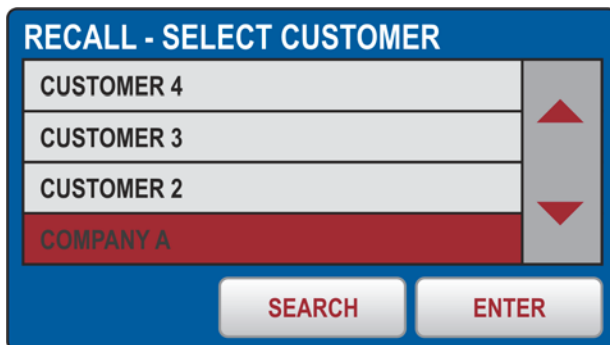

Figure 68: RECALL - SELECT CUSTOMER menu

15. Check the list of available customers by using the ▼ and ▲ touch-screen keys (if there are more than 4 customers entered).
16. Mark appropriate customer by pressing the customer touch-screen key, e.g. **CUSTOMER 3**.
17. Confirm the selection by pressing the **ENTER** touch-screen key, screen will turn to RECALL menu.

Note! If there is a list of many available customers use the SEARCH touch-screen key to select appropriate one quickly.

- 3) Select wished measurement by using the ▼ and ▲ keys.
- 4) Press the **RCL** hard key again, saved result will be displayed as follows.

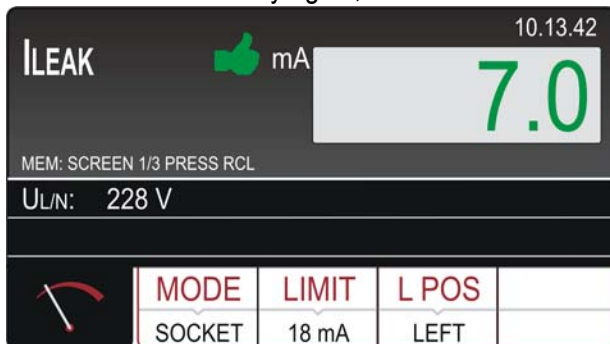

Figure 69: ILEAK function RECALL screen

- 5) Press the **RCL** hard key again in order to check next screens.

10. ENTRY OF DATA BY USING AN EXTERNAL KEYBOARD

The optional USB keyboard is a welcome accessory when inserting memory address construction (customer, machine and location) as well as comment, in order to do the job quickly and simply. Connect the USB keyboard to USB2 or USB3 connector, three sound signals will follow after plugging it, as a confirmation of USB-device recognition. Now, the external keyboard is operational.

11. ENTRY OF DATA BY USING A BARCODE READER

The optional USB barcode reader is a welcome accessory when inserting new customer, in order to do the job quickly and simply. Connect the USB barcode reader to USB2 or USB3 connector, three sound signals follow after plugging it, as a confirmation of USB device recognition.

Procedure:

- 1) Carry out the measurement.
- 2) Press the **SAVE** hard key, the following display will appear (example):

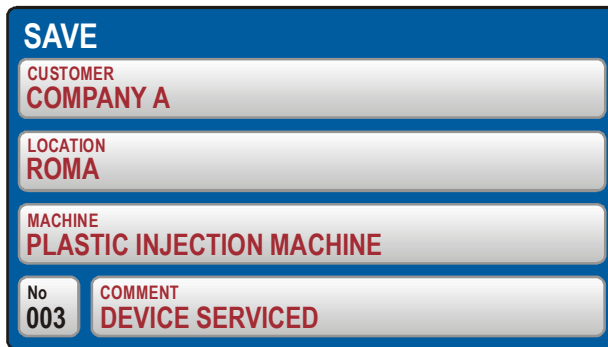

The screenshot shows a blue-bordered menu titled "SAVE". It contains four input fields with the following data: "CUSTOMER COMPANY A", "LOCATION ROMA", "MACHINE PLASTIC INJECTION MACHINE", and "No 003 COMMENT DEVICE SERVICED".

Figure 70: SAVE menu

- 3) Press the **CUSTOMER** touch-screen key, the following display will appear (example):

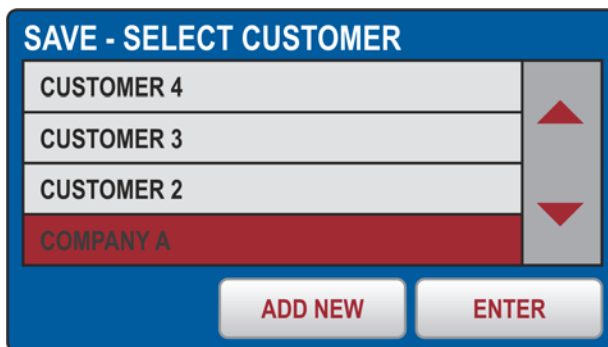

The screenshot shows a blue-bordered menu titled "SAVE - SELECT CUSTOMER". It features a list of customer names: "CUSTOMER 4", "CUSTOMER 3", "CUSTOMER 2", and "COMPANY A". The "COMPANY A" option is highlighted in red. To the right of the list are up and down arrow buttons. At the bottom, there are two buttons: "ADD NEW" and "ENTER".

Figure 71: SAVE - SELECT CUSTOMER menu

- 4) Press the **ADD NEW** touch-screen key, the following display will appear:



Figure 72: ADD CUSTOMER menu

- 5) Scan the customer label by using an USB barcode reader, customer name will be entered and display will return to SAVE menu, see the figure xx.
- 6) Modify or enter the other two save levels (LOCATION and MACHINE) as well as COMMENT manually if needed, then confirm save operation by pressing the SAVE hard key again.

Instruction how to configure the Barcode reader Honeywell type Voyager 1250G-2USB-1

Before first using the above mentioned barcode reader it is required to configure it as follows:

- Connect the barcode reader to FULLTEST 3 (or to PC) and switch on the FULLTEST 3 (or PC) in order to assure proper power supply.
- Do the start configuration of the barcode reader by scanning the code below.



- Set the prefix of the barcode reader by scanning the code below.



- Set the suffix of the barcode reader by scanning the code below.



- Finish the configuration of the barcode reader by scanning the code below.



- Switch the FULLTEST 3 tester off and on again after scanning above mentioned codes, the barcode reader and FULLTEST 3 are then ready to be used.

Note!

Use only the Barcode reader Honeywell type Voyager 1250G-2USB-1 otherwise it may not be recognized by the FULLTEST 3

12. FW UPDATE OF THE FULLTEST 3

The FW update can be done through USB drive, follow the next steps:

1. Download new FW version for example B03.M04.V02 from PC to USB drive.
2. Connect the USB drive to USB2 or USB3 connector of the FULLTEST 3, label DO YOU WISH TO UPDATE TO VERSION B03.M04.V02? will appear.
3. Confirm upload operation by pressing the **YES** touch-screen key.
4. Wait until the display returns to initial screen then remove the USB drive, new FW is thus installed.

13. MAINTENANCE

When using the instrument in compliance with the instruction manual, no special maintenance is required. However, should functional errors occur during normal operation, our after sales service will repair your instrument without delay.

13.1. CLEANING

If the tester is needed to be cleaned after daily usage, it is advisable to use a wet cloth and a mild household detergent.

Prior to cleaning, remove the machinery tester from all measurement circuits and from mains.

Never use acid-based detergents or dissolvent liquids for cleaning.

After cleaning it, do not use the instrument until it is completely dried up.

13.2. FUSE REPLACEMENT

If, due to overload or improper operation, a fuse blows, it is necessary to obey the following notes for replacement:

**WARNING**

Prior to replacement of blown fuse, the Machinery-Tester FULLTEST 3 must be disconnected from all measuring circuits and mains supply cord must be removed from mains supply socket.

- Use only fuses specified and rated in technical specifications.
- Use of unspecified fuses and in particular shortcircuiting fuse-holders is prohibited.
- Spare fuses can be obtained in electric supplies wholesale shops or in our factory service.

Fuse replacement (fuse F1, F2)

The two fuses are general mains ones for the tester and protect internal circuitry in POWER, RPE and DIELECTRIC measurements.

In case mains switch pilot lamp (5) does not illuminate after connecting the Machinery-Tester FULLTEST 3 to mains outlet and switching on the mains switch and neither the LC-Display (24) shows any indication, it is very likely mains fuse F1 (4) or F2 (3) or both to be blown.

To replace the fuse proceed as follows:

- 1) Open the fuse holder F1 (4) and F2 (3) by using an appropriate screwdriver.
- 2) Remove the defective fuse and replace it with a new one (T16A/250V, 5×20 mm).
- 3) Replace the fuse holder.

Fuse replacement (fuse F3 for LOOP, RA and RCD functions)

F3 (FF 12.5 A / 500 V, 6.3 × 32 mm) has blown if:

- Text FUSE F3 appears on the display in LOOP, RA or RCD function.

To replace the fuse proceed as follows:

- 1) Unlock corresponding fuse holder (2) by using an appropriate screwdriver
- 2) Remove the defective fuse and replace it with a new one (FF 12.5 A / 500 V, 6.3 × 32 mm).
- 3) Lock the fuse holder again.

Fuse replacement (fuse F4 for RPE function)

Fuse F4 (T20A/500V 6.3 x 32 mm) has blown if message FUSE F4 appears on the display in RPE function.

To replace the fuse proceed as follows:

- 1) Unlock corresponding fuse holder F4 (15) by using an appropriate screwdriver
- 2) Remove the defective fuse and replace it with a new one.
- 3) Replace the fuse holder.



If any fuse blows several times (for example in case of operating error) the instrument must be sent in to the service department in order to be checked.

14. TECHNICAL SPECIFICATIONS

14.1. MEASUREMENT FUNCTIONS

CONTINUITY OF PROTECTIVE CONDUCTOR (RPE-2WIRE, 0.2A)			
Display range (Ω)	Resolution (M Ω)	Accuracy	Overvoltage protection
0.00 ÷ 19.99	0.01	± (3% rdg. + 3 dgt)	CAT III 300 V
20.0 ÷ 200.0	0.1		

Standard test leads:	2 × 2 m, 2.5 mm ²
Open-circuit test voltage:	Approx. 4.5 V AC (floating)
Short-circuit test current:	< 0.6 A (standard test leads)
Test current:	> 0.2 A (standard test leads and external resistance < 20 Ω)
Display range of test current:	10 ÷ 255 mA
Accuracy of displayed test current:	± (3% rdg. + 2 dgt)
Limit value:	Adjustable 0.01 ÷ 19.99, 20.0 ÷ 200.0 Ω
Measurement principle:	Two-wire connection
Test lead calibration:	Up to 5.00 Ω
Protection against ext. voltage:	Fuse F4 (T20A/500V, 6.3×32 mm), blown fuse automatically detected in RPE measurement
Detection of external voltage	Yes <ul style="list-style-type: none"> - UEXT lim = 3 V AC (between two RPE or between two SENSE terminals before measurement) - UEXT lim = 10 V AC (between two RPE or between two SENSE terminals during measurement) - UEXT lim = 30 V AC approx. (between any RPE/SENSE terminal and GND before/during measurement)

CONTINUITY OF PROTECTIVE CONDUCTOR (RPE-2WIRE, 25A)			
Display range (Ω)	Resolution (M Ω)	Accuracy	Overvoltage protection
0.000 ÷ 1.999	0.001	± (3% rdg. + 3 dgt)	CAT III 300 V
2.00 ÷ 20.00	0.01		

Standard test leads:	2 × 2 m, 2.5 mm ²
Open-circuit test voltage:	Approx. 4.5 V AC (floating)
Short-circuit test current:	< 30 A (standard test leads)
Test current (25A range):	> 25 A (standard test leads and external resistance < 0.1 Ω) > 10 A (standard test leads and external resistance < 0.5 Ω)
Display range of test current:	0.2 ÷ 30.0 A
Accuracy of displayed test current:	± (3% rdg. + 1 dgt)
Limit value:	Adjustable 0.01 ÷ 20.00 Ω or Calculation through loop impedance or Calculation through wire length
Measurement principle:	Two-wire connection
Test lead calibration:	Up to 5.00 Ω
Protection against ext. voltage between current terminals (RPE):	Fuse F4 (T20A/500V, 6.3×32 mm), blown fuse automatically detected
Detection of external voltage	Yes, see the limit values explanation above (PROTECTIVE CONDUCTOR (RPE-2WIRE, 0.2A))

Continuity of protective conductor (RPE-4WIRE, 25A)			
Display range (Ω)	Resolution ($M\Omega$)	Accuracy	Overvoltage protection
0.000 ÷ 1.999	0.001	\pm (3% rdg. + 3 dgt)	CAT III 300 V
2.00 ÷ 20.00	0.01		

Standard test leads:	2 × 2 m, 2.5 mm ²
Open-circuit test voltage:	Approx. 4.5 V AC (floating)
Short-circuit test current:	< 30 A (standard test leads)
Test current (25A range):	> 25 A (standard test leads and external resistance < 0.1 Ω) > 10 A (standard test leads and external resistance < 0.5 Ω)
Display range of test current:	0.2 ÷ 30.0 A
Accuracy of displayed test current:	\pm (3% rdg. + 1 dgt)
Limit value:	Adjustable 0.01 ÷ 20.00 Ω or Calculation through loop impedance or Calculation through wire length
Measurement principle:	Four-wire connection
Protection against ext. voltage:	Fuse F4 (T20A/500V, 6.3×32 mm), blown fuse automatically detected
Detection of external voltage	Yes, see the limit values explanation above (PROTECTIVE CONDUCTOR (RPE-2WIRE, 0.2A))

Insulation resistance (M Ω)				
DC test voltage (V)	Display range (M Ω)	Resolution (M Ω)	Accuracy	Overvoltage protection
100	0.00 ÷ 9.99	0.01	± (3% rdg. + 3 dgt)	CAT III 300 V
	10.0 ÷ 20.0	0.1		
	20.0 ÷ 99.9	0.1	± 5% rdg.	
250	0.00 ÷ 9.99	0.01	± (3% rdg. + 3 dgt)	
	10.0 ÷ 20.0	0.1		
	20.0 ÷ 99.9	0.1	± 5% rdg.	
	100 ÷ 250	1		
500	0.00 ÷ 9.99	0.01	± (3% rdg. + 3 dgt)	
	10.0 ÷ 20.0	0.1		
	20.0 ÷ 99.9	0.1	± 5% rdg.	
	100 ÷ 500	1		
1000	0.00 ÷ 9.99	0.01	± (3% rdg. + 3 dgt)	
	10.0 ÷ 20.0	0.1		
	20.0 ÷ 99.9	0.1	± 5% rdg.	
	100 ÷ 1000	1		

Test voltage tolerance:

(-0% ÷ +25%) of UN

Test current:

> 1 mA (up to UN/1mA)

Short-circuit current:

< 15 mA

Discharge:

Internal resistance of 2 M Ω (after finishing the measurement)

Detection of external voltage

Yes

- UEXT lim = 10 V AC (between RISO+ and RISO- terminals before measurement)
- UEXT lim = 50 V AC (between RISO+ and RISO- terminals during measurement)
- UEXT lim = 50 V AC approx. (between any RISO terminal and GND)
- UEXT lim = -10 V DC (between RISO+ and RISO- terminals during measurement)

Dielectric withstanding test (DIELECTRIC)				
Nominal test voltage U_N (V)	Output	Resolution (V)	Accuracy of output voltage	Overvoltage protection
250 ÷ 800	COM & 0.25÷0.80 kV	10	± 3% U_N	CAT III 300 V
810 ÷ 2500	COM & 0.81÷2.50 kV			
2510 ÷ 5100	COM & 2.51÷5.10 kV			

Nominal test voltage U_N : Adjustable 250 ÷ 5100 V, 50/60 Hz (floating) in steps of 10 V
 Distortion of test voltage: Crest factor = $1.414 \pm 5\%$
 Measurement modes: MANUAL, RAMP (timer) or BURN
 Output power: 500 VA at 5100 V

Leakage current IAPP:

Display range (mA)	Resolution (mA)	Accuracy
0 ÷ 200	1	± (3% rdg + 2 mA)

Leakage current IREAL:

Display range (mA)	Resolution (mA)	Accuracy
0 ÷ 110	1	± (3% rdg + 4 mA)

Nominal breaking current (IAPP or IREAL): Adjustable 1 ÷ 110 mA in steps of 1 mA
 Short-circuit current: > 200 mA
 Breaking time: < 30 ms

Note!

Always connect COM terminal to GND if measured OUT is grounded, otherwise possible capacitive leakage current may flow to ground which may disturb the measurement!

RCD test (RCD)

RCD types / characteristics:	AC, A or B / General, Selective or Delayed
Measurement modes:	$x1/2I_{\Delta N}$, $x1I_{\Delta N}$, $x2I_{\Delta N}$, $xKI_{\Delta N}$ ($K = 4$ B type, $K=5$ AC, A type), I_{Δ} (RAMP), AUTO (sequence: $x1/2$, $x1$, xK)
Nominal currents:	10, 30, 100, 300, 500, 650 or 1000 mA
Accuracy of test currents (10 mA):	- 10% / + 0% ($I_{\Delta N}/2$) + 10% / - 0% ($I_{\Delta N}$, $2I_{\Delta N}$, $KI_{\Delta N}$)
Accuracy of test currents (30÷1000 mA):	- 5% / + 0% ($I_{\Delta N}/2$) + 5% / - 0% ($I_{\Delta N}$, $2I_{\Delta N}$, $KI_{\Delta N}$)
Input voltage range / frequency:	100 ÷ 265 V / (50 / 60 Hz) ± 0.5 Hz
Contact voltage limits:	25 V or 50 V selectable
Test current polarity:	POSITIVE or NEGATIVE selectable

Test duration (ms) – TT/TN system:

$I_{\Delta N}$ (mA)		$\times 1/2$	$\times 1$	$\times 2$			$\times K$			AUTO			RAMP		
		G, S, D	G, S, D	G	S	D	G	S	D	G	S	D	G	S	D
10 30 100	AC	1000	1000	200	250		50	150		✓	✓		320		
	A	1000	1000	200	250		50	150		✓	✓		320		
	B	1000	1000				200	250		✓	✓		320		
300	AC	1000	1000	200	250		50	150		✓	✓		320		
	A	1000	1000	200	250		50	150		✓	✓		320		
	B	1000	1000										320		
500	AC	1000	1000	200	250		50	150		✓	✓		320		
	A	1000	1000	200	250								320		
	B	1000	1000										320		
650	AC	1000	1000	200	250		50	150		✓	✓		320		
	A	1000	1000	200	250								320		
	B	1000													
1000	AC	1000	1000	200	250								320		
	A	1000	1000												
	B	1000													

Resolution: 1ms, Accuracy: ± (3% rdg + 2 ms)

Mains voltage UL/N, UL/PE:

Display range (V)	Resolution (V)	Accuracy
100 ÷ 265	1	± (3% rdg.)

Input resistance (UL/N, UL/PE): 450 kΩ

Ramp test:	YES, current range 10 ÷ 110% of $I_{\Delta N}$ in steps of 5% of $I_{\Delta N}$
AUTO TEST:	YES, test steps are as follows: <ul style="list-style-type: none"> - $t/I_{\Delta N}/2$ (pos. polarity) - $t/I_{\Delta N}/2$ (neg. polarity) - $t/I_{\Delta N}$ (pos. polarity) - $t/I_{\Delta N}$ (neg. polarity) - $t/5I_{\Delta N}$, (pos. polarity) - $t/5I_{\Delta N}$ (neg. polarity)

LOOP impedance / Short-circuit current (LOOP)			
Display range (Ω)	Resolution (M Ω)	Accuracy	Overvoltage protection
*0.000 ÷ 2.000	0.001	± (3% rdg. + 3 dgt)	CAT III 300 V
0.00 ÷ 9.99	0.01		
10.0 ÷ 99.9	0.1		
100 ÷ 200	1		

* With optional accessory IMP57 only!

Input voltage range LOOP L/PE or L/N: 100 ÷ 265 V, 50/60 Hz

Input voltage range LOOP L/L: 173 ÷ 460 V, 50/60 Hz

Nominal mains voltage: 230 or 240 V

Loading resistance: 10 Ω for 20 ms (range 0.00 ÷ 30.0 Ω) and
180 Ω for 20 ms (range 30.0 ÷ 200.0 Ω)

ISC calculation: Depends on selected limit mode

Short-circuit current ISC:

Display range (A)	Resolution (A)	Accuracy
0.05 ÷ 0.99	0.01	Depends on UL/PE and Z accuracy
1.0 ÷ 99.9	0.1	
100 ÷ 999	1	
1.00k ÷ 46.00k	10	

Mains voltage UL/N, UL/PE:

Display range (V)	Resolution (V)	Accuracy
100 ÷ 265	1	± (3% rdg.)

Input resistance (UL/N, UL/PE): 450 k Ω

Mains voltage UL/L:

Display range (V)	Resolution (V)	Accuracy
100 ÷ 460	1	± (3% rdg.)

Input resistance (UL/N, UL/PE): 450 k Ω

Global earth resistance without tripping RCD (RA)				
I _{ΔN} (mA)	Display range RA (Ω)	Resolution (Ω)	Accuracy	Overvoltage protection
10	0 ÷ 2000	1	± (3% rdg. + 1 Ω), 15 ÷ 2000 Ω*	CAT III 300 V
30	0.0 ÷ 99.9	0.1	± (3% rdg. + 1 Ω), 10 ÷ 2000 Ω*	
	100 ÷ 2000	1		
100	0.0 ÷ 99.9	0.1	± (3% rdg. + 3 dgt)*	
	100 ÷ 1000	1		
300	0.0 ÷ 99.9	0.1		
	100 ÷ 300	1		
500	0.0 ÷ 99.9	0.1		
	100 ÷ 200	1		
650	0.0 ÷ 99.9	0.1		
	100 ÷ 150	1		
1000	0.0 ÷ 100.0	0.1		

* The accuracy may be affected unstable mains voltage!

Test current: $I_{\Delta N} / 2$
 Input voltage range: 100 ÷ 265 V, 50/60 Hz
 Nominal mains voltage : 230 or 240 V

Mains voltage UL/PE:

Display range (V)	Resolution (V)	Accuracy
100 ÷ 265	1	± (3% rdg.)

Input resistance (UL/PE): 450 kΩ

Contact voltage UC at I_{ΔN}:

Display range (V)	Resolution (V)	Accuracy
0 ÷ 100 (UC LIM = 50 V)	1	± (3% rdg. + 3 V)
0 ÷ 50 (UC LIM = 25 V)		

TRMS Residual voltage (URES)			
Display range	Resolution (V)	Accuracy (general)	Overvoltage protection
10 ÷ 460 V	1	± (3% rdg. + 3 V)	CAT III 300 V
10 ÷ 650 V			

Input voltage (UTRIG): 0 ÷ 460 V AC
 Nominal mains voltage : 230 or 240 V
 Measurement method: 4-wire connection (INTERNAL measurement, 1 s or 5 s)
 2-wire connection (PLUG measurement, 1 s)
 Residual voltage limit value: 60 V RMS

Input voltage URES:

Display range (V)	Resolution (V)	Accuracy
10 ÷ 460 V AC	1	± (2% rdg. + 2 V)
10 ÷ 650 V DC		

Input resistance (URES): 100 MΩ

Input voltage UTRIG:

Display range (V)	Resolution (V)	Accuracy
10 ÷ 265 V AC	1	± (2% rdg. + 2 V)

Input resistance (UTRIG): 450 kΩ

TRMS Load Current (POWER)			
Display range A	Resolution A	Accuracy	Overvoltage protection
0.00 ÷ 0.99	0.01	± (3% rdg. + 3 dgt)	CAT II 300 V
1.0 ÷ 20.0	0.1		

Frequency range 15 ÷ 723 Hz
 Over-range limit Yes, the measurement will be automatically interrupted 10 s after exceeding 16 A
 Pre-Test Grounding of PE terminal on wall schuko socket

TRMS Mains Voltage (POWER)			
Display range V	Resolution V	Accuracy	Overvoltage protection
195 ÷ 253	1	± (2% rdg. + 2 dgt)	CAT II 300 V

Frequency range 15 ÷ 723 Hz

Apparent Power / Active Power (POWER)			
Display range VA/W	Resolution VA/W	Accuracy	Overvoltage protection
0.0 ÷ 99.9	0.1	± (5% rdg. + 10 dgt)	CAT II 300 V
100 ÷ 999	1	± (5% rdg. + 3 dgt)	
1.00 ÷ 5.06 k	10		

Limit value PAPP Adjustable 6 ÷ 999 VA, 1.00 kVA ÷ 5.06 kVA

Power factor (POWER)			
Display range	Resolution	Accuracy	Overvoltage protection
0.00 ÷ 1.00	0.01	Respect the accuracy of PAPP and PACT	CAT II 300 V

TRMS Leakage Current IPE (POWER)			
Display range	Resolution	Accuracy	Overvoltage protection
0.25 ÷ 19.99 mA	0.01 mA	± (3% rdg. + 3 dgt)	CAT II 300 V
20.0 ÷ 49.9 mA	0.1 mA		
0.05 ÷ 0.99 A	0.01 A		
1.0 ÷ 10.0 A	0.1 A		

Load current influence	± 0.01 mA / A
Frequency range	40 Hz ÷ 723 Hz (characteristics according to IEC 61557-13)
Measurement method	Differential
Mains cord polarity exchange	Internally by using the L POS key
UUT mains on switch test	Yes, the test done by measuring L current, limit value 25 mA
Over-range limit (IPE)	Yes, the measurement will be automatically interrupted 10 s after exceeding 10 A
Over-range limit (IL)	Yes, the measurement will be automatically interrupted 10 s after exceeding 18 A

PHASE SEQUENCE (PHASESEQ)			
Display range UL1/2, UL2/3, UL3/1 (V)	Resolution (V)	Accuracy	Overvoltage protection
360 ÷ 460	1	± (2% rdg. + 2 dgt)	CAT III 300 V

Display of test result: 1.2.3 (right) or 2.1.3 (left) or 1.1.X (not defined)

TRMS Clamp Current (ICLAMP)				
Range	Display range	Resolution	Accuracy (w/o clamp error)	Overvoltage protection
1000 mA	0.0 ÷ 99.9 mA	0.1 mA	± (3% rdg. + 3 dgt)	One measurement terminal grounded
	100 ÷ 1000 mA	1 mA		
100.0 A	0.00 ÷ 9.99 A	0.01 A		
	10.0 ÷ 100.0 A	0.1 A		
1000 A	0.0 ÷ 99.9 A	0.1 A		
	100 ÷ 1000 A	1 A		

Input voltage range:	0 ÷ 1 V AC
Input resistance:	1 MΩ
Frequency range:	40 Hz ÷ 723 Hz* (characteristics according to IEC 61557-13)
Clamp type:	AC, output voltage 1 V / measuring range, type HT96U (measuring ranges 1 A, 100 A, 1000 A)
LIM value (1000 mA range):	Adjustable 0.1 ... 99.9 mA, 100 ... 1000 mA
LIM value (100.0 A range):	Adjustable 0.1 ... 100.0 A
LIM value (1000 A range):	Adjustable 1 ... 1000 A
*clamp frequency range is not included	

TRMS Leakage current using current clamp (I _{LEAK})				
Range	Display range	Resolution	Accuracy (w/o clamp error)	Overvoltage protection
1000 mA	0.0 ÷ 99.9 mA	0.1 mA	± (3% rdg. + 3 dgt)	One measurement terminal grounded
	100 ÷ 1000 mA	1 mA		
100.0 A	0.00 ÷ 9.99 A	0.01 A		
	10.0 ÷ 100.0 A	0.1 A		
1000 A	0.0 ÷ 99.9 A	0.1 A		
	100 ÷ 1000 A	1 A		

Input voltage range: 0 ÷ 1 V AC
 Input resistance: 1 MΩ
 Frequency range: 40 Hz ÷ 723 Hz* (characteristics according to IEC 61557-13)
 Clamp type: AC, output voltage 1 V / measuring range, type HT96U (measuring ranges 1 A, 100 A, 1000 A)
 LIM value (1000 mA range): Adjustable 0.1 ... 99.9 mA, 100 ... 1000 mA
 LIM value (100.0 A range): Adjustable 0.1 ... 100.0 A
 LIM value (1000 A range): Adjustable 1 ... 1000 A
 *clamp frequency range is not included

TRMS Leakage Current on test socket (I _{LEAK})			
Display range	Resolution	Accuracy	Overvoltage protection
0.25 ÷ 49.99 mA	0.01 mA	± (3% rdg. + 3 dgt)*	CAT II 300 V
0.05 ÷ 0.99 A	0.01 A		
1.0 ÷ 10.0 A	0.1 A		

* Clamp error not included
 Load current influence ± 0.01 mA / A
 Limit value Adjustable 0.25 ÷ 19.99 mA, 20.0 ÷ 49.9 mA, 0.05 ÷ 0.99 A, 1.0 ÷ 10.0 A
 Frequency range 40 Hz ÷ 723 Hz (characteristics according to IEC 61557-13)
 Measurement method Differential
 Mains cord polarity exchange Internally by using the L POS key
 UUT mains ON switch test Yes, the test done by measuring L current, limit value 25 mA
 Over-range limit (IPE) Yes, the measurement will be automatically interrupted 10 s after exceeding 10 A
 Over-range limit (IL) Yes, the measurement will be automatically interrupted 10 s after exceeding 18 A
 Pre-Tests

- Grounding of PE terminal on wall schuko socket
- Status of ON/OFF mains switch on UUT (measurement of power consumption on schuko test socket, limit value 6 VA)

14.2. GENERAL SPECIFICATION

POWER SUPPLY

Mains voltage:	207 ÷ 253 V / 50/60 Hz ± 5%
Current consumption:	16 Amax

MECHANICAL SPECIFICATIONS

Dimensions (L x W x H):	400 x 300 x 170 mm
Weight:	15 kg

MEMORY AND INPUT/OUTPUT INTERFACES

Internal memory:	999 locations (three-level memory structure)
PC interface:	USB 2.0 device, connector type "B"
USB keyboard, USB printer, pen drive, USB barcode reader:	2 x USB 2.0 host, connector type "A"
Pen drive requirements:	FAT12, FAT16 or FAT32 with a sector size of 512 Byte
Warning lamp:	For dielectric test
Keyboard for remote controls	
START/STOP/SAVE keys:	Yes
Bluetooth interface connection:	Yes

ENVIRONMENTAL CONDITIONS

Reference temperature:	23°C ± 5°C
Working temperature:	0° ÷ 40°C
Reference humidity:	< 60% RH w/o condensation
Working humidity:	< 80% RH w/o condensation
Storage temperature:	-10 ÷ 60°C
Storage humidity:	< 80% RH w/o condensation

REFERENCE GUIDELINES

Safety tests machines/ switchboards/devices:	IEC/EN60204-1:2006; IEC/EN61439-1; IEC/EN60335-1
Literature:	IEC/EN61187
Instrument:	IEC/EN61557-1-2-3-4-6-13-14

GENERAL CHARACTERISTICS

Display:	4.3 inch colour TFT LCD with touch screen,
Limit value setting:	See each function separately
Warning in case of exceeded	
Limit values:	Optic and acoustic warning in case of exceeded value
Instrument safety:	IEC/EN61010-1
Insulation:	Protection class I (protection conductor)
Pollution degree:	2
Measurement category:	CAT II 300V (Power), CAT III 300V (other tests)
Altitude above sea level:	2000 m
Mechanical protection:	IP40

14.3. ACCESSORIES

Please see enclosed packing list.

15. SERVICE

15.1. WARRANTY CONDITIONS

This instrument is guaranteed against material or production defects, in accordance with our general sales conditions. During the warranty period the manufacturer reserves the right to decide either to repair or replace the product.

Should you need for any reason to return back the instrument for repair or replacement take prior agreements with the local distributor from whom you bought it. Do not forget to enclose a report describing the reasons for returning (detected fault). Use only original packaging. Any damage occurred in transit due to non original packaging will be charged anyhow to the customer.

The manufacturer will not be responsible for any damage to persons or things.

Accessories (not covered by warranty).

The warranty does not apply to:

- Repairs made necessary by improper use (including adaptation to particular applications not foreseen in the instructions manual) or improper combination with incompatible accessories or equipment.
- Repairs made necessary by improper shipping material causing damages in transit.
- Repairs made necessary by previous attempts for repair carried out by non skilled or unauthorized personnel.
- Instruments for whatever reason modified by the customer himself without explicit authorization of our Technical Dept.
- The contents of this manual may not be reproduced in any form whatsoever without the manufacturer's authorization.

Our products are patented and our logotypes registered. We reserve the right to modify specifications and prices in view of technological improvements or developments which might be necessary.

15.2. AFTER-SALE SERVICE

Shouldn't the instrument work properly, before contacting your distributor make sure that batteries are correctly installed and working, check the test leads and replace them if necessary. Make sure that your operating procedure corresponds to the one described in this manual.

Should you need for any reason to return back the instrument for repair or replacement take prior agreements with the local distributor from whom you bought it. Do not forget to enclose a report describing the reasons for returning (detected fault). Use only original packaging. Any damage occurred in transit due to non original packaging will be charged anyhow to the customer.

The manufacturer will not be responsible for any damage to persons or things.

Subject to technical changes without notice!

optec

energie ist messbar

Optec AG | Guyer-Zeller-Strasse 14 | CH-8620 Wetzikon ZH

Telefon: +41 44 933 07 70 | Telefax: +41 44 933 07 77

E-Mail: info@optec.ch | Internet: www.optec.ch



HT INSTRUMENTS SA

C/ Legalitat, 89
08024 Barcelona - **ESP**
Tel.: +34 93 408 17 77, Fax: +34 93 408 36 30
eMail: info@htinstruments.com
eMail: info@htinstruments.es
Web: www.htinstruments.es

HT INSTRUMENTS USA LLC

3145 Bordentown Avenue W3
08859 Parlin - NJ - **USA**
Tel: +1 719 421 9323
eMail: sales@ht-instruments.us
Web: www.ht-instruments.com

HT ITALIA SRL

Via della Boaria, 40
48018 Faenza (RA) - **ITA**
Tel: +39 0546 621002
Fax: +39 0546 621144
eMail: ht@htitalia.it
Web: www.ht-instruments.com

HT INSTRUMENTS GMBH

Am Waldfriedhof 1b
D-41352 Korschenbroich - **GER**
Tel: +49 (0) 2161 564 581
Fax: +49 (0) 2161 564 583
eMail: info@ht-instruments.de
Web: www.ht-instruments.de

HT INSTRUMENTS BRASIL

Rua Aguçu, 171, bl. Ipê, sala 108
13098321 Campinas SP - **BRA**
Tel: +55 19 3367.8775
Fax: +55 19 9979.11325
eMail: vendas@ht-instruments.com.br
Web: www.ht-instruments.com.br

HT ITALIA CHINA OFFICE

意大利HT中国办事处
Room 3208, 490# Tianhe road, Guangzhou - **CHN**
地址: 广州市天河路490号壬丰大厦3208室
Tel.: +86 400-882-1983, Fax: +86 (0) 20-38023992
eMail: zenglx_73@hotmail.com
Web: www.guangzhouht.com